

ASTRA

PRICE/SPECIFICATION GUIDE

1 January 2019 | Model Year 2019.5





VAUXHALL

British Brand since 1903

ASTRA RANGE HIGHLIGHTS



DESIGN	OTR from £18,900
<i>Standard features include:</i>	
Exterior convenience / styling:	
<ul style="list-style-type: none"> • 16-inch alloy wheels • Dark-tinted rear windows • Automatic lighting control • Electrically operated front / rear windows • Remote control central locking • Electrically adjustable / heated door mirrors • Front fog lights • Black roof rails (Sports Tourer) 	
Interior convenience / styling:	
<ul style="list-style-type: none"> • Air conditioning • Multi-function trip computer • Cruise control with speed limiter • Steering wheel audio / phone / cruise controls • Steering column adjustable for reach / rake 	
Infotainment:	
<ul style="list-style-type: none"> • IntelliLink audio system <ul style="list-style-type: none"> – 7-inch colour touchscreen – AM/FM/DAB digital radio – Bluetooth® audio streaming – Bluetooth® mobile phone portal – Apple CarPlay™ / Android Auto™ – USB audio connection • Four speakers (front) 	
Safety / security:	
<ul style="list-style-type: none"> • Electronic Stability Programme (ESP) • Anti-lock Braking System (ABS) • Six airbags • Hill start assist • ISOFIX child seat mounting points on outer rear seats • Seatbelt pretensioners for front / outer rear seats • Tyre pressure monitoring system • Door-to-door illumination • LED daytime running lights • Electronic engine deadlock immobiliser 	
	

TECH LINE NAV	OTR from £19,600
<i>Features over Design:</i>	
Interior convenience / styling:	
<ul style="list-style-type: none"> • Leather-covered steering wheel • Adjustable front armrest 	
Infotainment:	
<ul style="list-style-type: none"> • Navi R4.0 IntelliLink system <ul style="list-style-type: none"> – Fully integrated European sat nav system 	
	

SRI	OTR from £21,760
<i>Features over Design:</i>	
Exterior convenience / styling:	
<ul style="list-style-type: none"> • 17-inch five twin-spoke alloy wheels • Chrome-effect upper window trim • Rain-sensitive windscreen wipers • Automatic lighting control with tunnel detection • Automatic anti-dazzle rear-view mirror • Silver-effect roof rails (Sports Tourer) 	
Interior convenience / styling:	
<ul style="list-style-type: none"> • Leather-covered steering wheel • Sports style front seats • Driver's ergonomic active seat • Front centre armrest • Storage pockets on front seat backs • Sport switch 	
Infotainment:	
<ul style="list-style-type: none"> • Six speakers (four front, two rear) 	
Safety / security:	
<ul style="list-style-type: none"> • Driving Assistance Pack One featuring intelligent forward camera system • Remote control alarm system (Optional at extra cost on 1.0 Turbo (105PS) models) 	
SRI Nav models additionally feature	
<ul style="list-style-type: none"> • Navi 900 IntelliLink system <ul style="list-style-type: none"> – Fully integrated European sat nav system – 8-inch colour touchscreen 	
Please note: Astra SRI does not feature dark-tinted rear windows.	
	

ASTRA RANGE HIGHLIGHTS



SRi VX-LINE OTR from £23,270

Features over Design:

Exterior convenience / styling:

- 18-inch five twin-spoke alloy wheels
- Chrome-effect upper window trim
- Sports-style front and rear bumper / side sills
- Rain-sensitive windscreen wipers
- Automatic lighting control with tunnel detection
- Automatic anti-dazzle rear-view mirror

Interior convenience / styling:

- Leather-covered steering wheel
- Sports style front seats
- Driver's ergonomic active seat
- Front centre armrest
- Storage pockets on front seat backs
- Sport switch

Infotainment:

- Six speakers (four front, two rear)

Safety / security:

- Driving Assistance Pack One featuring intelligent forward camera system
- Remote control alarm system

SRi VX-LINE Nav models additionally feature

- Navi 900 IntelliLink system
 - Fully integrated European sat nav system
 - 8-inch colour touchscreen

Please note: Astra SRi VX-Line does not feature front fog lights or dark-tinted rear windows.



ELITE NAV OTR from £22,920

Features over Design:

Exterior convenience / styling:

- 17-inch multi-spoke alloy wheels
- Chrome-effect upper window trim
- Rain-sensitive windscreen wipers
- Automatic lighting control with tunnel detection
- Automatic anti-dazzle rear-view mirror
- Electrically folding door mirrors
- Silver-effect roof rails (Sports Tourer)

Interior convenience / styling:

- Leather seat trim
- Electronic dual-zone climate control
- Heated leather-covered steering wheel
- Heated front / outer rear seats
- Sports style front seats
- Four-way electrical lumbar adjustment
- Front centre armrest
- Centre rear armrest
- Storage pockets on front seat backs
- Electric parking brake
- Two rear USB charging points
- Front door sill covers

Infotainment:

- Navi 900 IntelliLink system
 - Fully integrated European sat nav system
 - 8-inch colour touchscreen
- Six speakers (four front, two rear)

Safety / security:

- Remote control alarm system

Please note: Astra Elite Nav does not feature dark-tinted rear windows.

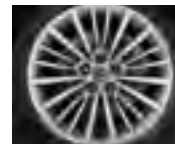

ULTIMATE OTR from £26,030

Features over Design:

Exterior convenience / styling:

- 18-inch bi-colour alloy wheels
- IntelliLux LED Matrix headlights
- Parking Pack
 - Front and rear parking distance sensors
 - Advance park assist
 - Side blind spot alert
 - Rear-view camera
- Chrome-effect upper window trim
- Rain-sensitive windscreen wipers
- Automatic lighting control with tunnel detection
- Automatic anti-dazzle rear-view mirror
- Electrically folding door mirrors

Interior convenience / styling:

- Perforated leather seat trim
- Electronic dual-zone climate control
- Heated leather-covered steering wheel
- Heated front / outer rear seats
- Driver's and front passenger's ergonomic active seats
- Four-way electrical lumbar adjustment
- Front centre armrest
- Centre rear armrest
- Storage pockets on front seat backs
- Electric parking brake
- Two rear USB charging points
- Front door sill covers

Infotainment:

- Navi 900 IntelliLink system
 - Fully integrated European sat nav system
 - 8-inch colour touchscreen
- Six speakers (four front, two rear)

Safety / security:







- Driving Assistance Pack One featuring intelligent forward camera system
- Remote control alarm system



ASTRA DESIGN

		Hatchback		Sports Tourer	
		OTR RRP	CO ₂ (g/km)	OTR RRP	CO ₂ (g/km)
DESIGN – ON-THE-ROAD PRICES					
Petrol	1.0i Turbo (105PS) S/S ecoTEC	£18,900	107	£20,350	107
	1.4i Turbo (125PS)	£18,960	133	£20,410	136
	1.4i Turbo (150PS) S/S auto	£20,570	130	–	–
Diesel	1.6CDTi (110PS) S/S ecoTEC BlueInjection	£20,370	107	£21,860	112
	1.6CDTi (136PS) S/S BlueInjection	£21,100	116	£22,550	118

Please note: On-the-road recommended retail prices (RRP) include VAT at 20%, number plates and delivery to Retailer of £700.00 (inc. £116.67 VAT), 12 months' Vehicle Excise Duty and new vehicle first registration fee of £55.00. Excludes fuel and insurance. S/S = Start/Stop.

KEY OPTIONS		Total inc. VAT
 Looking good:	Brilliant paint	£285
	Metallic paint	£575
	Premium paint	£655
	17-inch 10-spoke alloy wheels	£480
 Easier parking:	Front and rear parking distance sensors	£480
 Sitting comfortably:	Driver's ergonomic active seat	£260
	Winter Pack <i>Heated leather-covered steering wheel / heated front seats</i>	£355
 Fresh air:	Power tilt and slide sunroof	£550
 Driving assistance:	Driving Assistance Pack One <i>Forward collision alert with automatic city emergency braking / traffic sign recognition / following distance indicator / lane departure warning with lane assist</i>	£815
	 Practicality:	Steel emergency spare wheel (in lieu of emergency tyre inflation kit)
Full-size 16-inch steel spare wheel (in lieu of emergency tyre inflation kit) (Sports Tourer only)		£110
Remote control ultrasonic security alarm system		£260

For details of these and other options please see Features / Options pages.



FEATURES

Infotainment:

- IntelliLink audio system
 - 7-inch colour touchscreen
 - AM/FM/DAB digital radio
 - Bluetooth® audio streaming
 - Bluetooth® mobile phone portal
 - Apple CarPlay™ / Android Auto™
 - USB audio connection
- Four speakers (front)

Interior convenience / styling:

- Air conditioning
- Multi-function trip computer
- Cruise control with speed limiter
- Steering wheel audio / phone / cruise controls
- Steering column adjustable for reach / rake





Exterior convenience / styling:

- 16-inch alloy wheels
- Automatic lighting control
- Electrically operated front / rear windows
- Remote control central locking
- Electrically adjustable / heated door mirrors
- Black roof rails (Sports Tourer)
- Front fog lights
- Dark-tinted rear windows

Safety / security:

- Electronic Stability Programme (ESP)
- Anti-lock Braking System (ABS)
- Six airbags
- Hill start assist
- ISOFIX child seat mounting points on outer rear seats
- Tyre pressure monitoring system
- Door-to-door illumination
- LED daytime running lights
- Electronic engine deadlock immobiliser

COMPANY CAR INFORMATION

-  P11D price starting at £18,700
-  From 22% tax band*
-  From £69 monthly BiK tax*
-  CO₂ emissions from 107g/km







Please see www.vauxhall.co.uk/fleet for details.

* = 2018/19 tax year.

ASTRA TECH LINE NAV

		Hatchback		Sports Tourer	
		OTR RRP	CO ₂ (g/km)	OTR RRP	CO ₂ (g/km)
TECH LINE NAV – ON-THE-ROAD PRICES					
Petrol	1.0i Turbo (105PS) S/S ecoTEC	£19,600	107	£21,050	107
	1.4i Turbo (125PS)	£19,660	133	£21,110	136
	1.4i Turbo (150PS) S/S auto	£21,270	130	–	–
Diesel	1.6CDTi (110PS) S/S ecoTEC BlueInjection	£21,070	107	£22,560	112
	1.6CDTi (136PS) S/S BlueInjection	£21,800	116	£23,250	118
	1.6CDTi (136PS) S/S auto BlueInjection	£23,120	122	–	–

Please note: On-the-road recommended retail prices (RRP) include VAT at 20%, number plates and delivery to Retailer of £700.00 (inc. £116.67 VAT), 12 months' Vehicle Excise Duty and new vehicle first registration fee of £55.00. Excludes fuel and insurance. S/S = Start/Stop.

KEY OPTIONS		Total inc. VAT
 Looking good:	Brilliant paint	£285
	Metallic paint	£575
	Premium paint	£655
	17-inch 10-spoke alloy wheels	£480
 Easier parking:	Front and rear parking distance sensors	£480
 Sitting comfortably:	Driver's ergonomic active seat	£260
	Winter Pack <i>Heated leather-covered steering wheel / heated front seats</i>	£355
 Fresh air:	Power tilt and slide sunroof	£550
 Driving assistance:	Driving Assistance Pack One <i>Forward collision alert with automatic city emergency braking / traffic sign recognition / following distance indicator / lane departure warning with lane assist</i>	£815
	 Practicality:	Steel emergency spare wheel (in lieu of emergency tyre inflation kit)
Full-size 16-inch steel spare wheel (in lieu of emergency tyre inflation kit) (Sports Tourer only)		£110
Remote control ultrasonic security alarm system		£260
CD drive		£135

For details of these and other options please see Features / Options pages.



FEATURES

Infotainment:

- Navi R4.0 IntelliLink system
 - Fully integrated European sat nav system
 - 7-inch colour touchscreen
 - AM/FM/DAB digital radio
 - Bluetooth® audio streaming
 - Bluetooth® mobile phone portal
 - Apple CarPlay™ / Android Auto™
 - USB audio connection
- Four speakers

Interior convenience / styling:

- Air conditioning
- Multi-function trip computer
- Cruise control with speed limiter
- Leather-covered steering wheel
- Front centre armrest
- Steering wheel audio / phone / cruise controls
- Steering column adjustable for reach / rake



Exterior convenience / styling:

- 16-inch alloy wheels
- Automatic lighting control
- Electrically operated front / rear windows
- Remote control central locking
- Electrically adjustable / heated door mirrors
- Black roof rails (Sports Tourer)
- Front fog lights
- Dark-tinted rear windows

Safety / security:

- Electronic Stability Programme (ESP)
- Anti-lock Braking System (ABS)
- Six airbags
- Hill start assist
- ISOFIX child seat mounting points on outer rear seats
- Tyre pressure monitoring system
- Door-to-door illumination
- LED daytime running lights
- Electronic engine deadlock immobiliser

COMPANY CAR INFORMATION

-  P11D price starting at £19,400
-  From 22% tax band*
-  From £72 monthly BiK tax*
-  CO₂ emissions from 107g/km

Please see www.vauxhall.co.uk/fleet for details.

* = 2018/19 tax year.

ASTRA SRi

		Hatchback		Sports Tourer	
		OTR RRP	CO ₂ (g/km)	OTR RRP	CO ₂ (g/km)
Sri – ON-THE-ROAD PRICES					
<i>Petrol</i>	1.0i Turbo (105PS) S/S ecoTEC	£21,760	110	–	–
	1.4i Turbo (150PS)	£22,070	136	£23,520	139
	1.4i Turbo (150PS) S/S auto	£23,470	134	£24,920	134
	1.6i Turbo (200PS) S/S	£23,470	147	£24,920	147
<i>Diesel</i>	1.6CDTi (110PS) S/S ecoTEC BlueInjection	£23,230	110	£24,720	116
	1.6CDTi (136PS) S/S BlueInjection	£23,960	118	£25,410	121
	1.6CDTi (136PS) S/S auto BlueInjection	£25,280	126	£26,730	130

		Hatchback		Sports Tourer	
		OTR RRP	CO ₂ (g/km)	OTR RRP	CO ₂ (g/km)
Sri NAV – ON-THE-ROAD PRICES					
<i>Petrol</i>	1.0i Turbo (105PS) S/S ecoTEC	£22,460	110	–	–
	1.4i Turbo (150PS)	£22,770	136	£24,220	139
	1.4i Turbo (150PS) S/S auto	£24,170	134	£25,620	134
	1.6i Turbo (200PS) S/S	£24,170	147	£25,620	147
<i>Diesel</i>	1.6CDTi (110PS) S/S ecoTEC BlueInjection	£23,930	110	£25,420	116
	1.6CDTi (136PS) S/S BlueInjection	£24,660	118	£26,110	121
	1.6CDTi (136PS) S/S auto BlueInjection	£25,980	126	£27,430	130

Please note: On-the-road recommended retail prices (RRP) include VAT at 20%, number plates and delivery to Retailer of £700.00 (inc. £116.67 VAT), 12 months' Vehicle Excise Duty and new vehicle first registration fee of £55.00. Excludes fuel and insurance. S/S = Start/Stop.

KEY OPTIONS		Total inc. VAT
 Looking good:	Brilliant paint	£285
	Metallic paint	£575
	Premium paint	£655
	18-inch bi-colour alloy wheels	£480
	18-inch five twin-spoke alloy wheels	£480
 Easier parking:	Parking Pack <i>Front and rear parking distance sensors / advance park assist / side blind spot alert / rear-view camera</i>	£750
	Front and rear parking distance sensors	£480
 Sitting comfortably:	Winter Pack <i>Heated leather-covered steering wheel / heated front seats</i>	£355
 Fresh air:	Power tilt and slide sunroof	£550
	Electronic climate control	£425
 Driving assistance:	IntelliLux LED Matrix headlights	£1250
	LED tail lights (standard with IntelliLux LED Matrix headlights)	£205

For details of these and other options please see Features / Options pages.



FEATURES

Infotainment:

- IntelliLink audio system
 - 7-inch colour touchscreen
 - AM/FM/DAB digital radio
 - Bluetooth® audio streaming
 - Bluetooth® mobile phone portal
 - Apple CarPlay™ / Android Auto™
 - USB audio connection
- Six speakers (four front, two rear)

Interior convenience / styling:

- Air conditioning
- Multi-function trip computer
- Sports style front seats
- Driver's ergonomic active seat
- Front centre armrest
- Storage pockets on front seat backs
- Cruise control with speed limiter
- Steering wheel audio / phone / cruise controls
- Sport switch
- Steering column adjustable for reach / rake

Exterior convenience / styling:

- 17-inch five twin-spoke alloy wheels
- Chrome-effect upper window trim
- Rain-sensitive windscreen wipers
- Automatic lighting control with tunnel detection
- Automatic anti-dazzle rear-view mirror
- Front fog lights
- Remote control central locking
- Electrically operated front / rear windows
- Electrically adjustable/heated door mirrors
- Silver-effect roof rails (Sports Tourer)





Safety / security:

- Driving Assistance Pack One featuring intelligent forward camera system
- Electronic Stability Programme (ESP)
- Anti-lock Braking System (ABS)
- Six airbags
- Hill start assist
- ISOFIX child seat mounting points on outer rear seats
- Tyre pressure monitoring system
- LED daytime running lights
- Remote control alarm system (optional at extra cost on 1.0i Turbo (105PS) models)
- Electronic engine deadlock immobiliser

Sri Nav models additional feature:

- Navi 900 IntelliLink system
 - Fully integrated European sat nav system
 - 8-inch colour touchscreen

COMPANY CAR INFORMATION

-  P11D price starting at £21,560
-  From 23% tax band*
-  From £83 monthly BiK tax*
-  CO₂ emissions from 110g/km

Please see www.vauxhall.co.uk/fleet for details.

* = 2018/19 tax year.

ASTRA SRI VX-LINE

	Hatchback		Sports Tourer	
	OTR RRP	CO ₂ (g/km)	OTR RRP	CO ₂ (g/km)





SRI VX-LINE – ON-THE-ROAD PRICES

<i>Petrol</i>	1.4i Turbo (150PS)	£23,270	138	–	–
<i>Diesel</i>	1.6CDTi (136PS) S/S BlueInjection	£25,160	121	–	–

SRI VX-LINE NAV – ON-THE-ROAD PRICES

<i>Petrol</i>	1.4i Turbo (150PS)	£23,970	138	–	–
	1.6i Turbo (200PS) S/S	£25,680	151	–	–
<i>Diesel</i>	1.6CDTi (136PS) S/S BlueInjection	£25,860	121	–	–
	1.6CDTi BiTurbo (150PS) S/S BlueInjection	£26,780	133	–	–

Please note: On-the-road recommended retail prices (RRP) include VAT at 20%, number plates and delivery to Retailer of £700.00 (inc. £116.67 VAT), 12 months' Vehicle Excise Duty and new vehicle first registration fee of £55.00. Excludes fuel and insurance. S/S = Start/Stop.

KEY OPTIONS		Total inc. VAT
	Looking good:	
	Brilliant paint	£285
	Metallic paint	£575
	Premium paint	£655
	Easier parking:	
	Parking Pack	
	Front and rear parking distance sensors / advance park assist / side blind spot alert / rear-view camera	£750
	Front and rear parking distance sensors	£480
	Sitting comfortably:	
	Winter Pack	
	Heated leather-covered steering wheel / heated front seats	£355
	Fresh air:	
	Power tilt and slide sunroof	£550
	Electronic climate control	£425
	Driving assistance:	
	IntelliLux LED Matrix headlights	£1250
	LED tail lights (standard with IntelliLux LED Matrix headlights)	£205

For details of these and other options please see Features / Options pages.



FEATURES

Infotainment:

- IntelliLink audio system
 - 7-inch colour touchscreen
 - AM/FM/DAB digital radio
 - Bluetooth® audio streaming
 - Bluetooth® mobile phone portal
 - Apple CarPlay™ / Android Auto™
 - USB audio connection
- Six speakers (four front, two rear)

Interior convenience / styling:

- Air conditioning
- Multi-function trip computer
- Sports style front seats
- Driver's ergonomic active seat
- Front centre armrest
- Storage pockets on front seat backs
- Cruise control with speed limiter
- Steering wheel audio / phone / cruise controls
- Sport switch
- Steering column adjustable for reach / rake

Exterior convenience / styling:

- 18-inch five twin-spoke alloy wheels
- Body-colour front lower spoiler / side sills / rear lower skirt
- Chrome-effect upper window trim
- Rain-sensitive windscreen wipers
- Automatic lighting control with tunnel detection
- Automatic anti-dazzle rear-view mirror
- Remote control central locking
- Electrically operated front and rear windows
- Electrically adjustable/heated door mirrors



Safety / security:

- Driving Assistance Pack One featuring intelligent forward camera system
- Electronic Stability Programme (ESP)
- Anti-lock Braking System (ABS)
- Six airbags
- Hill start assist
- ISOFIX child seat mounting points on outer rear seats
- Tyre pressure monitoring system
- LED daytime running lights
- Remote control alarm system
- Electronic engine deadlock immobiliser

SRI VX-Line Nav models additional feature:

- Navi 900 IntelliLink system
 - Fully integrated European sat nav system
 - 8-inch colour touchscreen

COMPANY CAR INFORMATION

-  P11D price starting at £23,010
-  From 28% tax band**
-  From £108 monthly BiK tax**
-  CO₂ emissions from 121g/km





Please see www.vauxhall.co.uk/fleet for details.

** = 2018/19 tax year.

ASTRA ELITE NAV

		Hatchback		Sports Tourer	
		OTR RRP	CO ₂ (g/km)	OTR RRP	CO ₂ (g/km)
ELITE NAV – ON-THE-ROAD PRICES					
<i>Petrol</i>	1.0i Turbo (105PS) S/S ecoTEC	£22,920	110	–	–
	1.4i Turbo (150PS)	£23,230	136	£24,680	139
	1.4i Turbo (150PS) S/S auto	£24,630	134	£26,080	134
	1.6i Turbo (200PS) S/S	£24,630	147	£26,080	147
<i>Diesel</i>	1.6CDTi (110PS) S/S ecoTEC BlueInjection	£24,390	110	£25,880	116
	1.6CDTi (136PS) S/S BlueInjection	£25,120	118	£26,570	121
	1.6CDTi (136PS) S/S auto BlueInjection	£26,440	126	£27,890	130
	1.6CDTi BiTurbo (150PS) S/S BlueInjection	£25,730	130	£27,490	134

Please note: On-the-road recommended retail prices (RRP) include VAT at 20%, number plates and delivery to Retailer of £700.00 (inc. £116.67 VAT), 12 months' Vehicle Excise Duty and new vehicle first registration fee of £55.00. Excludes fuel and insurance. S/S = Start/Stop.

KEY OPTIONS		Total inc. VAT
 Looking good:	Brilliant paint	£285
	Metallic paint	£575
	Premium paint	£655
	18-inch bi-colour alloy wheels	£480
 Easier parking:	Parking Pack <i>Front and rear parking distance sensors / advance park assist / side blind spot alert / rear-view camera</i>	£750
 Sitting comfortably:	Driver's and front passenger's ergonomic active seats	£205
 Fresh air:	Power tilt and slide sunroof	£550
 Driving assistance:	Driving Assistance Pack One <i>Forward collision alert with automatic city emergency braking / traffic sign recognition / following distance indicator / lane departure warning with lane assist</i>	£575
	IntelliLux LED Matrix headlights	£1825

For details of these and other options please see Features / Options pages.



FEATURES

Infotainment:

- Navi 900 IntelliLink system
 - Fully integrated European sat nav system
 - 8-inch colour touchscreen
 - AM/FM/DAB digital radio
 - Bluetooth® audio streaming
 - Bluetooth® mobile phone portal
 - Apple CarPlay™ / Android Auto™
 - USB audio connection
- Six speakers (four front, two rear)

Interior convenience / styling:

- Leather seat trim
- Electronic dual-zone climate control
- Heated leather-covered steering wheel
- Heated front / outer rear seats
- Sports style front seats
- Four-way electrical lumbar adjustment
- Adjustable front armrest
- Centre rear armrest
- Multi-function trip computer
- Steering wheel audio / phone / cruise controls
- Electric parking brake
- Cruise control with speed limiter
- Two rear USB charging points

Exterior convenience / styling:

- 17-inch multi-spoke alloy wheels
- Chrome-effect upper window trim
- Rain-sensitive windscreen wipers
- Automatic lighting control with tunnel detection
- Automatic anti-dazzle rear-view mirror
- Front fog lights
- Remote control central locking
- Electrically operated front / rear windows
- Electrically adjustable / heated / folding door mirrors
- Silver-effect roof rails (Sports Tourer)

Safety / security:

- Electronic Stability Programme (ESP)
- Anti-lock Braking System (ABS)
- Six airbags
- Remote control alarm system
- Hill start assist
- ISOFIX child seat mounting points on outer rear seats
- Electronic engine deadlock immobiliser
- Tyre pressure monitoring system
- Door-to-door illumination
- LED daytime running lights

COMPANY CAR INFORMATION

-  P11D price starting at £22,720
-  From 23% tax band**
-  From £88 monthly BiK tax**
-  CO₂ emissions from 110g/km





Please see www.vauxhall.co.uk/fleet for details.

** = 2018/19 tax year.

ASTRA ULTIMATE

	Hatchback		Sports Tourer		
	OTR RRP	CO ₂ (g/km)	OTR RRP	CO ₂ (g/km)	
ULTIMATE – ON-THE-ROAD PRICES					
<i>Petrol</i>	1.4i Turbo (150PS)	£26,030	138	–	–
	1.4i Turbo (150PS) S/S auto	£27,430	139	–	–
	1.6i Turbo (200PS) S/S	£27,740	151	–	–
<i>Diesel</i>	1.6CDTi BiTurbo (150PS) S/S BlueInjection	£28,840	133	–	–

Please note: On-the-road recommended retail prices (RRP) include VAT at 20%, number plates and delivery to Retailer of £700.00 (inc. £116.67 VAT), 12 months' Vehicle Excise Duty and new vehicle first registration fee of £55.00. Excludes fuel and insurance. S/S = Start/Stop.

KEY OPTIONS		Total inc. VAT
 Looking good:	Brilliant paint	£285
	Metallic paint	£575
	Premium paint	£655
	VX-Line Styling Pack <i>Sports-style front and rear bumpers / side sills</i>	£995
 Sitting comfortably:	Driver's Ergonomic Active Seat with Wellness Functions	£715
 Fresh air:	Power tilt and slide sunroof	£550
 Practicality:	CD drive	£135
	Keyless entry and start	£405

For details of these and other options please see Features / Options pages.



FEATURES

Infotainment:

- Navi 900 IntelliLink system
 - Fully integrated European sat nav system
 - 8-inch colour touchscreen
 - AM/FM/DAB digital radio
 - Bluetooth® audio streaming
 - Bluetooth® mobile phone portal
 - Apple CarPlay™ / Android Auto™
 - USB audio connection
- Six speakers (four front, two rear)

Interior convenience / styling:

- Perforated leather seat trim
- Electronic dual-zone climate control
- Heated leather-covered steering wheel
- Heated front / outer rear seats
- Sports style front seats
- Driver's and front passenger's ergonomic active seats
- Four-way electrical lumbar adjustment
- Adjustable front armrest
- Centre rear armrest
- Multi-function trip computer
- Steering wheel audio / phone / cruise controls
- Electric parking brake
- Cruise control with speed limiter
- Two rear USB charging points





Exterior convenience / styling:

- 18-inch bi-colour alloy wheels
- Chrome-effect upper window trim
- Rain-sensitive windscreen wipers
- Automatic lighting control with tunnel detection
- Automatic anti-dazzle rear-view mirror
- IntelliLux LED Matrix headlights
- Front fog lights
- Parking Pack
 - Front and rear parking distance sensors
 - Advance park assist
 - Side blind spot alert
 - Rear-view camera
- Remote control central locking
- Electrically operated front / rear windows
- Electrically adjustable / heated / folding door mirrors
- Dark-tinted rear windows

Safety / security:

- Driving Assistance Pack One featuring intelligent forward camera system
- Electronic Stability Programme (ESP)
- Anti-lock Braking System (ABS)
- Six airbags
- Remote control alarm system
- Hill start assist
- ISOFIX child seat mounting points on outer rear seats
- Electronic engine deadlock immobiliser
- Tyre pressure monitoring system
- Door-to-door illumination
- LED daytime running lights
- LED tail lights

COMPANY CAR INFORMATION

-  **P11D price starting at £25,770**
-  **From 28% tax band****
-  **From £121 monthly BiK tax****
-  **CO₂ emissions from 133g/km**

Please see www.vauxhall.co.uk/fleet for details.

** = 2018/19 tax year.

ASTRA PRICES

Model 5-door hatchback	Price (£)	VAT (£)	Total (£)	On-the-road RRP (£)	CO ₂ (g/km)	Model 5-door hatchback	Price (£)	VAT (£)	Total (£)	On-the-road RRP (£)	CO ₂ (g/km)
DESIGN						SRI VX-LINE					
1.0i Turbo (105PS) S/S ecoTEC	15000.00	3000.00	18000.00	18900.00	107	1.4i Turbo (150PS)	18591.67	3718.33	22310.00	23270.00	138
1.4i Turbo (125PS)	15000.00	3000.00	18000.00	18960.00	133	<i>Diesel</i>					
1.4i Turbo (150PS) S/S auto	16375.00	3275.00	19650.00	20570.00	130	1.6CDTi (136PS) S/S BlueInjection*	20166.67	4033.33	24200.00	25160.00	121
<i>Diesel</i>						SRI VX-LINE NAV					
1.6CDTi (110PS) S/S ecoTEC BlueInjection*	16208.33	3241.67	19450.00	20370.00	107	1.4i Turbo (150PS)	19175.00	3835.00	23010.00	23970.00	138
1.6CDTi (136PS) S/S BlueInjection*	16783.33	3356.67	20140.00	21100.00	116	1.6i Turbo (200PS) S/S	20341.67	4068.33	24410.00	25680.00	151
TECH LINE NAV						<i>Diesel</i>					
1.0i Turbo (105PS) S/S ecoTEC	15583.33	3116.67	18700.00	19600.00	107	1.6CDTi (136PS) S/S BlueInjection*	20750.00	4150.00	24900.00	25860.00	121
1.4i Turbo (125PS)	15583.33	3116.67	18700.00	19660.00	133	1.6CDTi BiTurbo (150PS) S/S BlueInjection*	21258.33	4251.67	25510.00	26780.00	133
1.4i Turbo (150PS) S/S auto	16958.33	3391.67	20350.00	21270.00	130	ELITE NAV					
<i>Diesel</i>						1.0i Turbo (105PS) S/S ecoTEC	18350.00	3670.00	22020.00	22920.00	110
1.6CDTi (110PS) S/S ecoTEC BlueInjection*	16791.67	3358.33	20150.00	21070.00	107	1.4i Turbo (150PS)	18558.33	3711.67	22270.00	23230.00	136
1.6CDTi (136PS) S/S BlueInjection*	17366.67	3473.33	20840.00	21800.00	116	1.4i Turbo (150PS) S/S auto	19725.00	3945.00	23670.00	24630.00	134
1.6CDTi (136PS) S/S auto BlueInjection*	18466.67	3693.33	22160.00	23120.00	122	1.6i Turbo (200PS) S/S	19725.00	3945.00	23670.00	24630.00	147
SRI						<i>Diesel</i>					
1.0i Turbo (105PS) S/S ecoTEC	17383.33	3476.67	20860.00	21760.00	110	1.6CDTi (110PS) S/S ecoTEC BlueInjection*	19558.33	3911.67	23470.00	24390.00	110
1.4i Turbo (150PS)	17591.67	3518.33	21110.00	22070.00	136	1.6CDTi (136PS) S/S BlueInjection*	20133.33	4026.67	24160.00	25120.00	118
1.4i Turbo (150PS) S/S auto	18758.33	3751.67	22510.00	23470.00	134	1.6CDTi (136PS) S/S auto BlueInjection*	21233.33	4246.67	25480.00	26440.00	126
1.6i Turbo (200PS) S/S	18758.33	3751.67	22510.00	23470.00	147	1.6CDTi BiTurbo (150PS) S/S BlueInjection*	20641.67	4128.33	24770.00	25730.00	130
<i>Diesel</i>						ULTIMATE					
1.6CDTi (110PS) S/S ecoTEC BlueInjection*	18591.67	3718.33	22310.00	23230.00	110	1.4i Turbo (150PS)	20891.67	4178.33	25070.00	26030.00	138
1.6CDTi (136PS) S/S BlueInjection*	19166.67	3833.33	23000.00	23960.00	118	1.4i Turbo (150PS) S/S auto	22058.33	4411.67	26470.00	27430.00	139
1.6CDTi (136PS) S/S auto BlueInjection*	20266.67	4053.33	24320.00	25280.00	126	1.6i Turbo (200PS) S/S	22058.33	4411.67	26470.00	27740.00	151
SRI NAV						<i>Diesel</i>					
1.0i Turbo (105PS) S/S ecoTEC	17966.67	3593.33	21560.00	22460.00	110	1.6CDTi BiTurbo (150PS) S/S BlueInjection*	22975.00	4595.00	27570.00	28840.00	133
1.4i Turbo (150PS)	18175.00	3635.00	21810.00	22770.00	136	Please note: On-the-road recommended retail prices (RRP) include number plates and delivery to Retailer of £700.00 (inc. £116.67 VAT), 12 months' Vehicle Excise Duty and new vehicle first registration fee of £55.00. Excludes fuel and insurance.					
1.4i Turbo (150PS) S/S auto	19341.67	3868.33	23210.00	24170.00	134	S/S = Start/Stop.					
1.6i Turbo (200PS) S/S	19341.67	3868.33	23210.00	24170.00	147	* = Please note: Vehicles with BlueInjection technology will need regular AdBlue® top-ups also between servicing requirements.					
<i>Diesel</i>						An indicator integrated into the on-board computer will warn you when you need to top up. More information under www.vauxhall.co.uk/adblue . In accordance with regulations R (EC) No. 715/2007 and R (EC) No. 692/2008 (in the versions respectively applicable).					
1.6CDTi (110PS) S/S ecoTEC BlueInjection*	19175.00	3835.00	23010.00	23930.00	110						
1.6CDTi (136PS) S/S BlueInjection*	19750.00	3950.00	23700.00	24660.00	118						
1.6CDTi (136PS) S/S auto BlueInjection*	20850.00	4170.00	25020.00	25980.00	126						

ASTRA PRICES

Model Sports Tourer	Price (£)	VAT (£)	Total (£)	On-the-road RRP (£)	CO ₂ (g/km)	Model Sports Tourer	Price (£)	VAT (£)	Total (£)	On-the-road RRP (£)	CO ₂ (g/km)
DESIGN						SRI NAV					
1.0i Turbo (105PS) S/S ecoTEC	16208.33	3241.67	19450.00	20350.00	107	1.4i Turbo (150PS)	19383.33	3876.67	23260.00	24220.00	139
1.4i Turbo (125PS)	16208.33	3241.67	19450.00	20410.00	136	1.4i Turbo (150PS) S/S auto	20550.00	4110.00	24660.00	25620.00	134
<i>Diesel</i>						1.6i Turbo (200PS) S/S	20550.00	4110.00	24660.00	25620.00	147
1.6CDTi (110PS) S/S ecoTEC BlueInjection*	17416.67	3483.33	20900.00	21860.00	112	<i>Diesel</i>					
1.6CDTi (136PS) S/S BlueInjection*	17991.67	3598.33	21590.00	22550.00	118	1.6CDTi (110PS) S/S ecoTEC BlueInjection*	20383.33	4076.67	24460.00	25420.00	116
TECH LINE NAV						1.6CDTi (136PS) S/S BlueInjection*	20958.33	4191.67	25150.00	26110.00	121
1.0i Turbo (105PS) S/S ecoTEC	16791.67	3358.33	20150.00	21050.00	107	1.6CDTi (136PS) S/S auto BlueInjection*	22058.33	4411.67	26470.00	27430.00	130
1.4i Turbo (125PS)	16791.67	3358.33	20150.00	21110.00	136	ELITE NAV					
<i>Diesel</i>						1.4i Turbo (150PS)	19766.67	3953.33	23720.00	24680.00	139
1.6CDTi (110PS) S/S ecoTEC BlueInjection*	18000.00	3600.00	21600.00	22560.00	112	1.4i Turbo (150PS) S/S auto	20933.33	4186.67	25120.00	26080.00	134
1.6CDTi (136PS) S/S BlueInjection*	18575.00	3715.00	22290.00	23250.00	118	1.6i Turbo (200PS) S/S	20933.33	4186.67	25120.00	26080.00	147
SRI						<i>Diesel</i>					
1.4i Turbo (150PS)	18800.00	3760.00	22560.00	23520.00	139	1.6CDTi (110PS) S/S ecoTEC BlueInjection*	20766.67	4153.33	24920.00	25880.00	116
1.4i Turbo (150PS) S/S auto	19966.67	3993.33	23960.00	24920.00	134	1.6CDTi (136PS) S/S BlueInjection*	21341.67	4268.33	25610.00	26570.00	121
1.6i Turbo (200PS) S/S	19966.67	3993.33	23960.00	24920.00	147	1.6CDTi (136PS) S/S auto BlueInjection*	22441.67	4488.33	26930.00	27890.00	130
<i>Diesel</i>						1.6CDTi BiTurbo (150PS) S/S BlueInjection*	21850.00	4370.00	26220.00	27490.00	134
1.6CDTi (110PS) S/S ecoTEC BlueInjection*	19800.00	3960.00	23760.00	24720.00	116	<p>Please note: On-the-road recommended retail prices (RRP) include number plates and delivery to Retailer of £700.00 (inc. £116.67 VAT), 12 months' Vehicle Excise Duty and new vehicle first registration fee of £55.00. Excludes fuel and insurance.</p> <p>S/S = Start/Stop.</p> <p>* = Please note: Vehicles with BlueInjection technology will need regular AdBlue® top-ups also between servicing requirements. An indicator integrated into the on-board computer will warn you when you need to top up. More information under www.vauxhall.co.uk/adblue. In accordance with regulations R (EC) No. 715/2007 and R (EC) No. 692/2008 (in the versions respectively applicable).</p>					
1.6CDTi (136PS) S/S BlueInjection*	20375.00	4075.00	24450.00	25410.00	121						
1.6CDTi (136PS) S/S auto BlueInjection*	21475.00	4295.00	25770.00	26730.00	130						

ASTRA FEATURES / OPTIONS

SAFETY

Driver / passenger airbags

- Driver's airbag • Front passenger's airbag • Two front seat side-impact airbags
- Full-size curtain airbags for driver and front and outer rear seat passengers

Seating

- Height-adjustable front seat head restraints • Three height adjustable rear seat head restraints
- Anti-submarining ramps in all seats – Prevents occupants sliding underneath the lap belt during a collision.

Seatbelts

- Height adjustable front inertia-reel lap and diagonal seatbelts • Three inertia-reel lap and diagonal rear seatbelts • Front seatbelts with crash locking tongues • Outer rear seatbelt pretensioner system – Pretensioners tighten the seatbelt in the event of an accident limiting forward movement. • Front and outer rear seatbelt force limiters – Reduces potential upper body injuries during a frontal impact. • Front and rear 'seatbelt unfastened' audible warning and warning light

Child safety

- Deactivation switch for front passenger's airbag – Permits the safe use of a child seat in the front passenger seat. • ISOFIX child seat mountings incorporating top tether anchor points located on outer rear seats (does not include child seat) – Allows ISOFIX child safety seats to be securely fixed into the car. The ISOFIX mounting system reduces forward movement in an accident and makes the child seat easier to install. • Child-proof locks on rear doors

Driver / passenger safety

- Energy-absorbing steering column • Pedal release system – Reduces potential injury to the driver's legs and feet during a severe frontal impact. • Laminated windscreen • Side-impact protection beams • Reinforced passenger safety cell • Deformation zones front and rear
- Burst-proof door locks and anti-jam door design

Pedestrian safety

- Bonnet / headlight / wiper structure – Designed to reduce pedestrian head and upper body injuries.
- Upper and lower bumper design – Reduces upper and lower leg injuries.

Stability

Electronic Stability Programme (ESP):

– Works in conjunction with the vehicle's electronic braking and engine systems to keep the car stable in many different situations. ESP monitors many different inputs to determine when the car starts to lose traction, it can then immediately respond by varying the brake pressure between up to three wheels and adjust the engine output to help correct the loss of traction and improve stability.

Additional ESP features:

- Traction control • Cornering brake control • Straight line stability control • Rollover mitigation • Drag torque control – Maintain stability on slippery roads when lifting off the accelerator or changing gear.

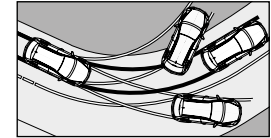

Braking

Anti-lock Braking System (ABS):

– Prevents the vehicle's wheels from locking up under heavy braking by momentarily reducing brake pressure at the appropriate wheel, ensuring that you can maintain control of the steering.

Additional braking features:



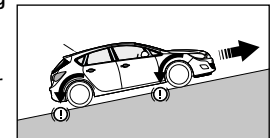





- The same electronic systems used in the ABS and ESP also deliver exceptional braking performance.
- Emergency brake assist – When emergency braking is detected the vehicle automatically applies the maximum possible braking assistance. • Hazard warning lights • Fading brake support – Compensates for the effects of brake fade. • Electronic brakeforce distribution – Automatically apportions the optimum braking force to each wheel. • Adaptive brake lights – Automatically warns other road users of heavy braking. • Hill start assist – Briefly maintains rear brake pressure to stop the vehicle rolling back on an incline.

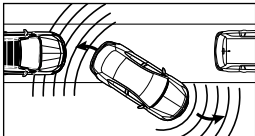

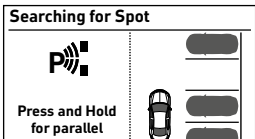
Tyre pressure

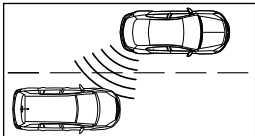

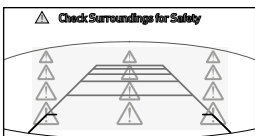





- Tyre pressure monitoring system

ASTRA FEATURES / OPTIONS

DRIVER ASSISTANCE		Design	Tech Line Nav	SRI	SRI VX-Line	Elite Nav	Ultimate	Price (£) exc. VAT	Total (£) inc. VAT
Cruise control with speed limiter Cruise control enables you to maintain a constant speed – making it ideal for economical motorway driving. The speed limiter function can be set to ensure that you do not exceed the speed limit and can be easily overridden if required. • Steering wheel mounted controls		●	●	●	●	●	●		
Front and rear parking distance sensors (not available with Parking Pack) • Front and rear parking distance sensors • Audible warning • Distance warning graphic shown in driver information display 		○	○	○	○	○		400.00	480.00
 Easier parking									
Parking Pack (includes front and rear parking distance sensors) Intelligent ultrasonic sensors form part of the solution for today's crowded roads and car parks – delivering exceptional assistance both when parking and protecting you on the open road. Advanced park assist: Advanced park assist not only detects suitable parking spaces but also expertly steers into them for you. All you have to do is to drive forward or reverse. The system works with both parallel and bay parking. • Ultrasonic side sensors with four-metre range • Ultrasonic front and rear parking sensors with a two-metre range • Fully automated steering • Detailed forward/reverse instructions are shown in the instrument cluster 									
 Finds suitable parking spaces									
 Auto steers into the parking space for you									
Side blind spot alert: Side blind spot alert helps prevent potential collisions with other vehicles 'hidden' in the vehicle's side blind spots. If a vehicle enters one of the blind spots a warning light illuminates in the relevant door mirror. • Ultrasonic side sensors with three-metre range • LED warning light in door mirrors • Audible warning is sounded if the indicators are used and the system has detected another vehicle • Electrically folding door mirrors (fitted as standard on Elite Nav models) 				○	○	○	●	625.00	750.00
 Warns of vehicles in your blind spot									
Rear-view camera: The rear-view camera gives a clear view of the area behind your car and helps place the car perfectly, without needing to strain your neck. • Activated when reverse gear selected • Camera view appears in infotainment screen • Rear bumper and one-metre grid lines shown as reference points 									
 See what's behind you on the central screen									
Sport switch Enables the driver to change the steering feel and throttle response for a sportier driving style. • Facia mounted sport switch				●	●				

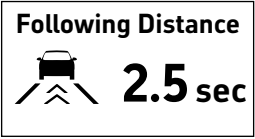
● = Standard equipment. ○ = Optional at extra cost.

ASTRA FEATURES / OPTIONS

	Design	Tech Line Nav	SRI	SRI VX-Line	Elite Nav	Ultimate	Price (£) exc. VAT	Total (£) inc. VAT
DRIVER ASSISTANCE Electric parking brake • Centre console switch in lieu of handbrake lever • Premium centre console featuring adjustable armrest			○	○	●	●	195.83	235.00
Driving Assistance Pack One <i>A wide range of class-leading driver assistance and safety features are controlled by the front camera system.</i> Forward collision alert with automatic city emergency braking: <i>In certain circumstances and at speeds above 5mph warns when approaching another vehicle too quickly. At speeds above 5mph and up to 53mph the system provides additional braking support to help the driver brake more quickly and effectively in an emergency situation. At speeds above 5mph and up to 37mph if no avoiding action is taken by the driver, the system automatically slows the vehicle with emergency braking.</i> • Visual warnings – shown in the instrument cluster • Audible warning • Additional braking support • Low speed collision mitigation braking 								
 Warns you of potential accidents Traffic sign recognition: <i>Detects and then displays speed limits, reducing uncertainty and the risk of speeding.</i> • Recognises different road signs, including temporary speed restrictions • Displays reminder in the driver information centre 	○	○	●	●			679.17	815.00
 Always know the speed limit Following distance indicator: <i>Indicates how many seconds you are behind the vehicle in front – helping you maintain a safe distance.</i> • Timings are shown in the driver information centre 					○	●	479.17	575.00
 Helps maintain a safe distance Lane departure warning with lane assist: <i>If the driver has not actively steered or signalled, the lane departure warning system warns when the car moves outside of lane markings at speeds above 35mph. The lane keep assist function additionally provides gentle steering correction to help drivers keep in their lane if no active inputs are made.</i> • Warning light in the instrument cluster • Audible warning • Steering wheel 'nudge' warning • Facia on / off switch • Both systems switch to standby when in road works or when road markings are confused <i>Please note: Design and Tech Line Nav models are upgraded to include</i> • Twin front reading lights with illuminated switches • Twin rear reading lights with illuminated switches • Ambient LED facia/centre console downlighter • Driver's and front passenger's illuminated vanity mirrors with flip-up covers • Automatic lighting control with tunnel detection • Automatically dimming anti-dazzle rear-view mirror • Rain-sensitive windscreen wipers 								
 Helps keep you in lane Steering • Speed sensitive electrically assisted power steering	●	●	●	●	●	●		

● = Standard equipment. ○ = Optional at extra cost.

ASTRA FEATURES / OPTIONS

	Design	Tech Line Nav	SRI	SRI VX-Line	Elite Nav	Ultimate	Price (£) exc. VAT	Total (£) inc. VAT
SECURITY								
Standard security features <ul style="list-style-type: none"> • 'Key left in ignition' audible warning • Electronically protected audio equipment • Engine deadlock immobiliser • Visible Vehicle Identification Number (VIN) • Locking wheel bolts for alloy wheels • Freewheeling door locks 	●	●	●	●	●	●		
Remote control central locking <ul style="list-style-type: none"> • Operates on doors, tailgate and fuel filler flap • Deadlocking • Central locking activation switch on facia • One folding key / one static key each with integral remote control function 	●	●	●	●	●	●		
Remote control ultrasonic security alarm system <ul style="list-style-type: none"> • Remote control (operates in conjunction with central locking) • Ultrasonic interior sensors • Tilt sensor • Thatcham approved <i>Please note: Design and Tech Line Nav models are upgraded to include</i> <ul style="list-style-type: none"> • Twin front reading lights with illuminated switches • Twin rear reading lights with illuminated switches • Ambient LED facia / centre console downlighter • Driver's and front passenger's illuminated vanity mirrors with flip-up covers <i>Alarm system is standard on Tech Line Nav 1.6 (136PS) Turbo D SIS manual models, and optional on SRI 1.0 (105PS) Turbo SIS ecoTEC models, standard on all other SRI models.</i>	○	○	●	●	●	●	216.67	260.00

DRIVER INFORMATION

Instrumentation <ul style="list-style-type: none"> • Speedometer • Rev counter • Digital fuel gauge with low fuel level warning light • Digital water temperature gauge with warning light • Shift-up/down indication light – <i>Indicates when to change gear for optimum fuel economy.</i> 	●	●	●	●	●	●		
Driver information display (centrally located in instrument cluster) <ul style="list-style-type: none"> • Monochrome display (upgraded to colour on SRI Nav and Elite Nav models) • Displays trip computer data • Total mileage • Service-due indicator • Oil life • Tyre pressure monitoring system 	●	●	●	●	●	●		
Multi-function trip computer (displayed on driver information display) <ul style="list-style-type: none"> • Trip mileage • Vehicle range based on remaining fuel • Average speed • Average fuel economy • Instantaneous fuel economy • Driving time 	●	●	●	●	●	●		
Central facia display (format dependent on infotainment unit) <ul style="list-style-type: none"> • Digital clock with automatic RDS time adjustment • Outside air temperature with ice warning function • Audio information • Additional features dependent on infotainment unit (see infotainment for details) 	●	●	●	●	●	●		

● = Standard equipment. ○ = Optional at extra cost.

ASTRA FEATURES / OPTIONS

INTERIOR STYLING	Design	Tech Line Nav	SRi	SRi VX-Line	Elite Nav	Ultimate	Price (£) exc. VAT	Total (£) inc. VAT
Design interior décor Steering wheel: • Three-spoke design • Satin chrome-effect bezel Facia and door trim: • Black facia with Antelao Sand trim inserts • Instrument panel bar Polar Silver • Black door panels with black Atlantis cloth inserts • Polar Silver trim inserts on front doors • Chrome-effect interior door handles Seat trim: • Talino fabric seat trim inserts • Plain black fabric side bolsters and surrounds Headlining: • Titanium roof lining	●							
Tech Line Nav interior décor Steering wheel: • Three-spoke design • Leather-covered with accent stitching • Satin chrome-effect bezel Facia and door trim: • Black facia with Antelao Sand trim inserts • Instrument panel bar Polar Silver • Black door panels with black Atlantis cloth inserts • Polar Silver trim inserts on front doors • Chrome-effect interior door handles Seat trim: • Talino fabric seat trim inserts • Plain black fabric side bolsters and surrounds Headlining: • Titanium roof lining		●						
SRi / SRi VX-Line interior décor Steering wheel: • Three-spoke design • Leather-covered with accent stitching • Satin chrome-effect bezel Facia and door trim: • Black facia with Piano black trim inserts • Instrument panel bar Piano Black • Silver air vent surrounds • Black door panels with black Atlantis cloth inserts • Piano black trim inserts on front doors • Chrome-effect interior door handles Seat trim: • Formula fabric seat trim inserts • Plain black fabric side bolsters and surrounds Headlining: • SRi models – Titanium roof lining • SRi VX-Line models – Black roof lining			●	●				
Elite Nav / Ultimate interior décor with Siena leather seat trim Steering wheel: • Three-spoke design • Leather-covered with accent stitching • Satin chrome-effect bezel Facia and door trim: • Black facia with Piano black trim inserts • Instrument panel bar Satin Chrome • Silver air vent surrounds • Black door panels with black Leather-effect inserts • Piano black trim inserts on front doors • Chrome-effect interior door handles Seat trim: • Black Siena leather seat trim inserts • Black leather-effect side bolsters and surrounds Headlining: • Titanium roof lining Front door sill covers: • Alloy-effect					●	●		

● = Standard equipment. ○ = Optional at extra cost.

ASTRA FEATURES / OPTIONS

	Design	Tech Line Nav	SRI	SRI VX-Line	Elite Nav	Ultimate	Price (£) exc. VAT	Total (£) inc. VAT
SEATING AND COMFORT								
Reach and rake adjustable steering	●	●	●	●	●	●		
Comfort front seats Driver's seat (eight way adjustable): • Height (up/down) • Reach (fore/aft) • Backrest recline (upright/incline) • Head restraint (up/down) Front passenger's seat (six way adjustable): • Reach (fore/aft) • Backrest (upright/recline) • Head restraint (up/down)	●	●						
Driver's ergonomic active seat – AGR certified* with sports-style front passenger seat featuring Formula cloth Driver's seat (16-way adjustable): • Height (up/down) • Reach (fore/aft) • Tilt (fore/aft) • Backrest (upright/recline) • Seat cushion extension (fore/aft) • Lumbar adjustment (four-way electrical) • Head restraint (up/down) Front passenger's seat (six way adjustable): • Reach (fore/aft) • Backrest (upright/recline) • Head restraint (up/down)	○	○	●	●			216.67	260.00
Sports style front seats featuring Siena Leather Driver's and front passenger's seat (12-way adjustable): • Height (up/down) • Reach (fore/aft) • Backrest (upright/recline) • Lumbar adjustment (four-way electrical) • Head restraint (up/down) • Heated front and outer rear seats • Centre rear armrest					●			
Driver's and front passenger's ergonomic active seats – AGR certified* – Changes seat trim to perforated leather on Elite Nav models Driver's and front passenger's seat (16-way adjustable): • Height (up/down) • Reach (fore/aft) • Tilt (fore/aft) • Backrest (upright/recline) • Seat cushion extension (fore/aft) • Lumbar adjustment (four-way electrical) • Head restraint (up/down)					○	●	170.83	205.00
Driver's Ergonomic Active Seat with Wellness Functions – AGR certified* (only available with optional driver's & front passenger's ergonomic active seats – AGR certified) Driver's seat additional features: • Massage function via three air cushions • Active ventilation backrest/seat cushion • Electrically operated adjustment with seat memory function • Pneumatically adjustable backrest side bolsters Front passenger's seat additional feature: • Active ventilation backrest/seat cushion					○	○	595.83	715.00
Rear seating • Three person layout • Three height-adjustable and removable head restraints • ISOFIX child seat mountings incorporating top tether anchor points located on outer rear seats (does not include child seat) – Allows ISOFIX child safety seats to be securely fixed into the car. The ISOFIX mounting system reduces forward movement in an accident and makes the child seat easier to install. • Child-proof locks on rear doors	●	●	●	●	●	●		
• 60/40 split-folding rear seat back	●	●	●	●				
• 40/20/40 split-folding rear seat back • FlexFold rear seats with remote electrical release (Sports Tourer only) • Leather trim only					●	●		

● = Standard equipment. ○ = Optional at extra cost. * = AGR (The Campaign for Healthier Backs) is an independent centre of excellence for ergonomics, based in Germany.

ASTRA FEATURES / OPTIONS

INFOTAINMENT

	Design	Tech Line Nav	SRI	SRI VX-Line	Elite Nav	Ultimate	Price (£) exc. VAT	Total (£) inc. VAT
<p>R4.0 IntelliLink touchscreen infotainment system</p> <p><i>For use with MP3 players, USB memory sticks, mobile phones and smartphone apps</i></p> <p>Onboard features:</p> <ul style="list-style-type: none"> • 7-inch colour touchscreen • DAB digital radio/AM/FM stereo radio with 36 station presets • RDS with Traffic Programme <p>Media connections:</p> <ul style="list-style-type: none"> • USB connection with iPod control • Bluetooth® A2DP audio streaming (Advanced Audio Distribution Profile) <p>Mobile phone portal:</p> <ul style="list-style-type: none"> • Bluetooth® connectivity • Handsfree calls via steering wheel controls • Vehicle microphone • Phone book access – <i>Contacts/last calls/missed calls etc. are mirrored on IntelliLink's display and are easily navigated using the touchscreen (features dependent on mobile phone).</i> <p>Smartphone interface:</p> <ul style="list-style-type: none"> • Apple CarPlay™ • Android Auto™ – <i>Smartphone projection that allows operations via voice command, touchscreen and buttons to control apps and music playback.</i> 	●		●	●				
<p>Navi R4.0 IntelliLink touchscreen infotainment system</p> <p><i>For use with MP3 players, USB memory sticks, mobile phones and smartphone apps</i></p> <p>Onboard features:</p> <ul style="list-style-type: none"> • 7-inch colour touchscreen • DAB digital radio/AM/FM stereo radio with 36 station presets • RDS with Traffic Programme <p>Navigation features:</p> <ul style="list-style-type: none"> • Satellite navigation system <p>Media connections:</p> <ul style="list-style-type: none"> • USB connection with iPod control • Bluetooth® A2DP audio streaming (Advanced Audio Distribution Profile) <p>Mobile phone portal:</p> <ul style="list-style-type: none"> • Bluetooth® connectivity • Handsfree calls via steering wheel controls • Vehicle microphone • Phone book access – <i>Contacts/last calls/missed calls etc. are mirrored on IntelliLink's display and are easily navigated using the touchscreen (features dependent on mobile phone).</i> <p>Smartphone interface:</p> <ul style="list-style-type: none"> • Apple CarPlay™ • Android Auto™ – <i>Smartphone projection that allows operations via voice command, touchscreen and buttons to control apps and music playback.</i> 		●						

● = Standard equipment.

ASTRA FEATURES / OPTIONS

INFOTAINMENT	Design	Tech Line Nav	SRI	SRI VX-Line	Elite Nav	Ultimate	Price (£) exc. VAT	Total (£) inc. VAT
Navi 900 IntelliLink touchscreen navigation and infotainment system <i>For use with MP3 players, USB memory sticks, mobile phones and smartphone apps</i> Onboard features: <ul style="list-style-type: none"> • 8-inch colour touchscreen • DAB digital radio/AM/FM stereo radio with 36 station presets • RDS with Traffic Programme • 60 configurable favourites including contacts, addresses, playlists, radio stations and voice recognition • Six premium speakers Navigation features: <ul style="list-style-type: none"> • Satellite navigation system • 3D street level mapping • European coverage Media connections: <ul style="list-style-type: none"> • USB connection with iPod control • Bluetooth® A2DP audio streaming (Advanced Audio Distribution Profile) Mobile phone portal: <ul style="list-style-type: none"> • Bluetooth® connectivity • Handsfree calls via steering wheel controls • Vehicle microphone • Phone book access – <i>Contacts/last calls/missed calls etc. are mirrored on IntelliLink's display and are easily navigated using the touchscreen (features dependent on mobile phone).</i> Smartphone interface: <ul style="list-style-type: none"> • Apple CarPlay™ • Android Auto™ – <i>Smartphone projection that allows operations via voice command, touchscreen and buttons to control apps and music playback.</i> 			▲	▲	●	●	591.67	710.00
CD drive (only available in conjunction with Navi 900 IntelliLink)			○	○	○	○	112.50	135.00
Four speakers (front)	●	●						
Six speakers (four front, two rear)			●	●	●	●		
Steering wheel mounted audio controls for phone, music and cruise control	●	●	●	●	●	●		
Twin USB power sockets for rear seat passengers					●	●		

● = Standard equipment. ○ = Optional at extra cost. ▲ = Standard on Nav models, see pricing page for details.

ASTRA FEATURES / OPTIONS

	Design	Tech Line Nav	SRI	SRI VX-Line	Elite Nav	Ultimate	Price (£) exc. VAT	Total (£) inc. VAT
HEATING AND VENTILATION Air conditioning <ul style="list-style-type: none"> • Air recirculation facility • Cabin particulate filter – Removes dust, airborne particles and pollen. • Multi-speed fan • Illuminated controls 	●	●	●	●				
Electronic climate control including air conditioning <ul style="list-style-type: none"> • Dual-zone control – Allowing different temperature settings for driver and front passenger. • Advanced predictive logic control system using sun and humidity sensors • Partial air recirculation – Faster warm up/cool down. • Cabin particulate filter – Removes dust, airborne particles and pollen. • Automatic air direction and fan speed with manual override • LCD temperature display • Illuminated controls <div style="display: flex; justify-content: space-between;"> <div style="background-color: #f0f0f0; padding: 2px;"> Set and forget temperature control</div> <div style="background-color: #f0f0f0; padding: 2px;"> Set different temperature for driver and front passenger</div> </div>			○	○	●	●	354.17	425.00
Additional features <ul style="list-style-type: none"> • Four adjustable facia vents • Windscreen demist vents • Side window demist vents • Heated rear screen with timed cut-off 	●	●	●	●	●	●		
Winter Pack <ul style="list-style-type: none"> • Heated leather-covered steering wheel • Heated front seats – Three temperature settings. • Rear floor heating ducts <div style="display: flex; align-items: center; margin-top: 5px;"> <div style="background-color: #f0f0f0; padding: 2px; margin-right: 10px;"> Warm welcome</div> <div style="display: flex; align-items: center; gap: 10px;"> </div> </div>	○	○	○	○	●	●	295.83	355.00

● = Standard equipment. ○ = Optional at extra cost.

ASTRA FEATURES / OPTIONS

INTERIOR CONVENIENCE / LIGHTING	Design	Tech Line Nav	SRI	SRI VX-Line	Elite Nav	Ultimate	Price (£) exc. VAT	Total (£) inc. VAT
Convenience features • Front 12-volt electrical accessory socket • Driver's and front passengers sunvisors • Front passenger vanity mirror • Dipping rear-view mirror	●	●	●	●	●	●		
Automatically dimming anti-dazzle rear-view mirror			●	●	●	●		
Front centre armrest with storage		●	●	●	●	●		
Twin USB power sockets for rear seat passengers – each socket provides 2.1 amps at 5 volts					●	●		
Standard lighting • Central front courtesy light • Central rear courtesy light • Fade up/fade down	●	●	●	●	●	●		
Premium lighting • Twin front reading lights with illuminated switches • Twin rear reading lights with illuminated switches • Ambient LED fascia/centre console downlighter • Driver's and front passenger's illuminated vanity mirrors with flip-up covers • Ambient LED lighting in front doors			●	●	●	●		
Interior storage • Fold out storage box on driver's side lower fascia • Glovebox with lid • Front door pockets • Two drinks holders in centre console • Rear door pockets • Storage compartment in centre console • Storage pockets on front seat backs	●	●	●	●	●	●		
Luggage area • Luggage compartment cover (Hatchback only) • Luggage compartment retractable cover (Sports Tourer only) • Illuminated load area • Fully carpeted load area • Interior tailgate handle • Four load restraint lashing eyes • Twin gas-assisted tailgate struts	●	●	●	●	●	●		

● = Standard equipment.

ASTRA FEATURES / OPTIONS

	Design	Tech Line Nav	SRI	SRI VX-Line	Elite Nav	Ultimate	Price (£) exc. VAT	Total (£) inc. VAT
EXTERIOR LIGHTING								
Standard lighting features								
<ul style="list-style-type: none"> • LED daytime running lights • Automatic lighting control: When the automatic lighting control is switched on, the system switches between daytime running lights and headlights automatically depending on external lighting conditions. • Halogen projector headlights • LED side repeat indicators • Lights-on audible warning: When keys are removed and driver door opened an audible warning sounds to alert the lights have been left on. • Manual headlight beam levelling: Use to adapt headlight range to the vehicle load to prevent dazzling. • High-level LED centre rear brake light • Rear fog light • Reversing light • Hazard warning lights • Door-to-door illumination: Headlights illuminate the area for an adjustable time after leaving the vehicle. 	●	●	●	●	●	●		
<ul style="list-style-type: none"> • Automatic lighting control with tunnel detection 			●	●	●	●		
IntelliLux LED Matrix headlights IntelliLux LED Matrix headlights work with the Driving Assistance Pack One incorporating front camera system, to provide outstanding lighting performance and enhanced safety. Each headlight features a matrix of eight individual LED lights. These lights replace the main beam function and supplement the dipped beam function. Each LED illuminates a separate part of the road ahead meaning that by automatically switching lights on and off, illumination is varied to suit traffic and road conditions. The IntelliLux system calculates which LED lights are activated and deactivated using additional data such as ambient light conditions, vehicle speed, steering angle and when the indicators are used. For example, when the front camera system detects an oncoming vehicle, the individual LED lights that would dazzle the oncoming driver are automatically switched off and then switched back on once the vehicle has passed. All other areas remain fully illuminated. Studies shown that the enhanced roadside illumination of IntelliLux LED Matrix headlights gives the driver an extra 1.5 seconds of reaction time at 50mph.								
<ul style="list-style-type: none"> • Dipped beam, main beam and dynamic lighting: 16 electronically controlled LED lights (eight per headlight) • Driving Assistance Pack One incorporating front camera system • Intelligent main beam control • Automatic headlight levelling • LED tail lights 			○	○		●	1041.67	1250.00
<ul style="list-style-type: none"> ✔ Smart headlights automatically adjust the shape of high beam 					○		1520.83	1825.00
<ul style="list-style-type: none"> ✔ No need to switch between high and low beam ✔ High beam is always glare free 								
Every type of driving environment has been considered: Urban light: With street lighting and speeds up to 34mph, the system automatically enhances the dipped beam function. Highway light: The system recognises when the car is on a dual carriageway or motorway. At higher speeds the light distribution on the right is reduced to minimise glare from the crash barriers. Country light: As speeds increase, so does the lighting's performance. Static Cornering light: At lower speeds corners and bends are illuminated to match steering inputs. Parking light: When reversing, additional side-facing lights are activated in the headlights. Energy saving mode: On Start/Stop models, the IntelliLux LED Matrix system goes into Energy saving mode when the engine is automatically stopped.								
LED tail lights: (standard with IntelliLux LED Matrix headlights)			○	○	○	●	170.83	205.00
Front fog lights	●	●	●		●	●	150.00	180.00



● = Standard equipment. ○ = Optional at extra cost.

ASTRA FEATURES / OPTIONS

	Design	Tech Line Nav	SRI	SRI VX-Line	Elite Nav	Ultimate	Price (£) exc. VAT	Total (£) inc. VAT
EXTERIOR CONVENIENCE / STYLING								
Keyless entry and start • Two transmitter fobs • Engine Start/Stop button • Back-up key			○	○	○	○	337.50	405.00
Power tailgate • With under bumper release sensor (Sports Tourer only) – <i>Only available in conjunction with optional keyless entry and start</i>			○		○		300.00	360.00
 Swipe foot under rear bumper								
Windscreen wipers • Two-speed windscreen wipers with variable intermittent wipe • Intermittent rear window wash/wipe	●	●	●	●	●	●		
• Rain-sensitive windscreen wipers			●	●	●	●		
Door mirrors • Twin electrically adjustable/heated door mirrors • Manually folding door mirrors	●	●	●	●				
• Electrically folding door mirrors					●	●		
Windows • Electrically operated front and rear windows with safety autoreverse and one-touch up/down facility • Heated rear window	●	●	●	●	●	●		
• Solar heat-absorbing windscreen • Tinted windows	●	●	●	●	●	●		
• Dark-tinted rear windows	●	●	○	○	○	●	237.50	285.00
Power tilt and slide sunroof • Manually operated sunblind • Sunroof can be closed remotely from outside of the vehicle <i>Please note: Design and Tech Line Nav models are upgraded to include:</i>								
• Twin front reading lights with illuminated switches	○	○	○	○	○	○	458.33	550.00
• Driver's and front passenger's illuminated vanity mirrors with flip-up covers								
• Twin rear reading lights with illuminated switches								
Roof rails (Sport Tourer only) • Black	●	●						
• Silver-effect			●		●			
Towing Pack • Detachable tow bar • Trailer stability programme integrated into ESP system <i>Please note: Not available with optional VX-Line Styling Pack on Elite Nav and Ultimate models</i>								
	○	○	○		○	○	504.17	605.00
Body styling • Chrome-effect front grille bar • Chrome-effect headlight detail • Body-colour door handles	●	●	●	●	●	●		
• Body-colour door mirrors • Body-colour rear roof spoiler								
• Chrome-effect upper window trim			●	●	●	●		
• Matt black B-pillars • Gloss black C-pillars	●	●						
• Gloss black B-pillars • Gloss black C-pillars			●	●	●	●		
VX-Line Styling Pack (Hatchback models only) • Sports-style front and rear bumpers • Side sills <i>Please note: Deletes front fog lights, not available with 1.0i Turbo (105PS) or 1.6CDTi (110PS) S/S ecoTEC models. Not available with optional Towing Pack or Aegean Blue and Flip Chip Silver exterior colours</i>				●	○	○	829.17	995.00

● = Standard equipment. ○ = Optional at extra cost.





ASTRA FEATURES / OPTIONS

EXTERIOR COLOURS		<i>Design</i>	<i>Tech Line Nav</i>	<i>SRi</i>	<i>SRi VX-Line</i>	<i>Elite Nav</i>	<i>Ultimate</i>	Price (£) exc. VAT	Total (£) inc. VAT
	Aegean Blue • Solid paint	●	●	●		●	●		
	Summit White • Brilliant paint	○	○	○	○	○	○	237.50	285.00
	Lava Red • Brilliant paint								
	Sovereign Silver • Two-coat metallic paint								
	Mineral Black • Two-coat metallic paint								
	Flip Chip Silver • Two-coat metallic paint • Not available on SRi VX-Line models	○	○	○	○	○	○	479.17	575.00
	Cosmic Grey • Two-coat metallic paint								
	Darkmoon Blue • Two-coat premium paint								
	Dark Caramel • Two-coat premium paint • No-cost option on SRi VX-Line models								
	Emerald Green • Two-coat premium paint	○	○	○	○	○	○	545.83	655.00

● = Standard equipment. ○ = Optional at extra cost.

The colours reproduced may vary slightly from the actual paint colour. As a result they should be used as a guide only. Your Vauxhall Retailer has a comprehensive display of our paint samples.





ASTRA FEATURES / OPTIONS

WHEELS AND TYRES		<i>Design</i>	<i>Tech Line Nav</i>	<i>SRI</i>	<i>SRI VX-Line</i>	<i>Elite Nav</i>	<i>Ultimate</i>	Price (£) exc. VAT	Total (£) inc. VAT
Steel emergency spare wheel (in lieu of emergency tyre inflation kit) Loadspace capacity is reduced.		○	○	○	○	○	○	91.67	110.00
Full-size 16-inch steel spare wheel (in lieu of emergency tyre inflation kit) Sports Tourer only, not available with optional 17-inch alloy wheels.		○	○					91.67	110.00
	16-inch alloy wheels • 205/55 R 16 tyres • Emergency tyre inflation kit (in lieu of spare wheel)	●	●						
	16-inch structure wheels • 205/55 R 16 tyres • Emergency tyre inflation kit (in lieu of spare wheel)	N/C	N/C					No-cost option	
	17-inch 10-spoke alloy wheels • 225/45 R 17 tyres • Emergency tyre inflation kit (in lieu of spare wheel)	○	○					400.00	480.00
	17-inch five twin-spoke alloy wheels • 225/45 R 17 tyres • Emergency tyre inflation kit (in lieu of spare wheel)			●					

● = Standard equipment. ○ = Optional at extra cost. N/C = No-cost option.



ASTRA FEATURES / OPTIONS

WHEELS AND TYRES

	Design	Tech Line Nav	SRI	SRI VX-Line	Elite Nav	Ultimate	Price (£) exc. VAT	Total (£) inc. VAT
 <p>17-inch multi-spoke alloy wheels</p> <ul style="list-style-type: none"> • 225/45 R 17 tyres • Emergency tyre inflation kit (in lieu of spare wheel) 					●			
 <p>17-inch gloss black five twin-spoke alloy wheels</p> <ul style="list-style-type: none"> • 225/45 R 17 tyres • Emergency tyre inflation kit (in lieu of spare wheel) 			○		○		83.33	100.00
 <p>18-inch bi-colour alloy wheels</p> <ul style="list-style-type: none"> • 225/40 R 18 tyres • Emergency tyre inflation kit (in lieu of spare wheel) • Not available with 1.0i Turbo (105PS) or 1.6CDTi (110PS) ecoTEC engines 			○		○	●	400.00	480.00
 <p>18-inch five twin-spoke alloy wheels</p> <ul style="list-style-type: none"> • 225/40 R 18 tyres • Emergency tyre inflation kit (in lieu of spare wheel) • Not available with 1.0i Turbo (105PS) or 1.6CDTi (110PS) ecoTEC engines 			○	●			400.00	480.00

● = Standard equipment. ○ = Optional at extra cost.

TYRE RATING

Tyre size	Fuel efficiency group	Wet grip performance	External noise	
			Measured (dB)	Group
205/55 R 16	B-C	A-C	70-71	
225/45 R 17	C	A-B	71	
225/40 R 18	E	B	70	

Tyre rating according to EU Regulation 1222/2009

ASTRA SPECIFICATIONS

PETROL ENGINES

	1.0i Turbo (105PS) with Start/Stop	1.4 Turbo (125PS)	1.4 Turbo (150PS) manual
Capacity	999cc	1399cc	1399cc
Maximum power	105PS (77kW) @ 5500rpm	125PS (92kW) @ 4000-5600rpm	150PS (110kW) @ 5000-5600rpm
Maximum torque	170Nm (125 lb.ft.) @ 1800-4250rpm	245Nm (180lb.ft.) @ 2000-3500rpm	245Nm (180lb.ft.) @ 2000-4000rpm
Configuration	3 cylinders, 4 valves per cylinder, double overhead camshafts	4 cylinders, 4 valves per cylinder, double overhead camshafts	4 cylinders, 4 valves per cylinder, double overhead camshafts
Fuel/induction system	Water-cooled turbocharger with intercooler. Variable Valve Timing (VVT). Central direct fuel injection	Water-cooled turbocharger with intercooler. Variable Valve Timing (VVT). Central direct fuel injection	Water-cooled turbocharger with intercooler. Variable Valve Timing (VVT). Central direct fuel injection
Emission compliance	Euro 6d-TEMP (6.2). Gasoline Particulate Filter	Euro 6d-TEMP (6.2). Gasoline Particulate Filter	Euro 6d-TEMP (6.2). Gasoline Particulate Filter
Service interval	20,000 miles or 1 year (whichever occurs sooner)	20,000 miles or 1 year (whichever occurs sooner)	20,000 miles or 1 year (whichever occurs sooner)

	1.4i Turbo (150PS) auto with Start/Stop	1.6i Turbo (200PS) with Start/Stop
Capacity	1399cc	1598cc
Maximum power	150PS (110kW) @ 5000-5600rpm	200PS (147kW) @ 5500rpm
Maximum torque	245Nm (180 lb.ft.) @ 2000-4000rpm	300Nm (221 lb.ft.) @ 1650-4500rpm
Configuration	4 cylinders, 4 valves per cylinder, double overhead camshafts	4 cylinders, 4 valves per cylinder, double overhead camshafts
Fuel/induction system	Water-cooled turbocharger with intercooler. Variable Valve Timing (VVT). Central direct fuel injection	Water-cooled turbocharger with intercooler. Variable Valve Timing (VVT). Central direct fuel injection
Emission compliance	Euro 6d-TEMP (6.2). Gasoline Particulate Filter	Euro 6d-TEMP (6.2). Gasoline Particulate Filter
Service interval	20,000 miles or 1 year (whichever occurs sooner)	20,000 miles or 1 year (whichever occurs sooner)

DIESEL ENGINES

	1.6CDTi (110PS) Turbo diesel with Start/Stop	1.6CDTi (136PS) Turbo diesel with Start/Stop	1.6CDTi BiTurbo (150PS) with Start/Stop
Capacity	1598cc	1598cc	1598cc
Maximum power	110PS (81kW) @ 3500rpm	136PS (100kW) @ 3500-4000rpm	150PS (110kW) @ 4000rpm
Maximum torque	300Nm (221 lb.ft.) @ 1750-2000rpm	320Nm (236 lb.ft.) @ 2000-2250rpm	350Nm (258 lb.ft.) @ 1500-2250rpm
Configuration	4 cylinders, 4 valves per cylinder, double overhead camshafts	4 cylinders, 4 valves per cylinder, double overhead camshafts	4 cylinders, 4 valves per cylinder, double overhead camshafts
Fuel/induction system	Turbocharger with intercooler. Common rail fuel injection	Variable geometry turbocharger with intercooler. Common rail fuel injection	Two stage turbocharger with intercooler. Common rail fuel injection
Emission compliance	Euro 6d-TEMP (6.2). Diesel Particulate Filter	Euro 6d-TEMP (6.2). Diesel Particulate Filter	Euro 6d-TEMP (6.2). Diesel Particulate Filter
Service interval	20,000 miles or 1 year (whichever occurs sooner)	20,000 miles or 1 year (whichever occurs sooner)	20,000 miles or 1 year (whichever occurs sooner)

ASTRA SPECIFICATIONS

HATCHBACK PERFORMANCE, FUEL ECONOMY AND EMISSIONS

	Wheel size (inches)	Performance (manufacturer's figures)		Fuel economy mpg (litres/100km)#		CO ₂ emissions g/km*	Vehicle Excise Duty**		Benefit in kind company car taxation rates – 2018/19 tax year
		Maximum speed (mph)	Acceleration 0-60mph (sec)	Combined Low	Combined High		First year rate	Standard rate	
Manual									
1.0i Turbo (105PS) S/S ecoTEC	16	121	10.9	45.6 (6.2)	50.4 (5.6)	107	£145	£140	22%
1.0i Turbo (105PS) S/S ecoTEC	17	121	10.9	45.6 (6.2)	50.4 (5.6)	110	£145	£140	23%
1.4i Turbo (125PS)	16	127	8.6	41.5 (6.8)	46.3 (6.1)	133	£205	£140	27%
1.4i Turbo (125PS)	17	127	8.6	41.5 (6.8)	46.3 (6.1)	135	£205	£140	28%
1.4i Turbo (150PS)	17	134	7.8	42.8 (6.6)	45.6 (6.2)	136	£205	£140	28%
1.4i Turbo (150PS)	18	134	7.8	42.8 (6.6)	45.6 (6.2)	138	£205	£140	28%
1.6i Turbo (200PS) S/S	17	146	7.3	39.2 (7.2)	41.5 (6.8)	147	£205	£140	30%
1.6i Turbo (200PS) S/S	18	146	7.3	39.2 (7.2)	41.5 (6.8)	151	£515	£140	31%
1.6CDTi (110PS) S/S ecoTEC BlueInjection	16	124	10.4	53.3 (5.3)	60.1 (4.7)	107	£165	£140	26%
1.6CDTi (110PS) S/S ecoTEC BlueInjection	17	124	10.4	53.3 (5.3)	60.1 (4.7)	110	£165	£140	27%
1.6CDTi (136PS) S/S BlueInjection	16	132	8.8	52.3 (5.4)	58.9 (4.8)	116	£205	£140	28%
1.6CDTi (136PS) S/S BlueInjection	17	132	8.8	52.3 (5.4)	58.9 (4.8)	118	£205	£140	28%
1.6CDTi (136PS) S/S BlueInjection	18	132	8.8	52.3 (5.4)	58.9 (4.8)	121	£205	£140	29%
1.6CDTi BiTurbo (150PS) S/S BlueInjection	17	140	8.5	49.6 (5.7)	54.3 (5.2)	130	£205	£140	31%
1.6CDTi BiTurbo (150PS) S/S BlueInjection	18	140	8.5	49.6 (5.7)	54.3 (5.2)	133	£515	£140	31%
Automatic									
1.4i Turbo (150PS) S/S	16	130	8.2	37.7 (7.5)	42.8 (6.6)	130	£165	£140	27%
1.4i Turbo (150PS) S/S	17	130	8.2	37.7 (7.5)	42.8 (6.6)	134	£205	£140	27%
1.4i Turbo (150PS) S/S	18	130	8.2	37.7 (7.5)	42.8 (6.6)	139	£205	£140	28%
1.6CDTi (136PS) S/S BlueInjection	16	129	9.4	48.7 (5.8)	52.3 (5.4)	122	£205	£140	29%
1.6CDTi (136PS) S/S BlueInjection	17	129	9.4	48.7 (5.8)	52.3 (5.4)	126	£205	£140	30%
1.6CDTi (136PS) S/S BlueInjection	18	129	9.4	48.7 (5.8)	52.3 (5.4)	130	£205	£140	31%

S/S = Start/Stop.

= Fuel consumption figures are determined according to the WLTP test cycle. Full data relating to WLTP test cycles can be found at: www.vauxhall.co.uk/wltp*CO₂ emissions figures are determined according to the WLTP test cycle however, a Government formula is then applied to translate these figures back to what they would have been under the outgoing NEDC test cycle, which WLTP replaces. The correct tax treatment is then applied.Figures are intended for comparability purposes only. The fuel consumption you achieve under real life driving conditions and CO₂ produced will depend upon a number of factors, including the accessories fitted after registration, variations in driving styles, weather conditions and vehicle load. Only compare fuel consumption and CO₂ with other vehicles tested using the same technical procedures. For more information contact your local Vauxhall Retailer.

** = Correct at time of publication.

ASTRA SPECIFICATIONS

SPORTS TOURER PERFORMANCE, FUEL ECONOMY AND EMISSIONS

	Wheel size (inches)	Performance (manufacturer's figures)		Fuel economy mpg (litres/100km)#		CO ₂ emissions g/km*	Vehicle Excise Duty**		Benefit in kind company car taxation rates – 2018/19 tax year
		Maximum speed (mph)	Acceleration 0-60mph (sec)	Combined Low	Combined High		First year rate	Standard rate	
Manual									
1.0i Turbo (105PS) S/S ecoTEC	16	121	11.1	44.8 (6.3)	50.4 (5.6)	107	£145	£140	22%
1.0i Turbo (105PS) S/S ecoTEC	17	121	11.1	44.8 (6.3)	50.4 (5.6)	110	£145	£140	23%
1.4i Turbo (125PS)	16	127	9.0	41.5 (6.8)	45.6 (6.2)	136	£205	£140	28%
1.4i Turbo (125PS)	17	127	9.0	41.5 (6.8)	45.6 (6.2)	138	£205	£140	28%
1.4i Turbo (150PS)	17	134	8.2	42.2 (6.7)	45.6 (6.2)	139	£205	£140	28%
1.4i Turbo (150PS)	18	134	8.2	42.2 (6.7)	45.6 (6.2)	141	£205	£140	29%
1.6i Turbo (200PS) S/S	17	146	7.4	38.7 (7.3)	41.5 (6.8)	147	£205	£140	30%
1.6i Turbo (200PS) S/S	18	146	7.4	38.7 (7.3)	41.5 (6.8)	151	£515	£140	31%
1.6CDTi (110PS) S/S ecoTEC BlueInjection	16	124	10.7	52.3 (5.4)	58.9 (4.8)	112	£205	£140	27%
1.6CDTi (110PS) S/S ecoTEC BlueInjection	17	124	10.7	52.3 (5.4)	58.9 (4.8)	116	£205	£140	28%
1.6CDTi (136PS) S/S BlueInjection	16	132	9.0	52.3 (5.4)	57.7 (4.9)	118	£205	£140	28%
1.6CDTi (136PS) S/S BlueInjection	17	132	9.0	52.3 (5.4)	57.7 (4.9)	121	£205	£140	29%
1.6CDTi (136PS) S/S BlueInjection	18	132	9.0	52.3 (5.4)	57.7 (4.9)	125	£205	£140	30%
1.6CDTi BiTurbo (150PS) S/S BlueInjection	17	138	8.6	48.7 (5.8)	53.3 (5.3)	134	£515	£140	31%
1.6CDTi BiTurbo (150PS) S/S BlueInjection	18	138	8.6	48.7 (5.8)	53.3 (5.3)	137	£515	£140	32%
Automatic									
1.4i Turbo (150PS) S/S	17	130	8.6	37.2 (7.6)	42.8 (6.6)	134	£205	£140	27%
1.4i Turbo (150PS) S/S	18	130	8.6	37.2 (7.6)	42.8 (6.6)	138	£205	£140	28%
1.6CDTi (136PS) S/S BlueInjection	17	129	9.6	47.1 (6.0)	52.3 (5.4)	130	£205	£140	31%
1.6CDTi (136PS) S/S BlueInjection	18	129	9.6	47.1 (6.0)	52.3 (5.4)	134	£515	£140	31%

S/S = Start/Stop.

= Fuel consumption figures are determined according to the WLTP test cycle. Full data relating to WLTP test cycles can be found at: www.vauxhall.co.uk/wltp*CO₂ emissions figures are determined according to the WLTP test cycle however, a Government formula is then applied to translate these figures back to what they would have been under the outgoing NEDC test cycle, which WLTP replaces. The correct tax treatment is then applied.Figures are intended for comparability purposes only. The fuel consumption you achieve under real life driving conditions and CO₂ produced will depend upon a number of factors, including the accessories fitted after registration, variations in driving styles, weather conditions and vehicle load. Only compare fuel consumption and CO₂ with other vehicles tested using the same technical procedures. For more information contact your local Vauxhall Retailer.

** = Correct at time of publication.

ASTRA SPECIFICATIONS

INSURANCE GROUPS

	Design	Tech Line Nav	SRi	SRi Nav	SRi VX-Line	SRi VX-Line Nav	Elite Nav	Ultimate
1.0i Turbo (105PS) S/S ecoTEC	12E	11E	10E	10E	–	–	12E	–
1.4i Turbo (125PS)	14E	14E	–	–	–	–	–	–
1.4i Turbo (150PS)	–	–	16E	16E	16E	16E	18E	20E
1.4i Turbo (150PS) S/S auto	15E	16E	16E	16E	–	–	18E	20E
1.6i Turbo (200PS) S/S	–	–	21E	21E	–	20E	21E	24E
1.6CDTi (110PS) S/S ecoTEC	13E	13E	12E	12E	–	–	15E	–
1.6CDTi (136PS) S/S	19A	17E	15E	15E	15E	16E	18E	–
1.6CDTi (136PS) S/S auto	–	17E	15E	15E	–	–	18E	–
1.6CDTi BiTurbo (150PS) S/S	–	–	–	–	–	20E	23E	22E

S/S = Start/Stop.

ASTRA SPECIFICATIONS

TRANSMISSION

Five-speed manual gearbox

Standard on: 1.0i Turbo (105PS)

Six-speed manual gearbox

Petrol engines: 1.4i Turbo (125/150PS)/

1.6i (200PS) models

Diesel engines: 1.6CDTi (110/136PS)/

1.6CDTi BiTurbo (150PS) models

Six-speed automatic transmission with ActiveSelect® function

A six-speed automatic transmission is optional on 1.4i Turbo (150PS) and 1.6CDTi (136PS) models. On the road, a wide selection of shift patterns is adapted to the style and habits of the driver, anticipating when maximum acceleration or maximum efficiency is required. The electronic control will also adapt to the prevailing road conditions, reducing gear shifting when climbing or descending and using engine braking assistance during down changes.

The ActiveSelect® manual mode allows the gear lever to be used like a sequential manual gearbox – you simply push the lever forward or back to change up or down the gears. The driver also benefits from a 'neutral' gear disengagement at idle, which reduces vibration and contributes to improved fuel consumption.

BRAKING AND STABILITY

- Electronic Stability Programme (ESP)
- Cornering brake control
- Straight line stability control
- Rollover mitigation
- Drag torque control
- Hill start assist
- Anti-lock Braking System (ABS)
- Emergency brake assist
- Fading brake support
- Electronic brakeforce distribution
- Adaptive brake lights

1.0i Turbo (105PS) ecoTEC

Front ventilated discs: 276mm diameter

Rear discs: 264mm diameter

1.4i Turbo (125/150PS)

Front ventilated discs: 276mm diameter

Rear discs: 264mm diameter

1.6i Turbo (200PS)

Front ventilated discs: 300mm diameter

Rear discs: 264mm diameter

1.6CDTi (110PS) ecoTEC

Front ventilated discs: 276mm diameter

Rear discs: 264mm diameter

1.6CDTi (110/136PS)

Front ventilated discs: 300mm diameter

Rear discs: 264mm diameter

1.6CDTi BiTurbo (150PS)

Front ventilated discs: 300mm diameter

Rear discs: 288mm diameter

STEERING

- Power-assisted steering
- Turning circle (wall-to-wall): – 11.05m (36.2ft.)

WEIGHTS AND TOWING DATA kg

	Gross vehicle weight		Maximum towing weights Trailer with brakes (without brakes)	
	Hatchback	Sports Tourer	Hatchback	Sports Tourer
1.0i Turbo (105PS) S/S ecoTEC	1780	1850	1220 (610)	1150 (620)
1.4i Turbo (125PS)	1820	1890	1550 (620)	1500 (640)
1.4i Turbo (150PS)	1820	1890	1550 (620)	1500 (640)
1.4i Turbo (150PS) S/S automatic	1845	1915	1420 (620)	1420 (640)
1.6i Turbo (200PS) S/S	1890	1960	1700 (650)	1650 (680)
1.6CDTi (110PS) S/S ecoTEC	1850	1930	1400 (650)	1400 (670)
1.6CDTi (136PS) S/S	1875	1950	1650 (650)	1500 (680)
1.6CDTi (136PS) S/S automatic	1900	1975	1700 (650)	1500 (680)
1.6CDTi BiTurbo (150PS) S/S	1910	1985	1700 (680)	1700 (700)

Gross vehicle weight is the total permissible weight of the vehicle including passengers and their luggage. The maximum roof rack loading should not exceed 75kg on all models. The maximum towing weights are based on the ability of the car, with two occupants of 75kg each, to restart on a 12% gradient, which is approximately 1 in 8.3, at sea level. The permitted trailer load applies up to the specified incline and up to an altitude of 1000 metres above sea level. The permissible gross train weight decreases by 10% for every 1000 metres of additional altitude. Any extra weight, such as luggage or additional passengers, should be deducted from the maximum towing weight. With a trailer fully loaded, maximum noseweight should not exceed 75kg. Always fit Vauxhall towing attachments and accessories available from your Vauxhall Retailer. They are designed specifically for Vauxhall models and carry a 12-month guarantee. During trailer towing do not exceed a maximum speed of 60mph. This speed limit is also applicable in countries with higher permitted speeds for trailer-vehicle combinations. Pay attention to the local speed limits. For trailers with low driving stability and caravans the use of an oscillation damper is strongly recommended. S/S = Start/Stop.

SUSPENSION

Front: Independent. Lightweight MacPherson struts with gas-pressure dampers and coil springs. Anti-roll bar.

Rear: Lightweight compound crank rear axle with one-piece, hollow cast trailing arms. Built-in anti-roll bar. Progressive-rate double conical mini-block springs and gas-pressure dampers.

BODY

Aerodynamic drag co-efficient:
Hatchback – Cd 0.285
Sports Tourer – Cd 0.278

FUEL TANK CAPACITY

48 litres (10.5 gallons)

ASTRA SPECIFICATIONS

EXTERIOR DIMENSIONS millimetres (inches)

Hatchback

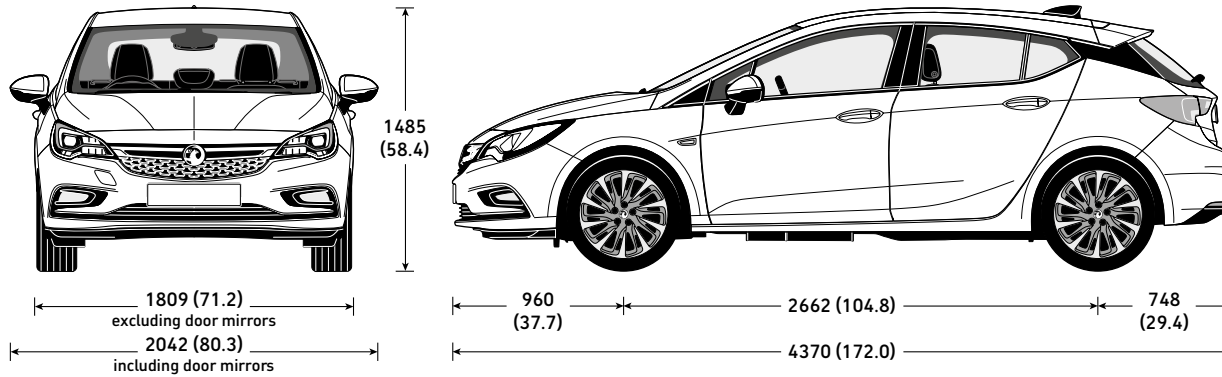

Sports Tourer

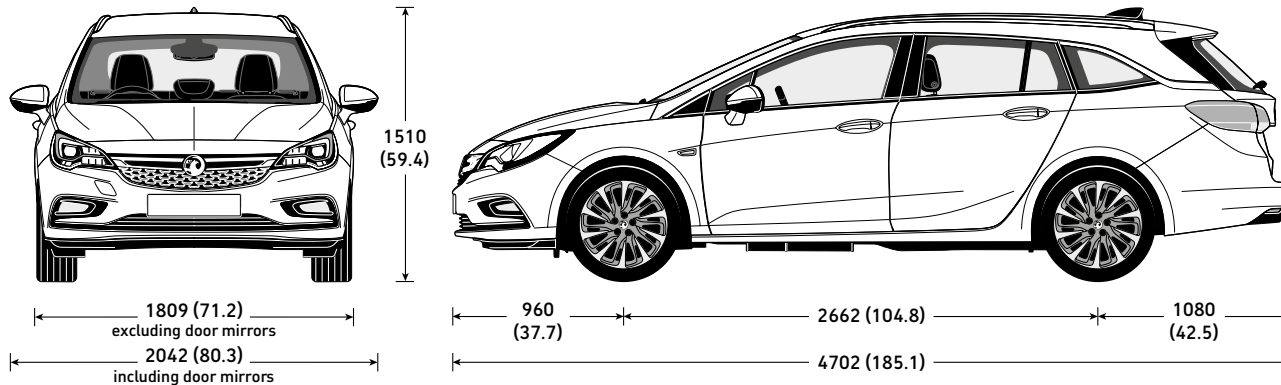

LOADSPACE DIMENSIONS mm (inches)

	Hatchback	Sports Tourer
Load floor length (rear seats folded)	1575 (62.0)	1705 (67.1)
Load floor length (behind rear seats)	828 (32.5)	1065 (41.9)
Load area width	1001 (39.4)	1050 (41.3)
Load area height	841 (33.1)	822 (32.3)
Tailgate aperture width (maximum)	1015 (39.9)	1032 (40.6)
Tailgate aperture height	600 (23.6)	747 (29.4)

LOADSPACE CAPACITIES* litres (cu.ft.)

	Hatchback	Sports Tourer
Rear seat up (under luggage compartment cover)	370 (13.0)	540 (19.0)
Rear seat down (measured to roof)	1210 (42.7)	1630 (57.5)

* = Measured using the ECIE method. When an optional spare wheel is specified loadspace capacity is reduced due to a raised luggage compartment floor.

ASTRA ACCESSORIES

	Total (inc. VAT)
CHILD SEATS²	
BABY-SAFE ³ – 0-13kg/birth to 15 months	£132
– ISOFIX base	£240
DUO ISOFIX ³ – 9-18kg/9 months to 4 years with top tether kit	£367
KID ³ – 15-36kg or 4 to 12 years	£166

² = Restrictions apply to the use of child seats, please consult your Vauxhall Retailer or request a copy of the Child seats brochure.

³ = Without transponder.

	Total (inc. VAT)
INTERIOR	
PowerFlex bar	from £115
Smartphone holder ⁴	£51
Air freshener holder ⁴	£43
Air freshener refill	£12
Cupholder insert	
– Tissue	£17
– Notepad	£17
– Make-up	£17
Interior trim kit – Shaded Maori	£145

⁴ = Only for use with PowerFlex Bar.

	Total (inc. VAT)
SAFETY	
Parking sensors	
– four fully flush front bumper mounted sensors	£323
– four fully flush rear bumper mounted sensors	£323
Safety Pack – first aid kit, warning triangle, hi-visibility vest, Vauxhall bag	£37
First aid kit	£15
Warning triangle	£18
Fire extinguisher – 2kg	£39
Hi-visibility vest	£9
Tyre repair kit	£154

	Total (inc. VAT)
FLEXCONNECT RANGE	
FlexConnect bracket	£21
FlexConnect hook	£31
FlexConnect coat hanger	£34
FlexConnect folding table	£76
FlexConnect iPad Mini cradle	£107
FlexConnect iPad (1-4) cradle	£116
FlexConnect iPad Air cradle	£115
FlexConnect Samsung Galaxy cradle	£105

	Total (inc. VAT)
PRACTICAL	
Spare bulb kit ⁵	£39
Spare bulb kit (white) ⁵	£38
Stretch tow rope – 3000kg	£35
Privacy shades	
– rear window (Hatchback)	£97
– rear side windows (Hatchback)	£85
– rear window (Sports Tourer)	£95
– rear side windows (Sports Tourer)	£107
Fog lamp wing kit	
– Carbon fibre	£104
– Brushed aluminium	£94

⁵ = Excludes xenon headlight bulb for models with Adaptive Forward Lighting (AFL).

	Total (inc. VAT)
PROTECTION	
Rubber floor mats – set of four	£59
Velour floor mats – set of four	£63
Economy floor mats – set of four	£29
Cargo liner ⁶	from £91
Cargo net – horizontal	£21
Cargo net – sidewall	£18
Cargo net – vertical (Sports Tourer)	£76
Tyre valve covers with Vauxhall logo (set of 4)	£23
Load compartment storage tray – hatchback only ⁷	£78
Mudflaps	
– front	£50
– rear ⁸ (Hatchback)	£52
– rear (Sports Tourer)	£58
Dog guard (Sports Tourer)	£192
Door mirror caps	
– Black	£91
– White	£127
Bumper load protection foil	£61

⁶ = On Hatchback – for vehicles with spare wheel. For vehicles without spare wheel, load compartment storage tray required to use cargo liner.

⁷ = For vehicles without spare wheel.

⁸ = Not available with certain exterior styling products.

	Total (inc. VAT)
TRANSPORT SYSTEMS	
Roof base carrier	from £214
Roof carriers (requires base carrier)	
Bike roof carrier – Thule Freeride 532	£78
Surf board roof carrier – Thule 833	£82
Kayak roof carrier – Thule 837	£172
Ski roof carrier – up to 4 pairs (400mm wide) – Thule 7324	£161
Ski roof carrier – up to 6 pairs (600mm wide) – Thule 7326	£190
Hard shell roof boxes (requires base carrier)	
Thule Ocean 80 (320 litre / 1330 x 860 x 370mm)	£154
Thule Ocean 200 (450 litre / 1750 x 820 x 450mm)	£323
Thule Motion 800 (460 litre / 2050 x 840 x 450mm)	from £463
Thule Touring 200 (400 litre / 1750 x 820 x 450mm)	£338
Thule Touring 700 (430 litre / 2320 x 700 x 420mm)	£378

	Total (inc. VAT)
Tow bar carrier system	
Fixed tow bar ⁹	£767
Detachable tow bar	from £706

⁹ = Available with 13-pin electrics. Sports Tourer only. Please consult your Vauxhall Retailers for details.

	Total (inc. VAT)
STYLING	
Door sill plates	£47
Illuminated door sill plates	£157
Stainless steel pedal covers	
– manual	£150
– automatic	£148

	Total (inc. VAT)
ALLOY WHEELS (set of four with centre caps)¹⁰	
17-inch 10 V-spoke	£1,014
18-inch 10 double-spoke	£1,590

¹⁰ = Different tyres and locking wheel bolts/nuts may be required at extra cost. Price excludes new tyres and locking wheel bolts/nuts, includes static wheel balancing.

Please note:
Prices shown are fully fitted and painted, where applicable and include VAT. Please check with your local Vauxhall Retailer for details. It is advisable to ensure your insurance policy is adequate to cover additional fitted accessories. Prices correct at time of publication.

ASTRA COMPANY CAR DRIVER/FLEET INFORMATION

DESIGN AND TECH LINE NAV HIGH SPEC, LOW P11D

Specifically developed for businesses and company car drivers alike, our Design and Tech Line Nav models are seriously fit for Fleet.

Design models all feature very low P11D values, generous standard specification, including Sat Nav on Design Nav models, and a choice of high tech ecoTEC engines for great fuel economy and low emissions.

For even more standard specification, step up to our Tech Line Nav range. Again you are guaranteed low P11D values, plus great standard kit including Sat Nav, Bluetooth®, USB connection, aux-in socket and digital radio.

With Design and Tech Line Nav you can take for granted low Whole Life Costs and low company car driver taxation.



COMPANY CAR DRIVER FREE 3 DAY TEST DRIVE

Our free* 3 Day Test Drive programme is open to all Company Car Drivers. It allows you to choose most models in the current Vauxhall line-up (exclusions apply). With full insurance cover provided, it gives you a meaningful length of time to make an informed decision about your next company car.

Search Vauxhall 3DTD to book your FREE* test drive or click the link the below:

[Vauxhall 3 Day Test Drive](#)

*The free 3 Day Test Drive programme is open to Company Car Drivers and Fleet Decision Makers. Available for UK Mainland only. Terms and conditions apply. Full terms and conditions can be found at vauxhallfleet.co.uk/testdrive/index/terms.

BENEFIT IN KIND COMPANY CAR TAXATION†

The car benefit charge will be the car's list price (including VAT, options and accessories fitted, delivery to Retailer and number plates, but excluding Vehicle Excise Duty and new vehicle first registration fee) multiplied by the percentage charge for the CO₂ emissions band in which the car falls (see table opposite). Multiply this figure by your personal income tax rate (20%†† for Basic Rate, 40%†† for Higher Rate) to calculate your annual benefit in kind tax liability.

Example:

Astra Tech Line Nav 1.6CDTi (110PS)	
Start/Stop ecoTEC 5-door hatchback (CO ₂ emissions 107g/km)	
On-the-road RRP	£21070.00
Deduct: Vehicle Excise Duty	(£165.00)
New vehicle first registration fee	(£55.00)
Effective list price	£20850.00
Add: Optional two-coat metallic paint	£575.00

List price for tax purposes (P11D value)	£21425.00
--	-----------

Car benefit charge	
2018-19 tax year (26%)	£5570.00
Benefit in kind tax liability (2018-19 tax year)	
Basic Rate (20%) tax payer	£1114.00
Higher Rate (40%) tax payer	£2228.00

† = Please note this Price Guide provides taxation information as a guide only. Vauxhall does not provide taxation guidance. Drivers should always take professional advice on their own tax position. †† = Excludes residents of Scotland.

BIK FOR SCOTTISH RESIDENTS

Effective 6 April 2018 the Scottish Government have introduced their own BIK taxation structure. This only applies to Company Car Drivers that are Scottish taxpayers. HMRC will determine whether or not an individual is a Scottish taxpayer based on where their main place of residence is.

The BIK rates for Scotland are:

- Over £11,850-£13,850 Starter Rate 19%
- Over £13,850-£24,000 Basic Rate 20%
- Over £24,000-£43,430 Intermediate Rate 21%
- Over £43,430-£150,000 Higher Rate 41%
- Above £150,000 Top Rate 46%

CO ₂ emissions in grams per kilometre	Percentage of car's price to be taxed	
	Non-Diesel† 2018-19 tax year	Diesel†† 2018-19 tax year
Up to 50	13	17
51-75	16	20
76-94	19	23
95-99	20	24
100-104	21	25
105-109	22	26
110-114	23	27
115-119	24	28
120-124	25	29
125-129	26	30
130-134	27	31
135-139	28	32
140-144	29	33
145-149	30	34
150-154	31	35
155-159	32	36
160-164	33	37
165-169	34	37
170-174	35	37
175-179	36	37
180 and above	37	37

† = Also applies to diesel vehicles that meet the Real Driving Emissions Step 2 (RDE2). †† = Applies to vehicles that do not meet the Real Driving Emissions Step 2 (RDE2).

To calculate your own personal liability, search: **Vauxhall BiK**, or click the link below:

[Vauxhall BiK Tool](#)

FLEET TOOLBOX

Discover the facts in our online Toolbox for both Company Car Drivers and Fleet Decision Makers.

The Fleet Toolbox has a host of useful calculators, comparators, interactive listings and information.

Search Vauxhall Fleet Tools or click the link below:

[Vauxhall Fleet Tool Box](#)



CONTACT VAUXHALL FLEET

Please contact one of our dedicated sales teams who will be happy to help with your particular enquiry.

Company Car Drivers

Call: 0345 111 2020

Email: company-car@vauxhallinfo.co.uk

Telephone lines are open

– Monday to Friday 8.00am-9.00pm

– Saturday and Sunday 9.00am-6.00pm

Fleet Decision Makers

Depending on the size of your fleet of vehicles, we have a dedicated team to handle your enquiries.

The lines are open Monday to Friday excluding Bank Holidays.

1-24 vehicles

Call: 0845 076 2254 (8.30am-5.00pm)

25+ vehicles

Call: 0330 587 8222 (8.30am-5.00pm)

Email: vauxhallfleet@vauxhall.co.uk

Special Vehicles (Police, Fire and Ambulance)

Call: 01582 409999 (8.30am-5.00pm)

Email: vauxhallspecialvehicles@vauxhall.co.uk

ASTRA ADDITIONAL INFORMATION

ON-THE-ROAD PRICES

To eliminate uncertainty about hidden costs when buying a new car, Vauxhall publishes on-the-road recommended retail prices (RRP) and these are shown in the pricing tables within this price guide. These prices include VAT, number plates and delivery to Retailer of £700.00 (including £116.67 VAT), 12 months' Government Vehicle Excise Duty (see opposite for details) and the DVLA new vehicle first registration fee of £55.00*.

Please note: The on-the-road recommended retail price (RRP) does not include fuel supplied by the Retailer, motor insurance or any other goods or services supplied by agreement between the Retailer and the customer.

PRICE PROTECTION

Order a new Vauxhall for build in the current model year (as confirmed by your Retailer) for delivery no more than three months in advance and the price you are quoted is the price you pay. This is irrespective of any subsequent price rises between placing your order and delivery of your new car, but you must take delivery as soon as the car is available. Vauxhall Motors Limited is not liable for price adjustments caused by Government changes in the rate of VAT (currently 20%), Vehicle Excise Duty, DVLA new vehicle first registration fee or by any other applicable legislation or regulations.

VAUXHALL FINANCE LEASING

Vauxhall Finance Leasing is a trading style of Vauxhall Finance plc. Working with the Vauxhall Retailer network we provide competitive car and van leasing solutions for business users and private individuals. We combine the support of a national contract with the convenience of a local contact. For further information, please contact your local Vauxhall Retailer or visit www.vauxhall.co.uk/leasing

IN THE EVENT OF AN ACCIDENT...

Vauxhall Accident Management helps keep you mobile following an accident. Benefits include vehicle recovery, Vauxhall-approved repairs and contacting your insurer. For more details, visit vauxhall.co.uk/AccidentManagement

VEHICLE EXCISE DUTY

The amount of Vehicle Excise Duty (road fund licence) payable on new cars varies depending on the level of carbon dioxide (CO₂) emissions produced by the vehicle. CO₂ emissions are measured in grammes (g) per kilometre (km) travelled and divided into 13 charging bands shown in the table below.

A 'first year rate' of Vehicle Excise Duty is payable on all new cars and in subsequent years the amount payable reverts to the 'standard rate'. From 1 April 2017 the breakpoints for each of these bands have been revised. Also, for vehicles with a list price over £40,000, including factory-fitted options, an additional £310 is payable for the first five years of standard rate payments.

VEHICLE EXCISE DUTY*

	CO ₂ emissions	First year rate		Standard rate
		Non-diesel**	Diesel†	
Band A	0g/km	£0.00	£0.00	£0.00
Band B	1 – 50g/km	£10.00	£25.00	£140.00
Band C	51 – 75g/km	£25.00	£105.00	£140.00
Band D	76 – 90g/km	£105.00	£125.00	£140.00
Band E	91 – 100g/km	£125.00	£145.00	£140.00
Band F	101 – 110g/km	£145.00	£165.00	£140.00
Band G	111 – 130g/km	£165.00	£205.00	£140.00
Band H	131 – 150g/km	£205.00	£515.00	£140.00
Band I	151 – 170g/km	£515.00	£830.00	£140.00
Band J	171 – 190g/km	£830.00	£1,240.00	£140.00
Band K	191 – 225g/km	£1,240.00	£1,760.00	£140.00
Band L	226 – 255g/km	£1,760.00	£2,070.00	£140.00
Band M	over 255g/km	£2,070.00	£2,070.00	£140.00

* = Correct at time of issue. ** = Also applies to diesel vehicles that meet the Real Driving Emissions Step 2 (RDE2).

† = Applies to vehicles that do not meet the Real Driving Emissions Step 2 (RDE2).

TRUST VAUXHALL

CUSTOMER CARE COMMITMENT

For added peace of mind, Vauxhall has an innovative Customer Care Commitment that offers the following:

- Three-year vehicle warranty consisting of a one-year/unlimited mileage manufacturer's warranty and a second and third year manufacturer's warranty with a 60,000 miles limitation
- Vauxhall Assistance for 12 months from first registration
- Six years' body panel anti-perforation warranty

Please note: Warranty is only available on vehicles sourced from Vauxhall Motors Limited. Terms and conditions apply – please see your Vauxhall Retailer for details.

VAUXHALL ASSISTANCE

Vauxhall Assistance is provided automatically with every new Vauxhall for 12 months from first registration and covers everything from accident assistance, roadside recovery and 'at home' service to flat tyres. With Vauxhall Assistance help is literally just a free* phone call away, 24 hours a day, 365 days a year!

* = Mobile phone users will be charged at their standard tariff.

PROTECTING THE ENVIRONMENT

Vauxhall's commitment to the environment is demonstrated by our products' many environmental awards. For even more information on Vauxhall's efforts to achieve an environmentally sustainable future, and how to dispose of your end-of-life vehicle, see www.vauxhall.co.uk/recycling

VAUXHALL SERVICE PLAN

- Fixed monthly payments for the plan duration
- Easy to budget and interest-free
- Genuine parts fitted by Vauxhall-trained technicians

Plus on Gold plans:

- Valet and courtesy car
- Full AA cover
- Engine flush and fuel treatments
- Litre of oil for top ups between services

Full details can be obtained from your local participating Vauxhall Retailer.

VAUXHALL INSURANCE WITH ADDED REASSURANCE

Comprehensive cover – Summary of benefits**

- Competitive premiums
- Repairs by a Vauxhall-trained technician
- Genuine Vauxhall parts, guaranteed for three years when we repair your car within our Approved Repairer Network
- Free courtesy car as standard when using an Approved Repairer†
- 24 hour claims helpline
- Personal Accident benefit
- Cover for audio equipment
- Windscreen cover

Call for a quote on 0844 463 2670††

** = The benefits listed above are for comprehensive cover only. For details of Third Party, Fire and Theft cover, please call our sales team.
† = Should your car need repairing following an accident we provide a courtesy car (subject to availability) for the duration of the repair. Only genuine Vauxhall parts are used. Terms and conditions apply.
†† = Calls may be recorded. Vauxhall Insurance is underwritten by Ageas Insurance Limited.

FOR MORE PRODUCT INFORMATION

For further information on the Vauxhall range or location of your nearest Vauxhall Retailer please call **0345 600 1500**. Alternatively, details can be found on our website at www.vauxhall.co.uk

JOIN US ONLINE:



Privacy Policy – For full details please visit: vauxhall.co.uk/privacy

The invoice price, including delivery to Retailer, factory-fitted options, accessories fitted by the Retailer and number plates, is subject to VAT. Some feature descriptions in this guide may refer to, and some illustrations may show, optional equipment not included in the standard delivery. The information contained in this guide was accurate at the time of publication. We reserve the right to make changes in design and equipment. Please note that Vauxhall Retailers are not the agents of Vauxhall Motors Limited and are not authorised to bind Vauxhall Motors Limited by any specific or implied undertaking or representation. It is advisable to ensure that your motor insurance policy provides adequate cover for additional fitted options and accessories. The colours in this guide are only approximate actual colours. Illustrated optional equipment is available at extra charge. Availability, technical features and equipment provided on our vehicles can vary by model. For precise information on the equipment provided on our vehicles, please contact your local Vauxhall Retailer.

VAUXHALL

vauxhall.co.uk

©2019 Vauxhall Motors Limited

Published 1 January 2019 (Amended 4 January 2019) Vauxhall Motors Limited