

MY 2022



Car Range

Price Guide

Price and Specification Guide
6 April 2022 | Model Year 2022D



Corsa

Contents

To find the information you want use the links below to navigate around the guide:

[PureTechnology](#)

[Choose Your Trim Level](#)

[Range Highlights](#)

[Models](#)

[Prices](#)

[PureSense](#)

[PureConnect](#)

[Comfort and Convenience](#)

[Safety and Security](#)

[Lighting](#)

[Styling](#)

[Exterior Colours](#)

[Wheels and Tyres](#)

[Specifications](#)

[Dimensions and Capacities](#)

[Accessories](#)

[Company Car Information](#)

[Further Information](#)

PureTechnology

The Corsa is an all-round class-leading car, with an advanced all-electric option and intuitive technology. Like IntelliLux adaptive LED[®] matrix headlights and state-of-the-art driver assistance systems.

Vauxhall PureTechnology

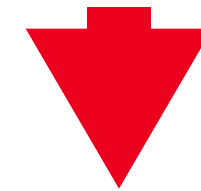

Vauxhall PureEnergy

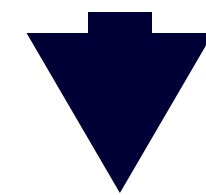

All-electric Corsa-e.

- 100% electric
- Total cost of ownership equal to petrol models
 - Up to 222 miles electric range
- Smooth 8-speed electrified automatic transmission

Vauxhall PureSense

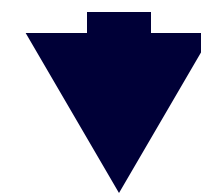

Intelligent automotive technology that's designed to give you unparalleled command and control of your every journey.

- IntelliLux adaptive LED[®] matrix headlights
- Intelli-Vision 360[°] panoramic parking camera
 - Adaptive cruise control
- Advanced intelligent speed adaption
 - Lane positioning assistant

Vauxhall PureConnect

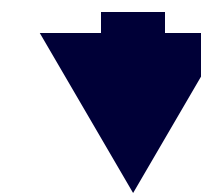

Intuitive connectivity that makes it simple to stay in touch, informed and entertained throughout day.

- 7 or 10-inch colour touchscreen
- Apple CarPlay/Android Auto[™]
 - Satellite Navigation
 - Vauxhall Connect

Choose Your Trim Level

Design



VX_COR_33355

First in the line-up is the wonderfully well-equipped Design.

GS Line



VX_COR_33356

For even more style, opt for GS Line. Sporty from the inside out. Relax in the sports style front seats and feel the power with the sport switch. Relax a little more with a host of premium features including rear parking sensors and climate control.

Also available as a 100% electric model.

Ultimate



VX_COR_32593

Ultimate is the top of the range Corsa available, with top of the range equipment on the inside and out. It looks the business with all the exterior equipment including, dark-tinted rear windows and IntelliLux adaptive LED[®] matrix headlights.

Also available as a 100% electric model.

Corsa-e Range Highlights

GS Line

Standard features include:

PureSense

- LED headlights
- LED daytime running lights
- High beam assist
- Electronic parking brake
- Lane departure warning with lane keep assist
- Speed sign recognition
- Driver drowsiness alert
- Automatic emergency city braking
- Cruise control with intelligent speed limiter
- Six airbags
- Rear parking distance sensors

PureConnect

- Multimedia Navi infotainment system
 - Satellite navigation
 - 7-inch colour touchscreen
 - AM/FM/DAB digital radio
 - Bluetooth®
 - Apple CarPlay/Android Auto™
 - USB connection
- 7-inch digital colour instrument cluster
- Six speakers
- Vauxhall Connect

Comfort and Convenience

- Electronic climate control
- Flat-bottomed leather-covered steering wheel
- 60/40 split-folding rear seats
- Electrically operated front and rear windows
- Electrically adjustable/heated door mirrors
- Front centre armrest with storage
- Rain-sensitive windscreen wipers
- Automatic lighting control
- Automatic anti-dazzle rear-view mirror
- Keyless start
- Remote control security alarm system

Styling

- 17-inch bi-colour alloy wheels
- High gloss black B-pillars
- Alloy-effect sports pedals

Ultimate

Features over GS Line models:

PureSense

- IntelliLux adaptive LED® matrix headlights with LED tail lights
- LED front fog lights
- Adaptive cruise control
- Enhanced automatic emergency city braking
- Front and rear parking distance sensors
- Panoramic rear-view camera

PureConnect

- Multimedia Navi Pro infotainment system – 10-inch colour touchscreen

Comfort and Convenience

- Heated steering wheel
- Heated sports style front seats
- Electrically folding door mirrors
- Alcantara seat trim
- Keyless entry

Styling

- Chrome-effect lower side window trim
- Dark tinted rear windows
- Black roof and A-pillars
- Black headliner

Please note: Ultimate models do not feature alloy-effect sports pedals.

Corsa Range Highlights

Design

Standard features include:

PureSense

- LED headlights
- LED daytime running lights
- High beam assist
- Electronic parking brake (auto models only)
- Lane departure warning with lane keep assist
- Speed sign recognition
- Driver drowsiness alert
- Forward collision alert
- Automatic emergency city braking
- Cruise control with intelligent speed limiter
- Six airbags

PureConnect

- Multimedia infotainment system
 - 7-inch colour touchscreen
 - AM/FM/DAB digital radio
 - Bluetooth®
 - Apple CarPlay/Android Auto™
 - USB connection
- Six speakers

Comfort and Convenience

- Air conditioning
- Flat-bottomed leather-covered steering wheel
- 60/40 split-folding rear seats
- Electrically operated front and rear windows
- Electrically adjustable/heated door mirrors
- Paddle shift (auto models only)
- Remote control central locking

Styling

- 16-inch silver alloy wheels

GS Line

Features over Design models:

PureSense

- LED tail lights
- LED front fog lights
- Electronic parking brake (excluding 75PS engine)
- Rear parking distance sensors
- Sport switch

PureConnect

- 7-inch digital colour instrument cluster

Comfort and Convenience

- Electronic climate control
- Front centre armrest with storage
- Rain-sensitive windscreen wipers
- Automatic lighting control
- Automatic anti-dazzle rear-view mirror
- Remote control security alarm system

Styling

- Sports front and rear body styling
- 17-inch black alloy wheels
- Chrome-effect exhaust tailpipe extension
- Dark-tinted rear windows
- Black roof and A-pillars
- High gloss black B-pillars
- Black headliner
- Alloy-effect sports pedals

Ultimate

Features over GS Line models:

PureSense

- IntelliLux adaptive LED® matrix headlights
- Adaptive cruise control (excluding auto models)
- Enhanced automatic emergency city braking
- Lane positioning assistant (excluding auto models)
- Front and rear parking distance sensors
- Panoramic rear-view camera

PureConnect

- Multimedia Navi Pro infotainment system
 - Satellite Navigation
 - 10-inch colour touchscreen
 - 2D/3D street level mapping
 - European coverage
 - Points-of-interest search
- Vauxhall Connect

Comfort and Convenience

- Heated sports-style front seats
- Heated steering wheel (excluding auto models)
- Electrically folding door mirrors
- Alcantara seat trim
- Driver's seat with massage function
- Keyless entry and start

Styling

- 17-inch bi-colour alloy wheels
- Chrome-effect lower side window trim

Corsa-e GS Line

VX_COR_e_33357



GS Line OTR from £27,055*

PureSense

- LED headlights
- LED daytime running lights
- High beam assist
- Electronic parking brake
- Lane departure warning with lane keep assist
- Speed sign recognition
- Driver drowsiness alert
- Automatic emergency city braking
- Cruise control with intelligent speed limiter
- Six airbags
- Rear parking distance sensors

PureConnect

- Multimedia Navi infotainment system
 - Satellite navigation
 - 7-inch colour touchscreen
 - AM/FM/DAB digital radio
 - Bluetooth®
 - Apple CarPlay/Android Auto™
 - USB connection
- 7-inch digital colour instrument cluster
- Six speakers
- Vauxhall Connect

Comfort and Convenience

- Electronic climate control
- Flat-bottomed leather-covered steering wheel
- 60/40 split-folding rear seats
- Electrically operated front and rear windows
- Electrically adjustable/heated door mirrors
- Front centre armrest with storage
- Rain-sensitive windscreen wipers
- Automatic lighting control
- Automatic anti-dazzle rear-view mirror
- Keyless start
- Remote control security alarm system

Styling

- 17-inch bi-colour alloy wheels
- High gloss black B-pillars
- Alloy-effect sports pedals

Corsa-e Ultimate

VX_COR_e_33358



Ultimate OTR from £29,660*

PureSense

- IntelliLux adaptive LED® matrix headlights with LED tail lights
- LED daytime running lights
- LED front fog lights
- High beam assist
- Electronic parking brake
- Lane departure warning with lane keep assist
- Speed sign recognition
- Driver drowsiness alert
- Adaptive cruise control
- Enhanced automatic emergency city braking
- Cruise control with intelligent speed limiter
- Six airbags
- Front and rear parking distance sensors
- Panoramic rear-view camera

PureConnect

- Multimedia Navi Pro infotainment system
 - Satellite navigation
 - 10-inch colour touchscreen
 - AM/FM/DAB digital radio
 - Bluetooth®
 - Apple CarPlay/Android Auto™
 - USB connection
- 7-inch digital colour instrument cluster
- Six speakers
- Vauxhall Connect

Comfort and Convenience

- Electronic climate control
- Flat-bottomed leather-covered steering wheel
- 60/40 split-folding rear seats
- Electrically operated front and rear windows
- Electrically adjustable/heated/folding door mirrors
- Heated steering wheel
- Heated sports style front seats
- Front centre armrest with storage
- Rain-sensitive windscreen wipers
- Automatic lighting control
- Automatic anti-dazzle rear-view mirror
- Keyless entry and start
- Remote control security alarm system
- Alcantara seat trim

Styling

- 17-inch bi-colour alloy wheels
- Chrome-effect lower side window trim
- Dark tinted rear windows
- Black roof and A-pillars
- High gloss black B-pillars
- Black headliner

Corsa Design

VX_COR_33355



Design

OTR from £17,340

PureSense

- LED headlights
- LED daytime running lights
- High beam assist
- Electronic parking brake (auto models only)
- Lane departure warning with lane keep assist
- Speed sign recognition
- Driver drowsiness alert
- Forward collision alert
- Automatic emergency city braking
- Cruise control with intelligent speed limiter
- Six airbags

PureConnect

- Multimedia infotainment system
 - 7-inch colour touchscreen
 - AM/FM/DAB digital radio
 - Bluetooth®
 - Apple CarPlay/Android Auto™
 - USB connection
- Six speakers

Comfort and Convenience

- Air conditioning
- Flat-bottomed leather-covered steering wheel
- 60/40 split-folding rear seats
- Electrically operated front and rear windows
- Electrically adjustable/heated door mirrors
- Paddle shift (auto models only)
- Remote control central locking

Styling

- 16-inch silver alloy wheels

Corsa GS Line

VX_COR_33356



GS Line

OTR from £19,490

PureSense

- LED headlights and tail lights
- LED daytime running lights
- LED front fog lights
- High beam assist
- Electronic parking brake (excluding 75PS engine)
- Lane departure warning with lane keep assist
- Speed sign recognition
- Driver drowsiness alert
- Forward collision alert
- Automatic emergency city braking
- Cruise control with intelligent speed limiter
- Six airbags
- Rear parking distance sensors
- Sport switch

PureConnect

- Multimedia infotainment system
 - 7-inch colour touchscreen
 - AM/FM/DAB digital radio
 - Bluetooth®
 - Apple CarPlay/Android Auto™
 - USB connection
- 7-inch digital colour instrument cluster
- Six speakers

Comfort and Convenience

- Electronic climate control
- Flat-bottomed leather-covered steering wheel
- 60/40 split-folding rear seats
- Electrically operated front and rear windows
- Electrically adjustable/heated door mirrors
- Paddle shift (auto models only)
- Front centre armrest with storage
- Rain-sensitive windscreen wipers
- Automatic lighting control
- Automatic anti-dazzle rear-view mirror
- Remote control security alarm system

Styling

- 17-inch black alloy wheels
- Sports front and rear body styling
- Chrome-effect exhaust tailpipe extension
- Dark-tinted rear windows
- Black roof and A-pillars
- High gloss black B-pillars
- Black headliner
- Alloy-effect sports pedals

Corsa Ultimate

VX_COR_32593



Ultimate OTR from £23,375

PureSense

- IntelliLux adaptive LED® matrix headlights with LED tail lights
- LED daytime running lights
- LED front fog lights
- High beam assist
- Electronic parking brake
- Lane departure warning with lane keep assist
- Speed sign recognition
- Driver drowsiness alert
- Forward collision alert
- Enhanced automatic emergency city braking
- Adaptive cruise control (excluding auto models)
- Six airbags
- Front and rear parking distance sensors
- Sport switch
- Lane positioning assistant (excluding auto models)
- Panoramic rear-view camera

PureConnect

- Multimedia Navi Pro infotainment system
 - 10-inch colour touchscreen
 - Satellite Navigation
 - 2D/3D street level mapping
 - European coverage
 - Points-of-interest search
 - AM/FM/DAB digital radio
 - Bluetooth®
 - Apple CarPlay/Android Auto™
 - USB connection
- 7-inch digital colour instrument cluster
- Six speakers
- Vauxhall Connect

Comfort and Convenience

- Electronic climate control
- Flat-bottomed leather-covered steering wheel
- 60/40 split-folding rear seats
- Electrically operated front and rear windows
- Electrically adjustable/heated/folding door mirrors
- Paddle shift (auto models only)
- Heated steering wheel (excluding auto models)
- Heated sports-style front seats
- Front centre armrest with storage
- Rain-sensitive windscreen wipers
- Automatic lighting control
- Automatic anti-dazzle rear-view mirror
- Keyless entry and start
- Remote control security alarm system
- Alcantara seat trim
- Driver's seat with massage function

Styling

- 17-inch diamond-cut bi-colour alloy wheels
- Sports front and rear body styling
- Chrome-effect exhaust tailpipe extension
- Chrome-effect lower side window trim
- Dark-tinted rear windows
- Black roof and A-pillars
- High gloss black B-pillars
- Black headliner
- Alloy-effect sports pedals

This vehicle is covered by our Price Protection Guarantee. See 'Further Information' page for details.

Corsa-e Prices

	Pack Code	Price (£)	VAT (£)	Total (£)	On-the-road RRP before PiCG (£)	On-the-road RRP after PiCG (£)	Financial Year 2022/23 BiK 20% (£)	WLTP Combined CO ₂ (g/km) – pack code	Insurance groups
GS Line									
Electric Propulsion (136PS) auto	AT48 9JQ1	23,166.67	4,633.33	27,800.00	28,555.00	27,055.00	9.48	0	24E
Ultimate									
Electric Propulsion (136PS) auto	AU48 9JQ1	25,337.50	5,067.50	30,405.00	31,160.00	29,660.00	10.37	0	tba

WLTP Combined CO₂ (g/km) figures are based on a configured vehicle as per pack code for UK with no options fitted.

Please note: On-the-road recommended retail prices (RRP) include number plates and delivery to Retailer of £700.00 (inc. £116.67 VAT), 12 months' Vehicle Excise Duty and new vehicle first registration fee of £55.00. Excludes fuel and insurance. Company Car Benefit in Kind (BiK) rates are monthly based on the standard paint price. Price has been calculated using manufacturer estimates and includes a £1,500.00 OZEV grant which has been deducted from the price of the vehicle (OZEV Grant not available in the Isle of Man). The grant is a government incentive and is subject to withdrawal prior to delivery of your vehicle. Retailers may be required to carry out more than one credit check during the course of the order process. You may be required to place a deposit when placing your order with your supplying Retailer.

Corsa-e is not covered by our Price Protection Guarantee. See 'Further Information' page for details.

Corsa Prices

	Pack Code	Fuel Type	Price (£)	VAT (£)	Total (£)	On-the-road RRP (£)	Financial Year 2022/23 BiK 20% (£)	WLTP Combined CO ₂ (g/km) [#] – pack code	Insurance groups
Design									
1.2 (75PS)	AC48 EE11	Petrol	13,662.50	2,732.50	16,395.00	17,340.00	79.77	118	tba
1.2 (100PS) Turbo	AC48 EX61	Petrol	14,412.50	2,882.50	17,295.00	18,240.00	83.97	117	tba
1.2 (100PS) Turbo auto	AC48 EK81	Petrol	15,854.17	3,170.83	19,025.00	19,970.00	95.33	121	tba
GS Line									
1.2 (75PS)	AS48 EE11	Petrol	15,454.17	3,090.83	18,545.00	19,490.00	89.80	118	tba
1.2 (100PS) Turbo	AS48 EX61	Petrol	16,204.17	3,240.83	19,445.00	20,390.00	97.37	120	tba
1.2 (130PS) Turbo auto	AS48 EL81	Petrol	18,454.17	3,690.83	22,145.00	23,090.00	110.42	123	tba
Ultimate									
1.2 (100PS) Turbo	AM48 EX61	Petrol	18,691.67	3,738.33	22,430.00	23,375.00	107.93	119	17E
1.2 (130PS) Turbo auto	AM48 EL81	Petrol	20,941.67	4,188.33	25,130.00	26,075.00	124.83	123	23E

WLTP Combined CO₂ (g/km) figures are based on a configured vehicle as per pack code for UK with no options fitted.

[#]Provisional fuel consumption and CO₂ figures are determined according to the WLTP test cycle. CO₂ figures, BiK values and RRP pricing shown above are for a standard vehicle without any additional optional equipment. CO₂ figures are used to calculate Vehicle Excise Duty (VED) for the first registration of the vehicle and BiK. The addition of optional extras could increase the certified CO₂ emission output. This in turn may affect the amount of VED payable upon registration, and, for company car drivers, the P11D value and the amount of Benefit in Kind (BiK) tax payable. Figures shown are for comparison purposes and should only be compared to the fuel consumption and CO₂ values of other cars tested to the same technical standard. The fuel consumption achieved, and CO₂ produced, in real world conditions will depend upon a number of factors including, but not limited to: the accessories fitted (pre and post registration); variations in weather; driving styles and vehicle load. The WLTP (Worldwide Harmonised Light Vehicles Test Procedure) is used to measure fuel consumption and CO₂ figures. Full data relating to WLTP test cycles can be found at: www.vauxhall.co.uk/wltp

Please note: On-the-road recommended retail prices (RRP) include number plates and delivery to Retailer of £700.00 (inc. £116.67 VAT), 12 months' Vehicle Excise Duty and new vehicle first registration fee of £55.00. Excludes fuel and insurance. Company Car Benefit in Kind (BiK) rates are monthly based on the standard paint price.

PureSense

Standard Features – The following features are standard across the entire Corsa range.
Specific features by model are outlined in the separate tabular information.

Cruise control with speed limiter

With steering wheel mounted controls. Enables you to maintain a constant speed, making it ideal for economical motorway driving.

Front camera system

A range of class-leading driver assistance and safety features are controlled by the front camera system.

Forward collision alert

The system operates automatically from 3mph and gives an audible warning as well as a visual warning when approaching another vehicle too quickly.

Automatic emergency city braking

The system works automatically in conjunction with forward collision alert, at speeds between 3mph and 53mph, and detects both vehicles and pedestrians.

Lane departure warning with lane keep assist

If the driver has not actively steered or signalled, the lane departure warning system provides gentle steering correction and warns when the car moves outside of lane markings at speeds above 40mph.

- Warning light in instrument cluster
- Facia on/off switch

Driver drowsiness alert

The system monitors driving time and driving behaviour to help prevent accidents caused by tiredness.

Speed sign recognition

Detects and then displays speed limits, reducing uncertainty and the risk of speeding.

- Recognises different speed signs, including temporary speed restrictions
- Displays reminder in the instrument cluster
- Works in conjunction with the cruise control/speed limiter to help the driver adapt to the recognised speed limit

Please note, Vauxhall driver assistance systems are intended to support the driver within the system-imminent limitations. The driver remains responsible for the driving task at all times.

Model Specific Features

	Electric models		Design	Petrol models	
	GS Line	Ultimate		GS Line	Ultimate
Driver Assistance					
Electronic parking brake	●	●	auto only	●	●
Rear parking distance sensors	●			●	
Front and rear parking distance sensors		●			●
Panoramic rear-view camera		●			●
Enhanced automatic emergency city braking		●			●
Adaptive cruise control		●			excl auto
Lane positioning assistant					excl auto

Standard Features – The following features are standard across the entire Corsa range.
 Specific features by model are outlined in the separate tabular information.

Driver Information

Instrumentation

- Speedometer and rev counter
- Fuel gauge with low fuel level warning light
- Water temperature gauge with warning light
- Shift-up indication light (manual models only)
 – indicates when to change gear for optimum fuel economy

Driver information display

(centrally located in instrument cluster)

- Service-due indicator
- Deflation detection system

Multi-function trip computer

(displayed on driver information display)

- Trip mileage
- Vehicle range based on remaining fuel
- Average speed
- Average fuel economy
- Instantaneous fuel economy

Central facia display

(format dependent on infotainment unit)

- Audio information
- Digital clock with automatic RDS time adjustment
- Outside air temperature with ice warning function
- Additional features dependent on infotainment unit (see infotainment for details)

Model Specific Features

	Electric models		Design	Petrol models	
	GS Line	Ultimate		GS Line	Ultimate
Driver Information					
3.5-inch colour instrument cluster			●		
7-inch digital colour instrument cluster	●	●		●	●

PureConnect

Standard Features

Multimedia

Standard on Design and GS Line models

Onboard features:

- 7-inch colour touchscreen
- DAB Digital radio
- RDS with Traffic Programme
- AM/FM stereo radio with 25 station presets
- Six speakers
- 20 watts per channel output

Media connections:

- USB connection with iPod control
- Bluetooth® A2DP audio streaming (Advanced Audio Distribution Profile)

Mobile phone portal:

- Bluetooth® connectivity
- Vehicle microphone
- Handsfree calls via steering wheel controls
- Phone book access – Contacts/last calls/missed calls etc. are mirrored on the display and are easily navigated using the touchscreen (features dependent on mobile phone)

Smartphone interface:

- Apple CarPlay
- Android Auto™
- Smartphone projection that allows operations via voice command, touchscreen and buttons to control apps and music playback

Additional features:

- Steering wheel-mounted audio controls
- Flexible roof-mounted aerial

Multimedia Navi with 7-inch touchscreen

Optional on Design and GS Line models at £500 including VAT

Standard on Corsa-e GS Line models

Features as Multimedia, with the addition of navigation features:

Onboard features:

- 7-inch colour touchscreen

Navigation features:

- Satellite navigation system
- 2D/3D street level mapping
- European coverage
- Points-of-interest search
- Map updates via USB

Multimedia Navi Pro with 10-inch touchscreen

Standard on Ultimate models

Standard on Corsa-e Ultimate models

Onboard features:

- 10-inch colour touchscreen

Navigation features:

- Satellite navigation system
- 2D/3D street level mapping
- European coverage
- Points-of-interest search
- Map updates via USB



Please note that compatibility and certain functions may be different depending on the type of device and operating system you're using with the Multimedia systems. Apple CarPlay is a trademark of Apple Inc. Apple and iPhone are trademarks of Apple Inc., registered in the U.S. and other countries. Android is a trademark of Google Inc, also registered in the U.S. and other countries. *Services may require a subscription/fee and are subject to mobile network coverage and availability. Standard on Nav models only. Live navigation services are included for 3 years and thereafter are subject to an additional subscription fee.

Please note, Apple CarPlay screen illustrated on 10-inch colour touchscreen.

Standard Features – Vauxhall Connect* is the new way to stay connected while on the road. Smart technology systems and related services keep our drivers safe and provide an exciting, efficient yet safe trip. Activating Vauxhall Connected Services is easy, just visit Vauxhall Connect Store or download MyVauxhall app.

Peace of mind

- Emergency call (SOS e-call)
- Breakdown call (b-call)
- Vehicle status and information**
- Maintenance alerts, fuel level, average fuel consumption and mileage



Vauxhall SOS

In the event of a breakdown or accident, you can count on Vauxhall Connect as your car has its own SIM card installed. If something happens that means there may have been an accident – say, the airbags are inflated or the pre-tensioners on the seatbelts are activated – an automatic message will go off to the emergency services, with details of your location. Vauxhall Connect SOS can be activated manually too – just press the button and you'll be put straight through to the emergency services on the system's integrated phone. So, if you have an accident, or see one, it only takes a few seconds to call for help.

Got a problem with your car but don't need the emergency services? Just press the Vauxhall Connect Assistance button and you'll be connected to our control centre over the system's integrated phone.

Convenience

- E-remote control (Corsa-e only)**
- Remote check of battery level, programming and charge management
- Pre-conditioning of vehicle temperature



E-remote

Check and manage your electric/hybrid vehicle range remotely and in real time using your smartphone. With MyVauxhall you can check the charge and range of your vehicle at any time, and if you're plugged into a charging point, you're even able to control charging when you're far away. To offer peace of mind, you can be alerted when the battery is full or the charging is interrupted.

The remote pre-conditioning feature allows you to warm or cool the vehicle to an optimal temperature before starting your journey. With your comfort in mind, this feature allows you to maximise range if your vehicle is on charge, by taking energy from the source, rather than the battery.

This service is supplied free of charge by Vauxhall for the life of the vehicle.

Drive Smart

- Live navigation[†] (subscription included for three years) with on-line traffic, fuel prices and parking information, Points Of Interest (POI) search and weather
- Trip and drive management**
- Timestamping of trips, trip details, last vehicle position, guide-to-car and more



Live Navigation Plus[†]

Vauxhall's fully integrated navigation system helps you stay informed, providing real-time information from the leading European GPS provider, TomTom[®]. It can be operated using natural voice recognition, meaning your eyes need never leave the road.

Vauxhall Live Navigation Plus is included free of charge for three years and can then be renewed at a cost.

- TomTom[®] services
- Real time traffic news
- Parking prices and availability
- Weather forecast on your journey
- Natural voice control
- Fuel prices at petrol stations
- Search for charging stations
- Quick search for addresses and points of interest
- Road safety alerts

Comfort and Convenience

Standard Features – The following features are standard across the entire Corsa range.
Specific features by model are outlined in the separate tabular information.

Interior Convenience

- 12-volt electrical accessory socket
- Driver's and front passenger's sunvisors incorporating vanity mirrors with covers
- Illuminated glovebox with lid
- Interior courtesy light and front map reading lights
- Luggage compartment lighting
- Two-litre open door pockets

Heating and Ventilation

- Cabin particulate filter – removes dust, airborne particles and pollen
- Four-speed fan with illuminated controls
- Four adjustable facia vents
- Windscreen and side window demist vents

Model Specific Features/Option

	Electric models		Design	Petrol models	
	GS Line	Ultimate		GS Line	Ultimate
Interior Convenience					
Rain-sensitive windscreen wipers	●	●		●	●
Automatic anti-dazzle rear-view mirror	●	●		●	●
Paddle shift			auto only	auto only	auto only
Front centre armrest with storage	●	●		●	●
Heating and Ventilation					
Air conditioning with air recirculation facility			●		
Electronic climate control	●	●		●	●
Heated front seats/Heated steering wheel	£350*	●		£350**	●†

*Optional at extra cost including VAT. **Optional at extra cost including VAT. Excluding auto models. †Heated steering wheel standard on manual models only.

Standard Features – The following features are standard across the entire Corsa range.
 Specific features by model are outlined in the separate tabular information.

Exterior Convenience

- Solar heat-absorbing windscreen
- Two-speed windscreen wipers with variable intermittent wipe
- Electrically operated front and rear windows with safety autoreverse and one-touch facility
- Glazed tailgate with heated window and wash/wipe facility
- Twin electrically adjustable/heated door mirrors

Model Specific Features/Option

	Electric models		Design	Electric models	
	GS Line	Ultimate		GS Line	Ultimate
Exterior Convenience					
Fixed panoramic glass sunroof	£500*	£500*		£500*	£500*
Remote control security alarm system	●	●		●	●
Keyless start	●				
Keyless entry and start		●			●
Electrically folding door mirrors		●			●

*Optional at extra cost including VAT.

Design



Steering wheel:

- Three-spoke design
- Flat-bottomed
- Leather-covered
- Satin chrome-effect bezel

Facia and door trim:

- Mistral facia
- Jet Black door panels
- Chrome-effect interior door handles

Seat trim:

- Fresez Marvel Black fabric seat trim inserts
- Mistral fabric side bolsters and surrounds

Seating:

- Comfort front seats
- Driver's seat (six-way adjustable):
 - Height (up/down)
 - Reach (fore/aft)
 - Backrest (upright/recline)
- Front passenger's seat (four-way adjustable):
 - Reach (fore/aft)
 - Backrest (upright/recline)
- 60/40 split folding rear seats

GS Line



Steering wheel:

- Three-spoke design
- Flat-bottomed
- Leather-covered
- Satin chrome-effect bezel

Facia and door trim:

- Liquid Palladium facia with Hot Red accents
- Liquid Palladium cloth inserts
- Chrome-effect interior door handles

Seat trim:

- Banda Marvel Black fabric seat trim inserts
- Mistral fabric side bolsters and surrounds
- Signal Red and Dark Titanium seat stitching

Seating:

- Sports-style front seats
- Driver's seat (six-way adjustable):
 - Height (up/down)
 - Reach (fore/aft)
 - Backrest (upright/recline)
- Front passenger's seat (four-way adjustable):
 - Reach (fore/aft)
 - Backrest (upright/recline)
- 60/40 split folding rear seats

Ultimate



Steering wheel:

- Three-spoke design
- Flat-bottomed
- Leather-covered
- Satin chrome-effect bezel

Facia and door trim:

- Jet Black facia with Galvano Chrome inserts
- Jet Black door panels
- Chrome-effect interior door handles

Seat trim:

- Alcantara seat trim inserts
- Jet black side bolsters and surrounds

Seating:

- Driver's seat with massage function (six-way adjustable):
 - Height (up/down)
 - Reach (fore/aft)
 - Backrest (upright/recline)
- Front passenger's seat (six-way manual adjustable):
 - Height (up/down)
 - Reach (fore/aft)
 - Backrest (upright/recline)
- 60/40 split folding rear seats

Safety and Security

Standard Features – The following features are standard across the entire Corsa range.

Airbags

- Driver’s airbag
- Front passenger’s airbag
- Front seat side-impact airbags
- Full-size curtain airbags

Seatbelts

- Inertia-reel lap and diagonal seatbelts
- ‘Seatbelt unfastened’ audible warning and warning light

Braking

- Hill start assist

Child safety

- Deactivation switch for front passenger’s airbag
- ISOFIX child seat mountings incorporating top tether anchor points located on outer rear seats (does not include child seat)
- Child-proof locks on rear doors

Pedestrian safety

- Bonnet/headlight/wiper structure – Designed to reduce pedestrian head and upper body injuries
- Upper and lower bumper design – Reduces upper and lower leg injuries

Tyre pressure

- Tyre pressure monitoring system

Security

- Electronically protected audio equipment
- Engine deadlock immobiliser
- Visible Vehicle Identification Number (VIN)
- Locking wheel bolts for alloy wheels
- Freewheeling door locks

Remote control central locking

- Operates on doors, tailgate and fuel filler flap
- Deadlocking
- Central locking activation switch on driver’s door

Model Specific Feature

	Electric models		Design	GS Line		Ultimate
	GS Line	Ultimate		GS Line	Ultimate	
Security						
Remote control security system	●	●		●	●	



Hill start assist.



ISOFIX child seat mountings.

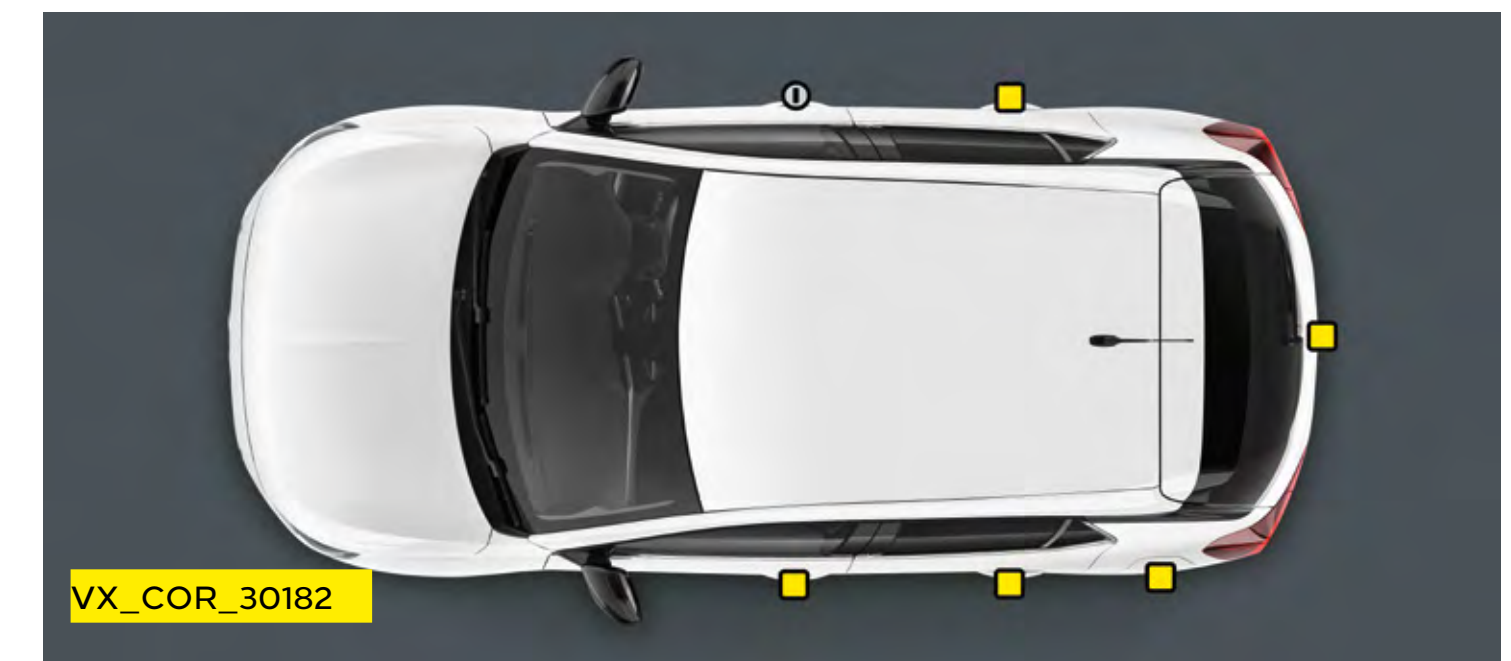

Remote control central locking.

Lighting

Standard Features – The following features are standard across the entire Corsa range.
Specific features by model are outlined in the separate tabular information.

Exterior Lighting

- LED headlights
- High beam assist
- Lights-on audible warning
- LED daytime running lights

- Headlight levelling system
- Rear fog lights
- Centre rear brake light
- Hazard warning lights
- Rear reversing light

Interior Lighting

- Central front courtesy light
- Central rear courtesy lights
- Fade up/fade down

Model Specific Features

	Electric models		Design	GS Line	Ultimate
	GS Line	Ultimate			
Exterior Lighting					
Automatic lighting control	●	●		●	●
LED tail lights	●	●		●	●
LED front fog lights	●	●		●	●
Automatic headlight levelling system		●			●
IntelliLux LED® Matrix headlights		●			●
Interior Lighting					
LED ambient lighting		●			●



VX_COR_31775

LED headlight.



VX_COR_31713

LED tail lights.



VX_COR_e_31509

IntelliLux adaptive LED® Matrix headlights.

Styling

Standard Features – The following features are standard across the entire Corsa range.
Specific features by model are outlined in the separate tabular information.

Exterior Styling

- Body-colour front and rear bumpers
- Body-colour door handles and mirror housings
- Chrome logo bar

Model Specific Features/Option

	Electric models				
	GS Line	Ultimate	Design	GS Line	Ultimate
Exterior Styling					
Black roof and A-pillars	●	●		●	●
Body-colour roof and A-pillars	No-cost	No-cost	●	No-cost	No-cost
Black lower side window mouldings	●		●	●	
Chrome-effect lower side window trim		●			●
Sports front and rear body styling	●	●		●	●
High gloss black B-pillars	●	●		●	●
Chrome-effect exhaust tailpipe extension				●	●
Dark-tinted rear side and tailgate windows	●	●		●	●
Interior Styling					
Alloy-effect sports pedals	●			●	●
Black headliner	●			●	●

Exterior Colours

Jade White (G2o)*
Brilliant paint



VX_COR_30169

Diamond Black (G7o)**
Two-coat metallic paint **£600**



VX_COR_30168

Quartz Grey (G4i)***
Two-coat metallic paint **£600**



VX_COR_30165

Crystal Silver (GAU)****
Two-coat metallic paint **£600**



VX_COR_33200

Voltaic Blue (G6L)**
Two-coat metallic paint **£600**



VX_COR_30167

Power Orange (GPQ)**
Two-coat premium metallic paint **£700**



VX_COR_30170

Hot Red (G1R)**
Two-coat premium metallic paint **£700**







VX_COR_30163

The colours reproduced may vary slightly from the actual paint colour. As a result they should be used as a guide only. Your Vauxhall Retailer has a comprehensive display of our paint samples.

*Standard exterior paint. **Optional at extra cost including VAT. †GS Line and Ultimate models only. ††Design models only.

Wheels and Tyres

		Electric models				
		GS Line	Ultimate	Design	GS Line	Ultimate
	16-inch silver 8-spoke alloy wheels • 195/55 R 16 tyres. • Emergency tyre inflation kit (in lieu of spare wheel)			●		
	17-inch black alloy wheels • 205/45 R 17 tyres. • Emergency tyre inflation kit (in lieu of spare wheel)				●	
	17-inch diamond-cut bi-colour alloy wheels • 205/45 R 17 tyres. • Emergency tyre inflation kit (in lieu of spare wheel)				£150*	●
	17-inch bi-colour alloy wheels • 205/45 R 17 tyres. • Emergency tyre inflation kit (in lieu of spare wheel)	●	●			
Provision for spare wheel fitment (spare wheel is Retailer-fit)				£20*	£20*	£20*

*Optional at extra cost including VAT. Not available on Corsa-e electric models.

Corsa-e Specifications

Single-speed electronic drive selector

As the motor is an all-electric single-speed drive unit, there is no need for multiple gears. Instead, the shifter lets the driver select from the following:

- Park
- Reverse
- Neutral
- Drive
- Braking (for increased regenerative braking)

Drive Mode Selector

The driver can determine the driving style through selecting one of the following modes:

- **Sport:** for a dynamic drive with a responsive throttle and the highest top speed and torque
- **Normal:** for a balanced drive that offers a compromise between performance and energy efficiency
- **ECO:** for maximum range and energy efficiency. The ECO mode deactivates all unnecessary energy-consuming features and reduces the top speed, torque and overall performance

Drivetrain	Corsa-e
CO ₂ emissions	0g/km
Maximum power	100/136kW/PS
Maximum torque	260/192Nm/lb. ft.
Acceleration 0-60mph	7.6 sec
Maximum speed	93mph
Transmission	Automatic electric drive with fixed gear ratio
Kerbweight	1530kg
Service interval	Initial inspection at 8,000 miles/1 year (whichever comes sooner). Thereafter 16,000 miles/2 years (whichever comes sooner)

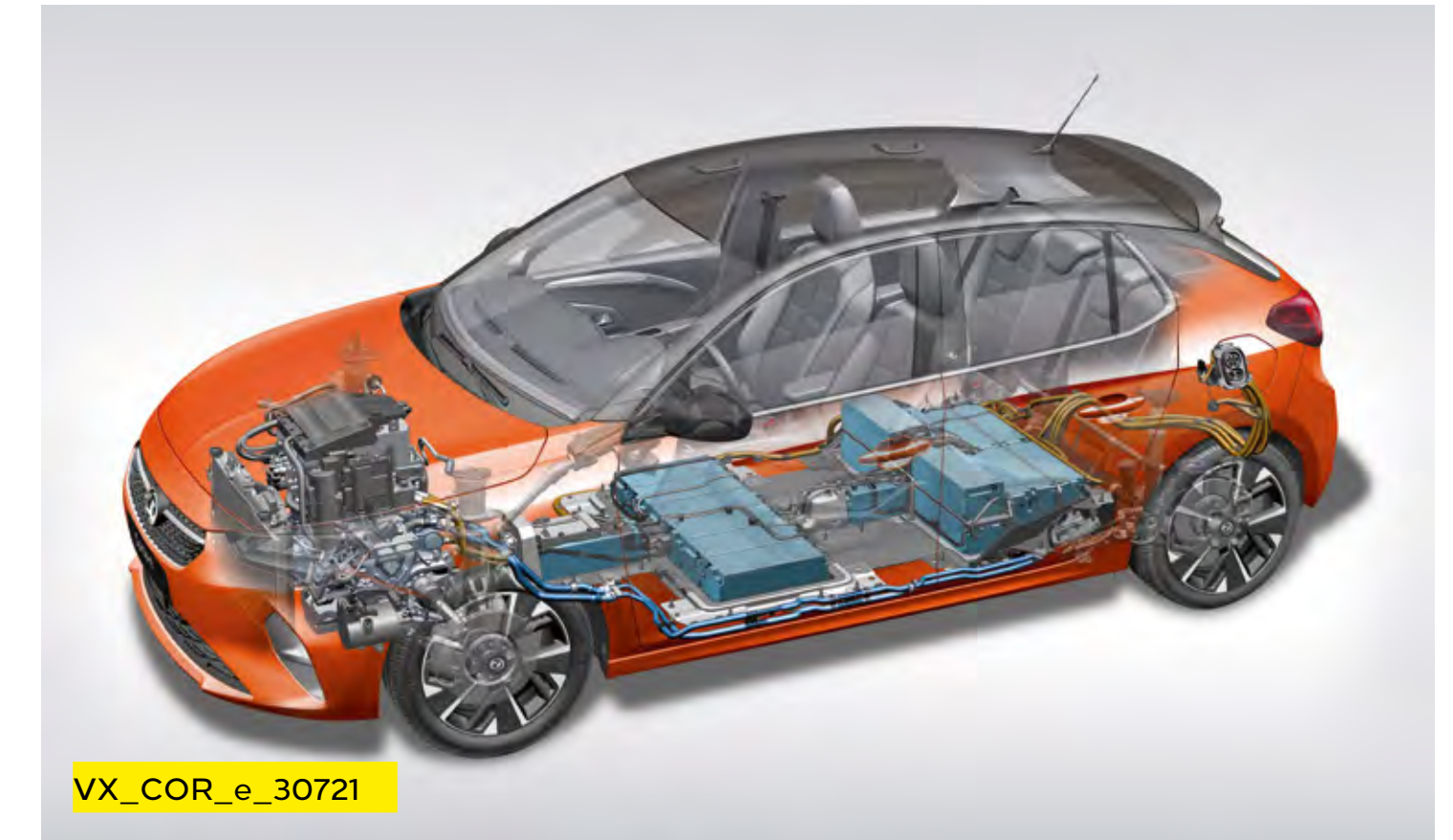

Corsa-e Specifications

Charging

Corsa-e is fitted with a 11kW on board charger and is also equipped with a Mode 3 cable as standard as shown below. Additional charging accessories are available at extra cost, see Accessories page for more details or consult your local Retailer.

	11kW on-board charger
Mode 3, 3-phase 22kW cable	Standard
Mode 2, emergency charging cable	Optional accessory £584

The charging flap's Padlock LED lights up when the cable is correctly plugged in and locked and then acts as a user interface to show the charging status via coloured LED lights:

- **White:** welcome light that helps to light up the area, especially useful in dark conditions
- **Flashing green:** charging in progress
- **Solid green:** charging complete
- **Solid blue:** delayed charging toggled; changes to flashing green when charging commences
- **Solid red:** malfunction

The driver may also choose from two settings:

- **Immediate charging (the standard setting):** Starts charging as soon as the vehicle is docked for charging
- **Delayed charging:** This is especially useful for when cheaper electric rates are desired, e.g. charging at night. Simply enter a charging start time

Please note, EV range assumes that vehicle has been pre-conditioned prior to journey. This function can be accessed either via MyVauxhall App (standard with all Corsa-e) or by using the Multimedia Navi Pro infotainment system (standard on Ultimate).

Charging		
Supply	Socket	Charge Time (0-100%)
AC current - Domestic 3 pin socket (2.3kW)	Type 2	21h 45m
AC current - Home wallbox or public charger (7kW)	Type 2	7h 30m
AC current - Public charger (11kW)	Type 2	5h
DC current - Rapid charger (100kW)	CCS	30m (0-80%)

Battery	
Battery capacity	50kWh
AC on-board charger speed	11kW
EV range (WLTP high)*	222 miles
Energy consumption (Combined low/high)	16.5-16.8kWh/100km
Battery warranty	8 years/100,000 miles/70% capacity



The Corsa-e is a battery electric vehicle requiring mains electricity for charging. Range data given has been determined according to WLTP test procedure methodology. The figures shown are intended for comparability purposes only and should only be compared to other cars tested to the same technical standard. The range you achieve under real world driving conditions will depend upon a number of factors, including but not limited to: the accessories fitted (pre and post registration); charging frequency; personal driving style; vehicle load and route characteristics; variations in weather; heating/air conditioning; pre-conditioning and battery condition. For more information, contact your local Vauxhall Retailer.

*WLTP preliminary.

Petrol Engines

	1.2 (75PS)	1.2 (100PS) Turbo	1.2 (130PS) Turbo automatic
Capacity	1199cc	1199cc	1199cc
Maximum power	75PS (55kW) @ 5750rpm	100PS (74kW) @ 5500rpm	130PS (96kW) @ 5500rpm
Maximum torque	118Nm (87lb.ft.) @ 2750rpm	205Nm (151lb.ft.) @ 1750rpm	230Nm (169lb.ft.) @1750rpm
Configuration	3 cylinders, 4 valves per cylinder, double overhead camshafts	3 cylinders, 4 valves per cylinder, double overhead camshafts	3 cylinders, 4 valves per cylinder, double overhead camshafts
Fuel/induction system	Naturally aspirated with Variable Valve Timing. Multi-point sequential fuel injection	Turbocharger. Multi-point sequential fuel injection	Turbocharger. Multi-point sequential fuel injection
Emission compliance	Euro 6d	Euro 6d	Euro 6d
Service interval	12,500 miles or 1 year (whichever occurs sooner)	12,500 miles or 1 year (whichever occurs sooner)	12,500 miles or 1 year (whichever occurs sooner)

Specifications

Transmission

- Front-wheel drive
- Five-speed manual gearbox
 - Available on 1.2 (75PS) models.
- Six-speed manual gearbox
 - Available on 1.2 (100PS) Turbo models.
- Eight-speed automatic transmission
 - Available on 1.2 (100PS) Turbo /1.2 (130PS) Turbo models.

Steering

- Speed-sensitive power-assisted steering

Brakes

- Electronic Stability Programme (ESP)
- Traction control
- Drag torque control
- Anti-lock Braking System (ABS)
- Electronic brakeforce distribution
- Emergency brake assist
- Cornering brake control
- Straight line stability control

1.2 (75PS)

Front ventilated discs: 356mm diameter
Rear drums: 203mm diameter

1.2 (100PS)/1.2 (130PS)

Front ventilated discs: 381mm diameter
Rear discs: 356mm diameter

Fuel tank capacity

- 1.2 (75PS) 40 litres
- 1.2 (100PS) Turbo/1.2 (130PS) Turbo 44 litres

Start/Stop technology

Corsa's Start/Stop system offers real benefits by improving fuel economy and reducing CO₂ emissions, particularly in town. It does this by automatically stopping the engine when you come to a standstill, and then restarting as you prepare to move off.

Before automatically stopping the engine a number of system checks are carried out to ensure that it is both safe and practical to do so. To ensure safety, the driver must depress the clutch pedal, shift in to neutral, and then release the clutch pedal.

System checks carried out before Auto Stop activates include:

- Start/Stop system is not manually deactivated via the facia button
- Sufficient brake vacuum is available to prevent the car rolling down an incline
- Battery is in good condition and charged
- Outside air temperature and engine temperature are above specified minima
- Electronic climate control (where fitted) is not in maximum heating or maximum cooling mode

If all of these conditions are satisfied then the vehicle will Auto Stop.

When you are ready to pull away from standstill, Auto Restart is activated by depressing the clutch pedal.

Whilst at a standstill the vehicle is continually monitored. If necessary, the engine will automatically be restarted. Conditions that would initiate an Auto Restart include:

- Low battery level
- Brake vacuum below specified minimum
- Start/Stop system is manually deactivated
- Stationary for 5.5 minutes

Performance, Fuel Economy and Emissions

	Performance (manufacturer's figures)		Fuel economy mpg (litres/100km) [#]		CO ₂ emissions g/km [#]		Vehicle Excise Duty*		BiK rates from - 2022/23 tax year
	Maximum speed (mph)	Acceleration 0-60mph (sec)	Combined Low	Combined High	Combined Low	Combined High	First year rate	Standard rate	
1.2 (75PS)	108	12.4	47.9 (5.9)	53.3 (5.3)	118	133	£190	£165	28%
1.2 (100PS) Turbo	121	9.3	47.9 (5.9)	52.3 (5.4)	117	134	£190	£165	28%
1.2 (100PS) Turbo automatic	119	10.2	45.7 (6.2)	48.7 (5.8)	121	140	£190	£165	29%
1.2 (130PS) Turbo automatic	129	8.2	47.1 (6.0)	50.4 (5.6)	123	136	£190	£165	29%

Weights and Towing Data^{kg}

	Gross vehicle weight	Maximum towing weights Trailer with brakes (without brakes)
1.2 (75PS)	1550	500 (500)
1.2 (100PS) Turbo	1620	1200 (580)
1.2 (100PS) Turbo automatic	1645	1200 (580)
1.2 (130PS) Turbo automatic	1650	1200 (580)

[#]Figures shown are for comparison purposes and should only be compared to the fuel consumption and CO₂ values of other cars tested to the same technical standard. The fuel consumption achieved, and CO₂ produced, in real world conditions will depend upon a number of factors including, but not limited to: the accessories fitted (pre and post registration); variations in weather; driving styles and vehicle load. The WLTP (Worldwide Harmonised Light Vehicles Test Procedure) is used to measure fuel consumption and CO₂ figures. The CO₂ figures display a range to reflect the highest value for the highest emitting version with all available options added, through to a minimum value to represent the lowest emitting version in standard specification. *Correct at time of publication.

Please note: Gross vehicle weight is the total permissible weight of the vehicle including passengers and their luggage. The maximum roof rack loading should not exceed 70kg. The maximum towing weights are based on the ability of the car, with two occupants of 75kg each, to restart on a 12% gradient, which is approximately 1 in 8.3, at sea level. The permitted trailer load applies up to the specified incline and up to an altitude of 1000 metres above sea level. The permissible gross train weight decreases by 10% for every 1000 metres of additional altitude. At altitudes above 1500 metres, the engine output may drop with a corresponding reduction in towing capability. Any extra weight, such as luggage or additional passengers, should be deducted from the maximum towing weight. With a trailer fully loaded, maximum noseweight should not exceed 55kg. Always fit Vauxhall towing attachments and accessories available from your Vauxhall Retailer. They are designed specifically for Vauxhall models and carry a 12-month guarantee. During trailer towing do not exceed a maximum speed of 60mph. This speed limit is also applicable in countries with higher permitted speeds for trailer-vehicle combinations. Pay attention to the local speed limits. For trailers with low driving stability and caravans the use of an oscillation damper is strongly recommended.

Dimensions and Capacities All measurements in mm (inches) unless stated otherwise.

VX_COR_31767



VX_COR_30093

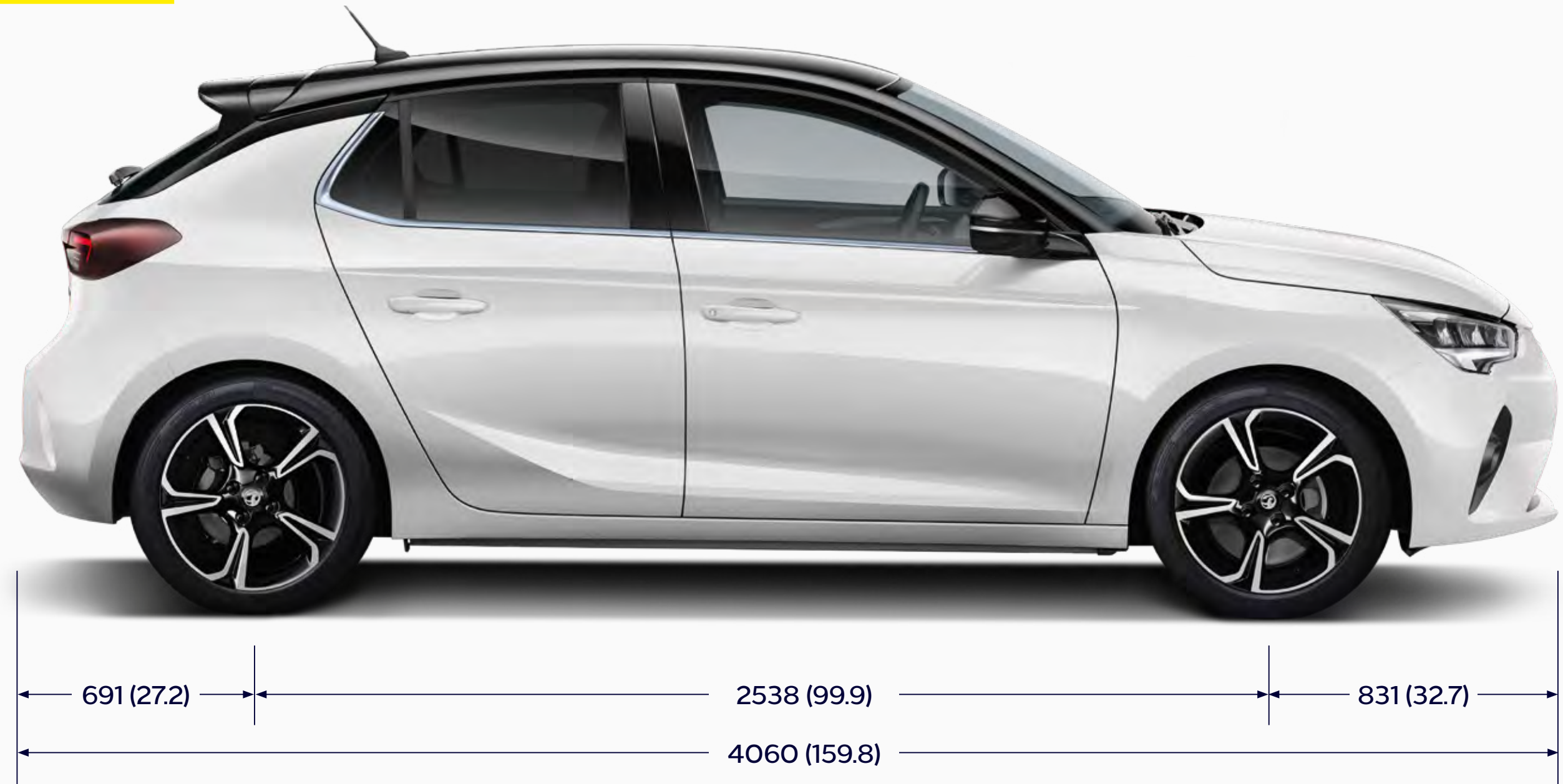

Loadspace Dimensions	Corsa	Corsa-e
Maximum length behind rear seats	885 (34.8)	885 (34.8)
Maximum length rear seats folded	1697 (66.8)	1697 (66.8)
Maximum width	867 (34.1)	867 (34.1)
Maximum height	574 (22.5)	574 (22.5)

Luggage Capacities Litres (cu.ft.)	Corsa	Corsa-e
Rear seats up (under luggage compartment cover)	309 (10.9)	267 (9.4)
Rear seats folded (to roof)	1118 (39.4)	1081 (38.1)

Accessories

Safety	Total (inc. VAT)	Protection	Total (inc. VAT)	Style	Total (inc. VAT)	Transport solutions	Total (inc. VAT)
Spare wheel kit with 15-inch emergency wheel and tool kit (petrol models only) ¹	£167	Floor mats (set of 4)		Decal kit with roof and bonnet racing stripes, in black or white	£217	Towing	
Philips ADR620 dash cam	£109	- Carpet	£33	Sport pedal covers		Tow bar with removable tow ball and 13-track wiring loom ^{3,4}	£655
Front parking sensors	£390	- Rubber	£53	- Manual	£63	Towbar socket adapter ³ – 13 to 7 pin	£30
Rear parking sensors	£407	- Velour	£77	- Auto	£44		
Rear view camera kit	£760	Rear seat cover	£40	Body styling kit ⁴ with front and rear bumper attachments, and side skirts	£1,350	Electric	
Child seats ²		Boot area cover	£54	17-inch diamond-cut bi-colour alloy wheels (set of four) ³	£1,220	Mode 2 emergency charging cable (Type G – UK domestic plug)	£584
- Group 0 (0-13kg) – Britax Romer Baby Safe	£239	Rubber boot tray	£50	Centre caps		- 7.4kW	£331
- ISOFIX Base, Rear-facing for Britax Romer Baby Safe	£251	Reversible boot liner (carpet/rubber)	£82	- Hot Red or Voltaic Blue	£23	- 11kW	£371
- Group 2/3 (15-36kg) – Britax Romer KIDFIX 2 R	£317	Rear bumper protection film	£37	- Gloss Black	£12	- 22kW	£438
- Group 2/3 (15-36kg) – Britax Romer KIDFIX XP	£352	Front and rear splash guards ⁴	£84	Valve caps (set of 4)		Cable bag	£49
- Group 3 (22-36kg) – Booster Seat without Seatback	£76			- Chrome with Vauxhall logo	£10	Mode 2 Universal Charger UK kit (22kW)	£1,555
Safety Pack – first aid kit, hi-vis vest and warning triangle	£16	Comfort		Available in Gloss Black, Summit White, Hot Red, Voltaic Blue or Carbon fibre-effect:		Accessories for Universal Charger	
Warning triangle	£9	USB charger – 2 front and 2 rear ports	£28	- Exterior door mirror covers ⁵	£111	- Wall bracket	£105
Hi-vis safety vest – adult	£4	FlexConnect bracket	£20	- Grille bar	£172	- Bag	£65
Hi-vis safety vest – child 3-6 years (42cm)	£4	FlexConnect hook	£37	Wheel inserts ^{6,7}		- Safety lock	£20
Hi-vis safety vest – child 7-12 years (52cm)	£4	FlexConnect coat hanger	£41	- Each	£20	- Adapter Type 2	£318
First aid kit	£15	FlexConnect folding table	£102	- Set of four	£32-36	- Adapter Type 3c	£358
Emergency seat belt cutter and hammer	£19	FlexConnect iPad Mini holder	£127	- Interior rear-view mirror covers ^{3,5,6}	£64	- Adapter (various)	£120
Fire extinguisher (1kg) with strap	£23	FlexConnect iPad holder	£106	- Interior facia inserts ⁶	£178		
Under seat bracket for fire extinguisher ³	£48	FlexConnect iPad Air holder	£106	- Manual gear knobs ⁸	£82		
		FlexConnect Samsung Galaxy 10.1 holder	£127				
		Privacy shades for rear and side rear windows	£166				
		Front wind deflectors	£78				
		Foldable front armrest with storage	£149				
		Rear cup holder	£56				
		Cupholder organisers	£8-10				
		Smoker's pack	£53				
		Fragrance diffuser	£24				
		Fragrance cartridge (various)	£18				
		Wireless phone charger	£171				

Please note: Prices shown are fully fitted and painted, where applicable and include VAT. Please check with your local Vauxhall Retailer for details. It is advisable to ensure your insurance policy is adequate to cover additional fitted accessories. Prices correct at time of publication.

¹Vehicle must be ordered with spare wheel fixing option (T7Y) in order to accommodate the spare wheel. ²Restrictions apply to the use of child seats, please consult your vehicle user manual or Vauxhall Retailer. ³Available on petrol models only. ⁴Not available on GS Line/Ultimate models.

⁵Not available in Gloss Black. ⁶Not available in Carbon fibre-effect. ⁷Only available with 17-inch diamond-cut bi-colour alloy wheels. ⁸Available in red and blue only.

Company Car Driver and Fleet Information

Benefit in kind company car taxation*

The car benefit charge will be the car's list price (including VAT, options and accessories fitted, delivery to Retailer and number plates, but excluding Vehicle Excise Duty and new vehicle first registration fee) multiplied by the percentage charge for the CO₂ emissions band in which the car falls (see table opposite). Multiply this figure by your personal income tax rate (20%** for Basic Rate, 40%** for Higher Rate) to calculate your annual benefit in kind tax liability.

Generic example:

ELECTRIC vehicle: 0g/km CO₂

On-the-road RRP	£27,305.00
Deduct: Vehicle Excise Duty	£0.00
New vehicle first registration fee	-£55.00
Effective list price	£27,250.00
Add: Optional two-coat metallic paint	£600.00
List price for tax purposes (P11D value)	£27,850.00
Car benefit charge 2022-23 tax year (2%)	£557.00
Benefit in kind tax liability	
Basic Rate (20%) tax payer	£111.40
Higher Rate (40%) tax payer	£222.80

*Please note this Price Guide provides taxation information as a guide only. Vauxhall does not provide taxation guidance. Drivers should always take professional advice on their own tax position.
 **Excludes residents of Scotland.

BiK for Scottish Residents

Effective 6 April 2018 the Scottish Government have introduced their own BiK taxation structure. This only applies to Company Car Drivers that are Scottish taxpayers. HMRC will determine whether or not an individual is a Scottish taxpayer based on where their main place of residence is.

The BiK rates for Scotland are:

- Over £12,570 - £14,732 Starter Rate 19%
- Over £14,732 - £25,688 Basic Rate 20%
- Over £25,688 - £43,662 Intermediate Rate 21%
- Over £43,662 - £150,000 Higher Rate 41%
- Above £150,000 Top Rate 46%

CO ₂ emissions (g/km)	Percentage of cars price to be taxed 2022-23 tax year
Up to 50	14%
51 - 54	15%
55 - 59	16%
60 - 64	17%
65 - 69	18%
70 - 74	19%
75 - 79	20%
80 - 84	21%
85 - 89	22%
90 - 94	23%
95 - 99	24%
100 - 104	25%
105 - 109	26%
110 - 114	27%
115 - 119	28%
120 - 124	29%
125 - 129	30%
130 - 134	31%
135 - 139	32%
140 - 144	33%
145 - 149	34%
150 - 154	35%
155 - 159	36%
160 - 164	37%
165 - 169	37%
170+	37%

CO ₂ emissions (g/km)	Electric range (miles)	Percentage of cars price to be taxed 2022-23 tax year
0	-	2%
1 - 50	130+	2%
1 - 50	70 - 129	5%
1 - 50	40 - 69	8%
1 - 50	30 - 39	12%
1 - 50	<30	14%

To calculate your own personal liability, search: **Vauxhall BiK**, or click the link below:
[Vauxhall BiK Tool](#)

Fleet Toolbox

Discover the facts in our online Toolbox for both Company Car Drivers and Fleet Decision Makers. The Fleet Toolbox has a host of useful calculators, comparators, interactive listings and information.

Search Vauxhall Fleet Tools or click the link below:
[Vauxhall Fleet Tool Box](#)

Contact Vauxhall Fleet

Please contact one of our dedicated sales teams who will be happy to help with your particular enquiry.

Company Car Drivers

Call: 0345 111 2020

Email: company-car@vauxhallinfo.co.uk

Telephone lines are open

- Monday to Friday 8:00am-9:00pm

- Saturday and Sunday 9:00am-6:00pm

Fleet Decision Makers

Depending on the size of your fleet of vehicles, we have a dedicated team to handle your enquiries. The lines are open Monday to Friday excluding Bank Holidays.

1-24 vehicles

Call: 0845 076 2254 (8:30am-5:00pm)

25+ vehicles

Call: 0330 587 8222 (8:30am-5:00pm)

Email: vauxhallfleet@vauxhall.co.uk

Special Vehicles (Police, Fire and Ambulance)

Call: 01582 409999 (8:30am-5:00pm)

Email: vauxhallspecialvehicles@vauxhall.co.uk

For more information visit vauxhall.co.uk/fleet

Further Information

On-the-road prices

To eliminate uncertainty about hidden costs when buying a new car, Vauxhall publishes on-the-road recommended retail prices (RRP) and these are shown in the pricing tables within this price guide. These prices include VAT, number plates and delivery to Retailer of £700.00 (including £116.67 VAT), 12 months' Government Vehicle Excise Duty (see opposite for details) and the DVLA new vehicle first registration fee of £55.00.*

Please note: The on-the-road recommended retail price (RRP) does not include fuel supplied by the Retailer, motor insurance or any other goods or services supplied by agreement between the Retailer and the customer.

Price protection

Order a new Vauxhall for build in the current model year (as confirmed by your Retailer) for delivery no more than three months in advance and the price you are quoted is the price you pay. This is irrespective of any subsequent price rises between placing your order and delivery of your new car, but you must take delivery as soon as the car is available.

Please note: Price protection does not apply to electric models. Vauxhall Motors Limited is not liable for price adjustments caused by Government changes in the rate of VAT (currently 20%), Vehicle Excise Duty, DVLA new vehicle first registration fee or by any other applicable legislation or regulations.

In the event of an accident

Vauxhall Accident Management helps keep you mobile following an accident. Benefits include vehicle recovery, Vauxhall-approved repairs and contacting your insurer. For more details, visit vauxhall.co.uk/AccidentManagement

Free2Move Lease

Whether you're a big company or a small business looking for vehicle financing, Free2Move Lease, our business finance specialists, can deliver exactly what you need.

Free2Move Lease is one of the UK's largest leasing companies and is also a member of the British Vehicle Rental and Leasing Association (BVRLA).

With over 60,000 vehicles in the Free2Move Lease portfolio, Free2Move Lease is able to offer competitive vehicle solutions. In addition, Free2Move Lease also offer innovative connected management of servicing and maintenance.

For further information, please contact your local Vauxhall Retailer or visit vauxhall.co.uk/offers-finance/business-leasing.html

Vehicle Excise Duty

The amount of Vehicle Excise Duty (road fund licence) payable on new cars varies depending on the level of carbon dioxide (CO₂) emissions produced by the vehicle. CO₂ emissions are measured in grams per kilometre (g/km) travelled and divided into 13 charging bands shown in the table opposite.

A 'first year rate' of Vehicle Excise Duty is payable on all new cars and in subsequent years the amount payable reverts to the 'standard rate'. From 1 April 2017 the breakpoints for each of these bands have been revised. Also, for vehicles with a list price over £40,000, including factory-fitted options, an additional £335 is payable for the first five years of standard rate payments.

Vehicle Excise Duty*

Band	CO ₂ emissions in grams per kilometre	First year rate Petrol	Standard rate Petrol	Standard rate Electric
A	0	£0	£0	£0
B	1 – 50	£10	£165	–
C	51 – 75	£25	£165	–
D	76 – 90	£120	£165	–
E	91 – 100	£150	£165	–
F	101 – 110	£170	£165	–
G	111 – 130	£190	£165	–
H	131 – 150	£230	£165	–
I	151 – 170	£585	£165	–
J	171 – 190	£945	£165	–
K	191 – 225	£1,420	£165	–
L	226 – 255	£2,015	£165	–
M	Over 255	£2,365	£165	–

*Correct at time of issue.

Further Information

Customer Care Commitment

For added peace of mind, Vauxhall has an innovative Customer Care Commitment that offers the following:

- Three-year vehicle warranty consisting of a one-year/unlimited mileage manufacturer's warranty and a second and third year manufacturer's warranty with a 60,000 miles limitation
- Vauxhall Assistance for 12 months from first registration
- Six years' body panel anti-perforation warranty

Please note: Warranty is only available on vehicles sourced from Vauxhall Motors Limited. Terms and conditions apply – please see your Vauxhall Retailer for details.

Vauxhall Assistance

Vauxhall Assistance is provided automatically with every new Vauxhall for 12 months from first registration and covers everything from accident assistance, roadside recovery and 'at home' service to flat tyres. For even more peace of mind, on Corsa-e models the cover is extended* to 8 years or 100,000 miles, whichever comes first. Even more reason for you to stay calm and let us take care of everything should the need arise. With Vauxhall Assistance help is literally just a free** phone call away, 24 hours a day, 365 days a year!

Protecting the environment

Vauxhall's commitment to the environment is demonstrated by our products' many environmental awards. For even more information on Vauxhall's efforts to achieve an environmentally sustainable future, and how to dispose of your end-of-life vehicle, see vauxhall.co.uk/recycling

Vauxhall Care

This all-inclusive service package is available on Vauxhalls under 10 months old (from date of first registration).

This package offers complete peace of mind for the first 3 years of your Vauxhall's life with fixed monthly payments for the plan duration.

- **3 years' Vauxhall servicing** – covers first, second and third annual services. Including a brake-fluid change in the second service
- **2 years' Vauxhall Roadside Assistance** – first year from us
- **First years' MOT[†]** – free of charge by your local Vauxhall Retailer

For full terms and conditions and to sign up, visit: vauxhall.co.uk/vauxhallcare

Vauxhall Service Club

Vauxhall Service Club is available for all Vauxhall owners, and it's free to join. Members benefit from the following:

- 15% off Vauxhall Approved Accessories
- Vauxhall's aged 2-3 Years = 15% off parts and labour
- Vauxhall's aged over 3 Years = 25% off parts and labour
- Half price MOT's (NI excluded)
- Free pre-MOT test inspection (NI only)
- Fixed price AdBlue[®] Refills
 - Car = £14.99
 - Van = £24.99
- Access to the Vauxhall Accident Management Programme
- Online service booking available 24/7 with servicing appointments available within 3 days – [Book Online](#)
- Collection and delivery/onward mobility options
- Complimentary 'Wash and Vac' with all routine services^{††}
- Vauxhall trained technicians
- Genuine Vauxhall parts
- Minimum 12 months warranty on parts and labour
- Regular newsletters with exclusive offers, discounts and competitions

Terms and conditions apply. To join visit: vauxhall.co.uk/serviceclub

Vauxhall Insurance with added reassurance

Comprehensive cover – Summary of benefits

- Competitive premiums
- Repairs by a Vauxhall-trained technician
- Genuine Vauxhall parts, guaranteed for five years when we repair your car within our Approved Repairer Network
- Free courtesy car as standard when using an Approved Repairer[‡]
- 24 hour claims helpline
- Personal Accident benefit
- Cover for audio equipment
- Windscreen cover

Call for a quote on **0330 678 1130^{‡‡}**

For more product information

For further information on the Vauxhall range or location of your nearest Vauxhall Retailer please call **0345 600 1500**. Alternatively, details can be found on our website at vauxhall.co.uk

For more information call **0345 600 1500**

For Fleet enquiries call **0330 587 8222**

Discover the full Vauxhall range at **[vauxhall.co.uk](https://www.vauxhall.co.uk)**

Join us online

The invoice price, including delivery to Retailer, factory-fitted options, accessories fitted by the Retailer and number plates, is subject to VAT. Some feature descriptions in this guide may refer to, and some illustrations may show, optional equipment not included in the standard delivery. The information contained in this guide was accurate at the time of publication. We reserve the right to make changes in design and equipment. Please note that Vauxhall Retailers are not the agents of Vauxhall Motors Limited and are not authorised to bind Vauxhall Motors Limited by any specific or implied undertaking or representation. It is advisable to ensure that your motor insurance policy provides adequate cover for additional fitted options and accessories. The colours in this guide are only approximate actual colours. Illustrated optional equipment is available at extra charge. Availability, technical features and equipment provided on our vehicles can vary by model. For precise information on the equipment provided on our vehicles, please contact your local Vauxhall Retailer.

VAUXHALL

Price and Specification Guide
6 April 2022 | Model Year 2022C



Corsa

Contents

To find the information you want use the links below to navigate around the guide:

[Choose Your Trim Level](#)

[Range Highlights](#)

[Models](#)

[Prices](#)

[Features/Options](#)

[Infotainment](#)

[Interior Style and Comfort](#)

[Exterior Colours](#)

[Wheels and Tyres](#)

[Engines and Technical Data](#)

[Performance, Economy and Emissions](#)

[Specifications](#)

[Dimensions and Capacities](#)

[Accessories](#)

[Company Car Information](#)

[Further Information](#)

Choose Your Trim Level

SE Edition

First in the line-up is the wonderfully well-equipped SE Edition.

Corsa-e SE Premium

Say hello to the new Corsa-e. It's 100% electric, 100% exciting.



VX_COR_33201

SRI Edition

For even more style, opt for SRI Edition. Sporty from the inside out. Relax in the sports style front seats and feel the power with the sport switch. Relax a little more with a host of premium features including heated seats and climate control.

Corsa-e SRI Premium

For even more style in your Corsa-e.



VX_COR_32592

Elite Edition

For even more features, designed to be the trim for 'comfort' and style opt for the Elite Edition.

Corsa-e Elite Premium

Step inside for a bigger touchscreen and more comfort with heated seats and steering wheel.



VX_COR_33203

Ultimate

Ultimate is the top of the range Corsa available, with top of the range equipment on the inside and out. It looks the business with all the exterior equipment including, dark-tinted rear windows and IntelliLux LED® Matrix Headlights.



VX_COR_32593

Corsa Range Highlights

SE Edition

Standard features include:

- Multimedia infotainment system
 - 7-inch colour touchscreen
 - AM/FM/DAB digital radio
 - Bluetooth®
 - Apple CarPlay/Android Auto™
 - USB connection
- Six speakers
- LED headlights
- LED daytime running lights
- High beam assist
- 16-inch silver 8-spoke alloy wheels
- Air conditioning
- Cruise control with intelligent speed limiter
- Remote control central locking
- Electrically operated front and rear windows
- Electrically adjustable/heated door mirrors
- Lane departure warning with lane keep assist
- Speed sign recognition
- Flat-bottomed leather-covered steering wheel
- Driver drowsiness alert
- Forward collision alert
- Automatic emergency city braking
- 60/40 split-folding rear seats
- Electronic parking brake (auto models only)
- Paddle shift (auto models only)

SRI Edition

Features over SE Edition models:

- 7-inch digital instrument cluster
- Sports front and rear body styling
- Alloy-effect sports pedals
- Sport switch
- Heated sports-style front seats
- Heated steering wheel (excluding auto models)
- Electronic climate control
- Front centre armrest with storage
- Electronic parking brake (all models)
- LED tail lights
- LED front fog lights
- Chrome-effect exhaust tailpipe extension
- Black roof and A-pillars
- High gloss black B-pillars
- Dark-tinted rear windows
- Rear parking distance sensors
- 17-inch diamond-cut bi-colour alloy wheels
- Remote control security alarm system
- Rain-sensitive windscreen wipers
- Automatic lighting control
- Automatic anti-dazzle rear-view mirror
- Black headliner

Elite Edition

Features over SE Edition models:

- 7-inch digital instrument cluster
- Heated front seats
- Heated steering wheel (excluding auto models)
- Electronic climate control
- Electronic parking brake (all models)*
- Rain-sensitive windscreen wipers
- Automatic lighting control
- Automatic anti-dazzle rear-view mirror
- Front passenger's seat height adjuster
- Front centre armrest with storage
- Fabric/premium leather-effect seat trim
- Panoramic rear-view camera
- Front and rear parking distance sensors
- Electrically folding door mirrors
- Black roof and A-pillars
- High gloss black B-pillars
- Dark-tinted rear windows
- Chrome-effect lower side window trim
- 17-inch diamond-cut bi-colour alloy wheels
- Remote control security alarm system
- LED front fog lights

Ultimate

Features over Elite Edition models:

- Multimedia Navi Pro infotainment system
 - Satellite Navigation
 - 10-inch colour touchscreen
 - 2D/3D street level mapping
 - European coverage
 - Points-of-interest search
- Alcantara seat trim
- Driver's seat with massage function
- IntelliLux LED® Matrix headlights with LED tail lights
- Adaptive cruise control (excluding auto models)
- Keyless entry and start
- Lane positioning assistant (excluding auto models)
- Black headliner
- Vauxhall Connect

*Excluding 75PS engine.

Corsa-e Range Highlights

SE Premium

Standard features include:

- Multimedia Navi infotainment system
 - Satellite navigation
 - 7-inch colour touchscreen
 - AM/FM/DAB digital radio
 - Bluetooth®
 - Apple CarPlay/Android Auto™
 - USB connection
- Six speakers
- Electronic climate control
- Rain-sensitive windscreen wipers
- Automatic lighting control
- Automatic anti-dazzle rear-view mirror
- Electric parking brake
- Rear parking distance sensors
- Keyless start
- 16-inch bi-colour alloy wheels
- High gloss black B-pillars
- Remote control security alarm system
- LED headlights with high beam assist
- Cruise control with intelligent speed limiter
- Trip computer
- Driver's seat height adjuster
- Electrically operated front and rear windows
- Electrically adjustable/heated door mirrors
- Lane departure warning with lane assist
- Speed sign recognition
- Flat-bottomed leather-covered steering wheel
- Driver drowsiness alert
- Automatic emergency city braking
- Anti-lock Braking System (ABS)
- Six airbags
- 60/40 split-folding rear seats
- Vauxhall Connect
- 7-inch digital instrument cluster
- Front centre armrest with storage

SRi Premium

Features over SE Premium models:

- Sports style front seats
- Black headliner
- Alloy-effect sports pedals
- LED tail lights
- LED front fog lights
- Black roof and A-pillars
- Dark tinted rear windows
- 17-inch bi-colour alloy wheels

Elite Premium

Features over SE Premium models:

- Multimedia Navi Pro infotainment system
 - 10-inch colour touchscreen
- IntelliLux LED® Matrix headlights with LED tail lights
- LED front fog lights
- Keyless entry and start
- 17-inch bi-colour alloy wheels
- Heated front seats
- Heated steering wheel
- Front passenger's seat height adjuster
- Fabric/premium leather-effect seat trim
- Panoramic rear-view camera
- Front and rear parking distance sensors
- Electrically folding door mirrors
- Black roof and A-pillars
- Dark-tinted rear windows
- Chrome-effect lower side window trim

Corsa SE Edition

VX_COR_33201



SE Edition OTR from £17,840

Infotainment:

- Multimedia system
 - 7-inch colour touchscreen
 - AM/FM/DAB digital radio
 - Bluetooth® audio streaming
 - Bluetooth® mobile phone portal
 - Apple CarPlay/Android Auto™
 - USB connection
- Six speakers

Interior convenience/styling:

- Air conditioning
- Flat-bottomed leather-covered steering wheel
- Cruise control with intelligent speed limiter
- Trip computer
- Speed-sensitive power-assisted steering
- Steering column adjustable for reach/rake
- Steering wheel audio/phone/cruise controls
- Driver's seat height adjuster
- 60/40 split-folding rear seats
- Electronic parking brake (auto models only)
- Paddle shift (auto models only)

Exterior convenience/styling:

- LED headlights
- LED daytime running lights
- High beam assist
- 16-inch silver 8-spoke alloy wheels
- Electrically operated front and rear windows
- Electrically adjustable/heated door mirrors

Safety/security:

- Remote control central locking
- Lane departure warning with lane keep assist
- Speed sign recognition
- Driver drowsiness alert
- Forward collision alert
- Automatic emergency city braking
- Hill start assist
- ISOFIX child seat fixings on outer rear seats

Corsa SRi Edition

VX_COR_32592



SRi Edition OTR from £21,390

Infotainment:

- Multimedia system
 - 7-inch colour touchscreen
 - AM/FM/DAB digital radio
 - Bluetooth® audio streaming
 - Bluetooth® mobile phone portal
 - Apple CarPlay/Android Auto™
 - USB connection
- Six speakers

Interior convenience/styling:

- 7-inch digital instrument cluster
- Electronic climate control
- Flat-bottomed leather-covered steering wheel
- Heated steering wheel (excluding auto models)
- Cruise control with intelligent speed limiter
- Trip computer
- Speed-sensitive power-assisted steering
- Steering column adjustable for reach/rake
- Steering wheel audio/phone/cruise controls
- Sport switch
- Heated sports-style front seats
- Rain-sensitive windscreen wipers
- Automatic lighting control
- Automatic anti-dazzle rear-view mirror
- Black headliner
- Alloy-effect sports pedals
- Paddle shift (auto models only)
- Electronic parking brake
- Front centre armrest with storage

Exterior convenience/styling:

- LED headlights and tail lights
- LED daytime running lights
- LED front fog lights
- High beam assist
- 17-inch diamond-cut gloss black 5-twinspoke alloy wheels
- Remote control central locking
- Electrically operated front and rear windows
- Chrome-effect exhaust tailpipe extension
- Black roof and A-pillars
- High gloss black B-pillars
- Dark-tinted rear windows
- Rear parking distance sensors

Safety/security:

- Lane departure warning with lane assist
- Speed sign recognition
- Driver drowsiness alert
- Forward collision alert
- Automatic emergency city braking
- Remote control security alarm system
- ISOFIX child seat fixings on outer rear seats

Corsa Elite Edition

VX_COR_33203



Elite Edition OTR from £19.905

Infotainment:

- Multimedia system
 - 7-inch colour touchscreen
 - AM/FM/DAB digital radio
 - Bluetooth® audio streaming
 - Bluetooth® mobile phone portal
 - Apple CarPlay/Android Auto™
 - USB connection
- Six speakers

Interior convenience/styling:

- 7-inch digital instrument cluster
- Electronic climate control
- Flat-bottomed leather-covered steering wheel
- Heated steering wheel (excluding auto models)
- Heated front seats
- Cruise control with intelligent speed limiter
- Trip computer
- Speed-sensitive power-assisted steering
- Steering column adjustable for reach/rake
- Steering wheel audio/phone/cruise controls
- Rain-sensitive windscreen wipers
- Automatic lighting control
- Automatic anti-dazzle rear-view mirror
- Driver's and front passenger's seat height adjuster
- Front centre armrest with storage
- Fabric/premium leather-effect seat trim
- Electronic parking brake (excluding 75PS engine)
- Paddle shift (auto models only)

Exterior convenience/styling:

- LED headlights
- LED front fog lights
- High beam assist
- 17-inch diamond-cut bi-colour alloy wheels
- Panoramic rear-view camera
- Front and rear parking distance sensors
- Electrically adjustable/folding/heated door mirrors
- Electrically operated front and rear windows
- Black roof and A-pillars
- High gloss black B-pillars
- Dark-tinted rear windows
- Chrome-effect lower side window trim

Safety/security:

- Lane departure warning with lane assist
- Speed sign recognition
- Driver drowsiness alert
- Forward collision alert
- Automatic emergency city braking
- Remote control security alarm system
- ISOFIX child seat fixings on outer rear seats

Corsa Ultimate

VX_COR_32593



Ultimate OTR from £26,525

Infotainment:

- Multimedia Navi Pro system
 - Satellite navigation
 - 10-inch colour touchscreen
 - 2D/3D street level mapping
 - European coverage
 - Points-of-interest search
 - AM/FM/DAB digital radio
 - Bluetooth® audio streaming
 - Bluetooth® mobile phone portal
 - Apple CarPlay/Android Auto™
 - USB connection
- Six speakers
- Vauxhall Connect

Interior convenience/styling:

- 7-inch digital instrument cluster
- Electronic climate control
- Black headliner
- Flat-bottomed leather-covered steering wheel
- Heated steering wheel (excluding auto models)
- Heated front seats
- Rain-sensitive windscreen wipers
- Automatic lighting control
- Automatic anti-dazzle rear-view mirror
- Adaptive cruise control (excluding auto models)
- Trip computer
- Speed-sensitive power-assisted steering
- Steering column adjustable for reach/rake
- Steering wheel audio/phone/cruise controls
- Alcantara seat trim
- Driver's seat with massage function
- Driver's and front passenger's seat height adjuster

- Front centre armrest with storage
- 60/40 split-folding rear seats
- Electronic parking brake
- Paddle shift (auto models only)

Exterior convenience/styling:

- IntelliLux LED® Matrix headlights with LED tail lights
- LED front fog lights
- High beam assist
- 17-inch diamond-cut bi-colour alloy wheels
- Panoramic rear-view camera
- Front and rear parking distance sensors
- Electrically adjustable/folding/heated door mirrors
- Electrically operated front and rear windows
- Black roof and A-pillars
- High gloss black B-pillars
- Dark-tinted rear windows
- Keyless entry and start
- Chrome-effect lower side window trim

Safety/security:

- Lane departure warning with lane assist
- Speed sign recognition
- Driver drowsiness alert
- Forward collision alert
- Automatic emergency city braking
- Remote control security alarm system
- ISOFIX child seat fixings on outer rear seats
- Lane positioning assistant (excluding auto models)

Corsa-e SE Premium

VX_COR_33202



SE Premium OTR from £28,805*

Infotainment:

- Multimedia Navi system
 - Satellite navigation
 - 7-inch colour touchscreen
 - 2D/3D street level mapping
 - European coverage
 - Points-of-interest search
 - AM/FM/DAB digital radio
 - Bluetooth® audio streaming
 - Bluetooth® mobile phone portal
 - Apple CarPlay/Android Auto™
 - USB connection
- Six speakers
- Vauxhall Connect

Interior convenience/styling:

- 7-inch digital instrument cluster
- Electronic climate control
- Flat-bottomed leather-covered steering wheel
- Rain-sensitive windscreen wipers
- Automatic lighting control
- Automatic anti-dazzle rear-view mirror
- Cruise control with speed limiter
- Trip computer
- Speed-sensitive power-assisted steering
- Steering column adjustable for reach/rake
- Steering wheel audio/phone/cruise controls
- Driver's seat height adjuster
- Front centre armrest with storage
- 60/40 split-folding rear seats
- Electronic parking brake

Exterior convenience/styling:

- LED headlights
- High beam assist
- 16-inch bi-colour alloy wheels
- High gloss black B-pillars
- Electrically operated front and rear windows
- Electrically adjustable/heated door mirrors
- Rear parking distance sensors
- Keyless start

Safety/security:

- Lane departure warning with lane assist
- Speed sign recognition
- Driver drowsiness alert
- Hill start assist
- Remote control security alarm system
- Automatic emergency city braking
- ISOFIX child seat fixings on outer rear seats

Corsa-e SRi Premium

VX_COR_e_32751



SRi Premium OTR from £30,055*

Infotainment:

- Multimedia Navi system
 - Satellite navigation
 - 7-inch colour touchscreen
 - 2D/3D street level mapping
 - European coverage
 - Points-of-interest search
 - AM/FM/DAB digital radio
 - Bluetooth® audio streaming
 - Bluetooth® mobile phone portal
 - Apple CarPlay/Android Auto™
 - USB connection
- Six speakers
- Vauxhall Connect

Interior convenience/styling:

- 7-inch digital instrument cluster
- Sports-style front seats
- Black headliner
- Alloy-effect sports pedals
- Electronic climate control
- Flat-bottomed leather-covered steering wheel
- Rain-sensitive windscreen wipers
- Automatic lighting control
- Automatic anti-dazzle rear-view mirror
- Cruise control with speed limiter
- Trip computer
- Speed-sensitive power-assisted steering
- Steering column adjustable for reach/rake
- Steering wheel audio/phone/cruise controls
- Driver's seat height adjuster
- Front centre armrest with storage
- 60/40 split-folding rear seats
- Electronic parking brake

Exterior convenience/styling:

- LED headlights and tail lights
- High beam assist
- 17-inch bi-colour alloy wheels
- Electrically operated front and rear windows
- Electrically adjustable/heated door mirrors
- Rear parking distance sensors
- Keyless start
- Black roof and A-pillars
- High gloss black B-pillars
- Dark-tinted rear windows

Safety/security:

- Lane departure warning with lane assist
- Speed sign recognition
- Driver drowsiness alert
- Hill start assist
- Remote control security alarm system
- Automatic emergency city braking
- ISOFIX child seat fixings on outer rear seats

Corsa-e Elite Premium

VX_COR_e_32752



Elite Premium

OTR from
£32,410*

Infotainment:

- Multimedia Navi Pro system
 - Satellite navigation
 - 10-inch colour touchscreen
 - 2D/3D street level mapping
 - European coverage
 - Points-of-interest search
 - AM/FM/DAB digital radio
 - Bluetooth® audio streaming
 - Bluetooth® mobile phone portal
 - Apple CarPlay/Android Auto™
 - USB connection
- Six speakers
- Vauxhall Connect

Interior convenience/styling:

- 7-inch digital instrument cluster
- Electronic climate control
- Flat-bottomed leather-covered steering wheel
- Heated front seats and steering wheel
- Rain-sensitive windscreen wipers
- Automatic lighting control
- Automatic anti-dazzle rear-view mirror
- Driver's and front passenger's seat height adjuster
- Front centre armrest with storage
- Fabric/premium leather-effect seat trim
- Electronic parking brake

Exterior convenience/styling:

- IntelliLux LED® Matrix headlights with LED tail lights
- High beam assist with anti-glare
- 17-inch bi-colour diamond-cut alloy wheels
- Panoramic rear-view camera
- Front and rear parking distance sensors
- Electrically adjustable/folding/heated door mirrors
- Electrically operated front and rear windows
- LED front fog lights
- Black roof and A-pillars
- High gloss black B-pillars
- Dark-tinted rear windows
- Keyless entry and start
- Chrome-effect lower side window trim

Safety/security:

- Lane departure warning with lane assist
- Speed sign recognition
- Driver drowsiness alert
- Remote control security alarm system
- Automatic emergency city braking
- ISOFIX child seat fixings on outer rear seats

Corsa Prices

	Pack Code	Fuel Type	Price (£)	VAT (£)	Total (£)	On-the-road RRP (£)	Financial Year 2022/23 BiK 20% (£)	WLTP Combined CO ₂ (g/km) [#] – pack code	Insurance groups
SE Edition									
1.2 (75PS)	AC48 ED11	Petrol	14,079.17	2,815.83	16,895.00	17,840.00	82.10	118	10E
1.2 (100PS) Turbo	AC48 EU61	Petrol	14,829.17	2,965.83	17,795.00	18,740.00	86.30	117	16E
1.2 (100PS) Turbo auto	AC48 EE81	Petrol	16,270.83	3,254.17	19,525.00	20,470.00	97.75	121	16E
1.5 (102PS) Turbo D	AC48 HT61	Diesel	15,754.17	3,150.83	18,905.00	19,830.00	84.95	105	20D
SRI Edition									
1.2 (100PS) Turbo	AS48 EU61	Petrol	17,037.50	3,407.50	20,445.00	21,390.00	98.67	119	17E
1.2 (130PS) Turbo auto	AS48 EF81	Petrol	19,287.50	3,857.50	23,145.00	24,090.00	115.25	123	22E
Elite Edition									
1.2 (75PS)	AE48 ED11	Petrol	15,800.00	3,160.00	18,960.00	19,905.00	95.02	121	12E
1.2 (100PS) Turbo	AE48 EU61	Petrol	16,550.00	3,310.00	19,860.00	20,805.00	99.37	120	18E
1.2 (100PS) Turbo auto	AE48 EE81	Petrol	17,991.67	3,598.33	21,590.00	22,535.00	107.73	123	15E
1.5 (102PS) Turbo D	AE48 HT61	Diesel	17,475.00	3,495.00	20,970.00	21,895.00	93.90	107	19E
Ultimate									
1.2 (100PS) Turbo	AM48 EU61	Petrol	21,316.67	4,263.33	25,580.00	26,525.00	122.63	119	17E
1.2 (130PS) Turbo auto	AM48 EF81	Petrol	23,683.33	4,736.67	28,420.00	29,365.00	140.73	123	23E

Corsa's petrol and diesel engines meet the Real Driving Emissions Step 2 (RDE2) standards.

WLTP Combined CO₂ (g/km) figures are based on a configured vehicle as per pack code for UK with no options fitted.

[#]Provisional fuel consumption and CO₂ figures are determined according to the WLTP test cycle. CO₂ figures, BiK values and RRP pricing shown above are for a standard vehicle without any additional optional equipment. CO₂ figures are used to calculate Vehicle Excise Duty (VED) for the first registration of the vehicle and BiK. The addition of optional extras could increase the certified CO₂ emission output. This in turn may affect the amount of VED payable upon registration, and, for company car drivers, the P11D value and the amount of Benefit in Kind (BiK) tax payable. Figures shown are for comparison purposes and should only be compared to the fuel consumption and CO₂ values of other cars tested to the same technical standard. The fuel consumption achieved, and CO₂ produced, in real world conditions will depend upon a number of factors including, but not limited to: the accessories fitted (pre and post registration); variations in weather; driving styles and vehicle load. The WLTP (Worldwide Harmonised Light Vehicles Test Procedure) is used to measure fuel consumption and CO₂ figures. Full data relating to WLTP test cycles can be found at: www.vauxhall.co.uk/wltp

Please note: On-the-road recommended retail prices (RRP) include number plates and delivery to Retailer of £700.00 (inc. £116.67 VAT), 12 months' Vehicle Excise Duty and new vehicle first registration fee of £55.00. Excludes fuel and insurance. Company Car Benefit in Kind (BiK) rates are monthly based on the standard paint price.

Corsa-e Prices

	Pack Code	Price (£)	VAT (£)	Total (£)	On-the-road RRP before PiCG (£)	On-the-road RRP after PiCG (£)	Financial Year 2022/23 BiK 20% (£)	WLTP Combined CO ₂ (g/km) – pack code	Insurance groups
SE Premium 11kW									
Electric Propulsion (136PS) auto	AD48 9CQ1	24,625.00	4,925.00	29,550.00	30,305.00	28,805.00	10.07	0	24E
SRI Premium 11kW									
Electric Propulsion (136PS) auto	AT48 9CQ1	25,666.67	5,133.33	30,800.00	31,555.00	30,055.00	10.48	0	24E
Elite Premium 11kW									
Electric Propulsion (136PS) auto	AX48 9CQ1	27,629.17	5,525.83	33,155.00	33,910.00	32,410.00	11.28	0	25E

WLTP Combined CO₂ (g/km) figures are based on a configured vehicle as per pack code for UK with no options fitted.

Please note: On-the-road recommended retail prices (RRP) include number plates and delivery to Retailer of £700.00 (inc. £116.67 VAT), 12 months' Vehicle Excise Duty and new vehicle first registration fee of £55.00. Excludes fuel and insurance. Company Car Benefit in Kind (BiK) rates are monthly based on the standard paint price. Price has been calculated using manufacturer estimates and includes a £1,500.00 OZEV grant which has been deducted from the price of the vehicle (OZEV Grant not available in the Isle of Man). The grant is a government incentive and is subject to withdrawal prior to delivery of your vehicle. Retailers may be required to carry out more than one credit check during the course of the order process. You may be required to place a deposit when placing your order with your supplying Retailer.

Corsa-e is not covered by our Price Protection Guarantee. See 'Further Information' page for details.

Safety

Standard Features – The following features are standard across the entire Corsa range.

Airbags

- Driver's airbag
- Front passenger's airbag
- Front seat side-impact airbags
- Full-size curtain airbags

Seating

- Height-adjustable head restraints

Seatbelts

- Inertia-reel lap and diagonal seatbelts
- 'Seatbelt unfastened' audible warning and warning light

Braking

- Automatic emergency city braking – The system works automatically in conjunction with forward collision alert, at speeds between 3mph and 53mph, and detects both vehicles and pedestrians. If no avoiding action is taken by the driver, at speeds below 19mph the system automatically slows the vehicle to a full stop with emergency braking of 0.9g. At speeds from 19mph to 53mph it brakes automatically to reduce speed by a maximum of 14mph – to reduce speed even further the driver must brake him/herself

- Anti-lock Braking System (ABS)
- Emergency brake assist – When emergency braking is detected the vehicle automatically applies the maximum possible braking assistance
- Electronic brakeforce distribution – Automatically apportions the optimum braking force to each wheel
- Hill start assist – Briefly maintains rear brake pressure to stop the vehicle rolling back when pulling away on an incline

Child safety

- Deactivation switch for front passenger's airbag
- ISOFIX child seat mountings incorporating top tether anchor points located on outer rear seats (does not include child seat) – Allows ISOFIX child safety seats to be securely fixed into the car. The ISOFIX mounting system reduces forward movement in an accident and makes the child seat easier to install
- Child-proof locks on rear doors
- Bonnet/headlight/wiper structure – Designed to reduce pedestrian head and upper body injuries
- Upper and lower bumper design – Reduces upper and lower leg injuries

Stability

- Electronic Stability Programme (ESP)
ESP monitors many different inputs to determine when the car starts to lose traction, it can then immediately respond by varying the brake pressure between up to three wheels and adjust the engine output to help correct the loss of traction and improve stability

Additional ESP features

- Traction control
- Cornering brake control
- Straight line stability control
- Drag torque control – Maintain stability on slippery roads when lifting off the accelerator or changing gear

Tyre pressure

- Tyre pressure monitoring system

Vauxhall driver assistance systems are intended to support the driver within the system-imminent limitations. The driver remains responsible for the driving task at all times.



Hill start assist.



ISOFIX child seat mountings.



Automatic emergency city braking.

Driver Assistance

Standard Features – The following features are standard across the entire Corsa range.
Specific features by model are outlined in the separate tabular information.

Cruise control with speed limiter

With steering wheel mounted controls. Enables you to maintain a constant speed, making it ideal for economical motorway driving.

Front camera system

A range of class-leading driver assistance and safety features are controlled by the front camera system.

Forward collision alert

The system operates automatically from 3mph and gives an audible warning as well as a visual warning when approaching another vehicle too quickly.

Lane departure warning with lane assist

If the driver has not actively steered or signalled, the lane departure warning system provides gentle steering correction and warns when the car moves outside of lane markings at speeds above 40mph.

- Warning light in instrument cluster
- Facia on/off switch

Driver drowsiness alert

The system monitors driving time and driving behaviour to help prevent accidents caused by tiredness.

Speed sign recognition

Detects and then displays speed limits, reducing uncertainty and the risk of speeding.

- Recognises different speed signs, including temporary speed restrictions
- Displays reminder in the instrument cluster
- Works in conjunction with the cruise control/speed limiter to help the driver adapt to the recognised speed limit

Model Specific Features

	Electric models						
	SE Edition	SRi Edition	Elite Edition	Ultimate	SE Premium	SRi Premium	Elite Premium
Driver Assistance							
Rain-sensitive windscreen wipers		●	●	●	●	●	●
Automatic anti-dazzle rear-view mirror		●	●	●	●	●	●
Rear parking distance sensors		●	●	●	●	●	●
Front and rear parking distance sensors			●	●			●
Panoramic rear-view camera			●	●			●
Electrically folding door mirrors			●	●			●
Adaptive cruise control				excl auto			
Lane positioning assistant				excl auto			
Electronic parking brake – Centre console switch in lieu of handbrake lever	auto only	●	●*	●	●	●	●
Paddle shift	auto only	auto only	auto only	auto only			

*Excluding 75PS engine.

Driver Information and Security

Standard Features – The following features are standard across the entire Corsa range.
Specific features by model are outlined in the separate tabular information.

Driver Information

Instrumentation

- Speedometer and rev counter
- Fuel gauge with low fuel level warning light
- Water temperature gauge with warning light
- Shift-up indication light (manual models only)
– indicates when to change gear for optimum fuel economy

Driver information display (centrally located in instrument cluster)

- Service-due indicator
- Deflation detection system

Multi-function trip computer (displayed on driver information display)

- Trip mileage
- Vehicle range based on remaining fuel
- Average speed
- Average fuel economy
- Instantaneous fuel economy

Central fascia display (format dependent on infotainment unit)

- Audio information
- Digital clock with automatic RDS time adjustment
- Outside air temperature with ice warning function
- Additional features dependent on infotainment unit
(see infotainment for details)

Security

- Electronic engine deadlock immobiliser
- Steering column lock
- Lockable fuel filler flap
- Remote control central door locking
- Two keys – One folding with integral remote

Model Specific Features

	Electric models						
	SE Edition	SRi Edition	Elite Edition	Ultimate	SE Premium	SRi Premium	Elite Premium
Driver Information							
3.5-inch colour instrument cluster	●						
7-inch digital instrument cluster		●	●	●	●	●	●
Security							
Remote control security alarm system		●	●	●	●	●	●
Keyless start					●	●	
Keyless entry and start				●			●

Convenience

Standard Features – The following features are standard across the entire Corsa range.
Specific features by model are outlined in the separate tabular information.

Interior Convenience

- 12-volt electrical accessory socket
- Driver's and front passenger's sunvisors incorporating vanity mirrors with covers
- Illuminated glovebox with lid
- Interior courtesy light and front map reading lights
- Luggage compartment lighting
- Two-litre open door pockets

Heating and Ventilation

- Cabin particulate filter – removes dust, airborne particles and pollen
- Four-speed fan with illuminated controls
- Four adjustable facia vents
- Windscreen and side window demist vents

Exterior Convenience

- Solar heat-absorbing windscreen
- Two-speed windscreen wipers with variable intermittent wipe
- Electrically operated front and rear windows with safety autoreverse and one-touch facility
- Glazed tailgate with heated window and wash/wipe facility
- Twin electrically adjustable/heated door mirrors
- Remote control central door locking

Model Specific Features/Option

	Electric models						
	SE Edition	SRi Edition	Elite Edition	Ultimate	SE Premium	SRi Premium	Elite Premium
Interior Convenience							
Front centre armrest with storage		●	●	●	●	●	●
LED ambient lighting			●	●			●
Interior Style							
Black headliner		●		●		●	
Heating and Ventilation							
Air conditioning with air recirculation facility	●						
Electronic climate control		●	●	●	●	●	●
Heated front seats		●	●	●			●
Heated steering wheel		excl auto	excl auto	excl auto			●
Exterior Convenience							
Fixed panoramic glass sunroof*		£500	£500	£500		£500	£500

*Optional at extra cost including VAT.

Exterior Style and Lighting

Standard Features – The following features are standard across the entire Corsa range.
Specific features by model are outlined in the separate tabular information.

Exterior Styling

- Body-colour front and rear bumpers
- Body-colour door handles and mirror housings
- Chrome logo bar

Exterior Lighting

- LED headlights
- High beam assist
- Lights-on audible warning
- LED daytime running lights
- Headlight levelling system

- Rear fog light
- Rear reversing light
- Centre rear brake light
- Hazard warning lights

Model Specific Features

	Electric models						
	SE Edition	SRI Edition	Elite Edition	Ultimate	SE Premium	SRI Premium	Elite Premium
Exterior Styling							
Black roof and A-pillars		●	●	●		●	●
Body-colour roof and A-pillars	●	No-cost	No-cost	No-cost	●	No-cost	No-cost
Black lower side window mouldings	●	●			●	●	
Chrome-effect lower side window trim			●	●			●
Sports front and rear body styling		●				●	
High gloss black B-pillars		●	●	●	●	●	●
Chrome-effect exhaust tailpipe extension		●					
Solar heat-absorbing windows	●				●		
Dark-tinted rear side and tailgate windows		●	●	●		●	●
Exterior Lighting							
Automatic lighting control		●	●	●	●	●	●
LED front fog lights		●	●	●		●	●
Automatic headlight levelling system				●			●
IntelliLux LED® Matrix headlights				●			●
LED tail lights		●		●		●	●

Infotainment

Standard Features

Multimedia

Standard on SE Edition, SRi Edition and Elite Edition models

Onboard features:

- 7-inch colour touchscreen
- DAB Digital radio
- RDS with Traffic Programme
- AM/FM stereo radio with 25 station presets
- Six speakers
- 20 watts per channel output

Media connections:

- USB connection with iPod control
- Bluetooth® A2DP audio streaming (Advanced Audio Distribution Profile)

Mobile phone portal:

- Bluetooth® connectivity
- Vehicle microphone
- Handsfree calls via steering wheel controls
- Phone book access – Contacts/last calls/missed calls etc. are mirrored on the display and are easily navigated using the touchscreen (features dependent on mobile phone)

Smartphone interface:

- Apple CarPlay
- Android Auto™
- Smartphone projection that allows operations via voice command, touchscreen and buttons to control apps and music playback

Additional features:

- Steering wheel-mounted audio controls
- Flexible roof-mounted aerial

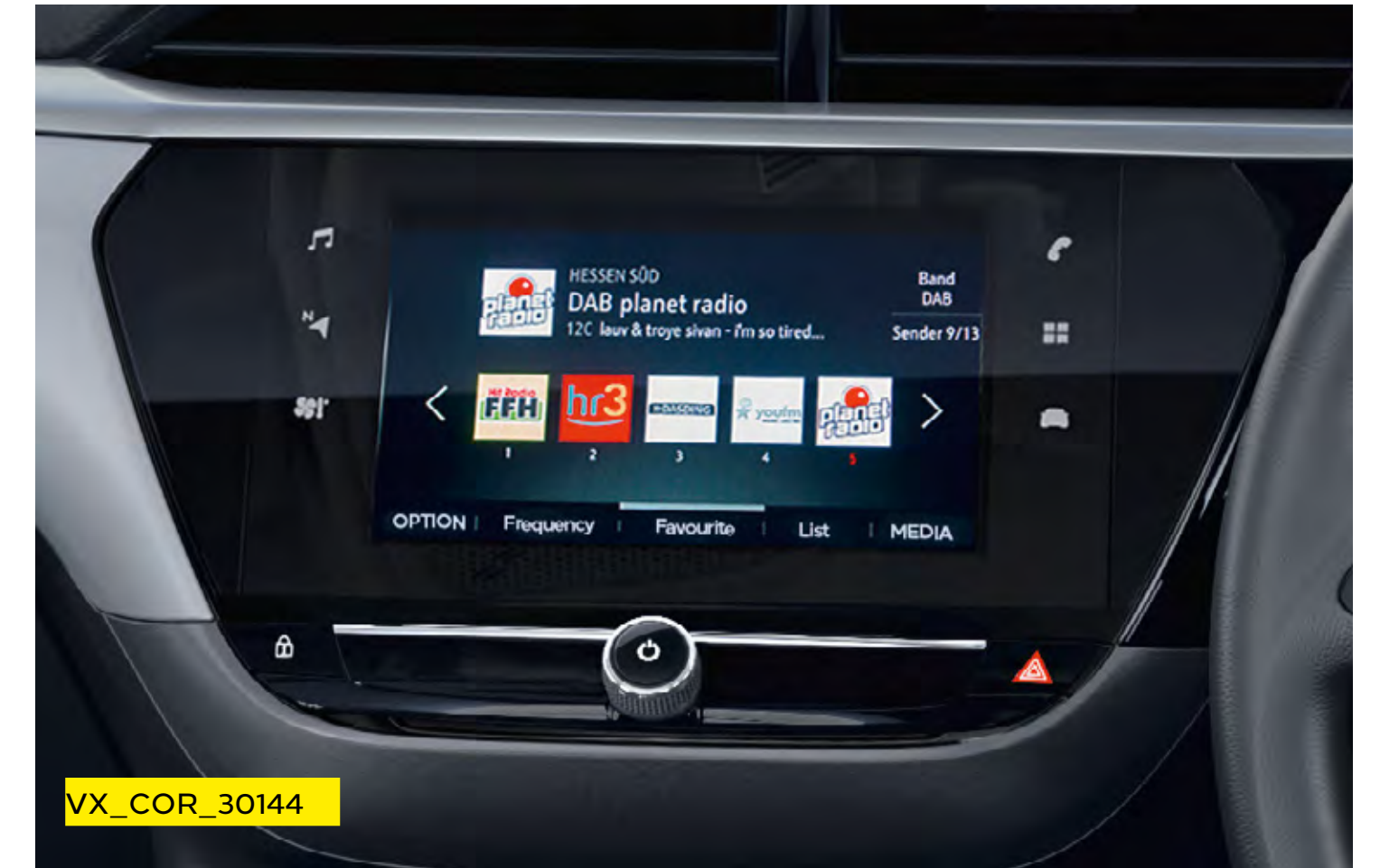

Please note that compatibility and certain functions may be different depending on the type of device and operating system you're using with the Multimedia systems. Apple CarPlay is a trademark of Apple Inc. Apple and iPhone are trademarks of Apple Inc., registered in the U.S. and other countries. Android is a trademark of Google Inc, also registered in the U.S. and other countries. *Services may require a subscription/fee and are subject to mobile network coverage and availability. Standard on Nav models only. Live navigation services are included for 3 years and thereafter are subject to an additional subscription fee.

Please note, Apple CarPlay screen illustrated on 10-inch colour touchscreen.

Infotainment

Nav Model Features

Multimedia Navi with 7-inch touchscreen

Optional on SE Edition, SRi Edition and Elite Edition models at £500 including VAT
Standard on Corsa-e SE Premium and SRi Premium models

Features as Multimedia, with the addition of navigation features:

Onboard features:

- 7-inch colour touchscreen

Navigation features:

- Satellite navigation system
- 2D/3D street level mapping
- European coverage
- Points-of-interest search
- Map updates via USB

Vauxhall Connect*

Standard on Ultimate models
Standard on Corsa-e SE Premium, SRi Premium and Ultimate models

e-Call and b-Call:

Help when you need it, 24/7, 365 days a year, that's what you get with new Vauxhall Connect. In an emergency or breakdown, you'll be put in touch with a trained advisor, with just the touch of a button.

Multimedia Navi Pro with 10-inch touchscreen

Standard on Ultimate models
Standard on Corsa-e Elite Premium models

Onboard features:

- 10-inch colour touchscreen

Navigation features:

- Satellite navigation system
- 2D/3D street level mapping
- European coverage
- Points-of-interest search
- Map updates via USB

Live navigation and more:

You can also access live navigation services, receive regular vehicle diagnostic info plus there's a host of remote convenience features available through the MyVauxhall app.

- **Peace of mind:** emergency call, breakdown call and regular vehicle status and information
- **Convenience:** remote functions (e.g. lock/unlock the door)
- **Our additional services for electric vehicles:** trip planning, remote settings or public charging solutions – we keep you going!
- **Smart driving:** enjoy a relaxed ride thanks to live navigation and trip management



*Services may require a subscription/fee and are subject to mobile network coverage and availability. Standard on Nav models only. Live navigation services are included for 3 years and thereafter are subject to an additional subscription fee.

Interior Styling and Comfort



Steering wheel:

- Three-spoke design
- Flat-bottomed
- Leather-covered
- Satin chrome-effect bezel

Facia and door trim:

- Mistral facia
- Jet Black door panels
- Chrome-effect interior door handles

Seat trim:

- Fresez Marvel Black fabric seat trim inserts
- Mistral fabric side bolsters and surrounds

Seating:

- Comfort front seats
- Driver's seat (six-way adjustable):
 - Height (up/down)
 - Reach (fore/aft)
 - Backrest (upright/recline)
- Front passenger's seat (four-way adjustable):
 - Reach (fore/aft)
 - Backrest (upright/recline)
- 60/40 split folding rear seats

SE model illustrated.

Steering wheel:

- Three-spoke design
- Flat-bottomed
- Leather-covered
- Satin chrome-effect bezel

Facia and door trim:

- Liquid Palladium facia with Hot Red accents
- Liquid Palladium cloth inserts
- Chrome-effect interior door handles

Seat trim:

- Banda Marvel Black fabric seat trim inserts
- Mistral fabric side bolsters and surrounds
- Signal Red and Dark Titanium seat stitching

Seating:

- Sports-style front seats
- Driver's seat (six-way adjustable):
 - Height (up/down)
 - Reach (fore/aft)
 - Backrest (upright/recline)
- Front passenger's seat (four-way adjustable):
 - Reach (fore/aft)
 - Backrest (upright/recline)
- 60/40 split folding rear seats

Pedals:

- Sports, alloy-effect

Interior Styling and Comfort



Steering wheel:

- Three-spoke design
- Flat-bottomed
- Leather-covered
- Satin chrome-effect bezel

Facia and door trim:

- Silent Black facia with Galvano Chrome inserts
- Silent Black door panels
- Chrome-effect interior door handles

Seat trim:

- Captain Blue/Mistral fabric seat trim inserts
- Premium leather-effect side bolsters and surrounds

Seating:

- Comfort front seats
- Driver's seat (six-way adjustable):
 - Height (up/down)
 - Reach (fore/aft)
 - Backrest (upright/recline)
- Front passenger's seat (six-way adjustable):
 - Height (up/down)
 - Reach (fore/aft)
 - Backrest (upright/recline)
- 60/40 split folding rear seats

Steering wheel:

- Three-spoke design
- Flat-bottomed
- Leather-covered
- Satin chrome-effect bezel

Facia and door trim:

- Jet Black facia with Galvano Chrome inserts
- Jet Black door panels
- Chrome-effect interior door handles

Seat trim:

- Alcantara seat trim inserts
- Jet black side bolsters and surrounds

Seating:

- Driver's seat with massage function (six-way adjustable):
 - Height (up/down)
 - Reach (fore/aft)
 - Backrest (upright/recline)
- Front passenger's seat (six-way manual adjustable):
 - Height (up/down)
 - Reach (fore/aft)
 - Backrest (upright/recline)
- 60/40 split folding rear seats

Exterior Colours

Jade White (G2o)*
Brilliant paint



VX_COR_30169

Diamond Black (G7o)**
Two-coat metallic paint **£600**



VX_COR_30168

Quartz Grey (G4i)***
Two-coat metallic paint **£600**



VX_COR_30165

Crystal Silver (GAU)****
Two-coat metallic paint **£600**



VX_COR_33200

Voltaic Blue (G6L)**
Two-coat metallic paint **£600**



VX_COR_30167

Power Orange (GPQ)**
Two-coat premium metallic paint **£700**



VX_COR_30170

Hot Red (G1R)**
Two-coat premium metallic paint **£700**







VX_COR_30163

The colours reproduced may vary slightly from the actual paint colour. As a result they should be used as a guide only. Your Vauxhall Retailer has a comprehensive display of our paint samples.

*Standard exterior paint. **Optional at extra cost including VAT. †SRi and Ultimate models only. ††SE and Elite models only.

Wheels and Tyres

						Electric models		
		SE Edition	SRI Edition	Elite Edition	Ultimate	SE Premium	SRI Premium	Elite Premium
 VX_COR_30172	16-inch silver 8-spoke alloy wheels • 195/55 R 16 tyres. • Emergency tyre inflation kit (in lieu of spare wheel)	●						
 VX_COR_30174	16-inch silver bi-colour alloy wheels • 195/55 R 16 ultra low rolling resistance tyres. • Emergency tyre inflation kit (in lieu of spare wheel)					●		
 VX_COR_30177	17-inch diamond-cut bi-colour alloy wheels • 205/45 R 17 tyres. • Emergency tyre inflation kit (in lieu of spare wheel)		●	●	●			
 VX_COR_30178	17-inch bi-colour alloy wheels • 205/45 R 17 tyres. • Emergency tyre inflation kit (in lieu of spare wheel)						●	●
Provision for spare wheel fitment (spare wheel is Retailer-fit)*		£20*	£20*	£20*	£20*			

*Optional at extra cost including VAT. Not available on Corsa-e electric models.

Petrol Engines

	1.2 (75PS)	1.2 (100PS) Turbo	1.2 (130PS) Turbo automatic
Capacity	1199cc	1199cc	1199cc
Maximum power	75PS (55kW) @ 5750rpm	100PS (74kW) @ 5500rpm	130PS (96kW) @ 5500rpm
Maximum torque	118Nm (87lb.ft.) @ 2750rpm	205Nm (151lb.ft.) @ 1750rpm	230Nm (169lb.ft.) @1750rpm
Configuration	3 cylinders, 4 valves per cylinder, double overhead camshafts	3 cylinders, 4 valves per cylinder, double overhead camshafts	3 cylinders, 4 valves per cylinder, double overhead camshafts
Fuel/induction system	Naturally aspirated with Variable Valve Timing. Multi-point sequential fuel injection	Turbocharger. Multi-point sequential fuel injection	Turbocharger. Multi-point sequential fuel injection
Emission compliance	Euro 6d	Euro 6d	Euro 6d
Service interval	12,500 miles or 1 year (whichever occurs sooner)	12,500 miles or 1 year (whichever occurs sooner)	12,500 miles or 1 year (whichever occurs sooner)

Diesel Engine

	1.5 (102PS) Turbo D BlueInjection
Capacity	1499cc
Maximum power	102PS (75kW) @ 3500rpm
Maximum torque	250Nm (184lb.ft.) @ 1750rpm
Configuration	4 cylinders, 4 valves per cylinder, double overhead camshafts
Fuel/induction system	Turbocharger with intercooler. Variable Valve Timing. Multi-point sequential fuel injection
Emission compliance	Euro 6d
Service interval	20,000 miles or 1 year (whichever occurs sooner)

Performance, Fuel Economy and Emissions

	Performance (manufacturer's figures)		Fuel economy mpg (litres/100km) [#]		CO ₂ emissions g/km [#]		Vehicle Excise Duty*		BiK rates from - 2022/23 tax year
	Maximum speed (mph)	Acceleration 0-60mph (sec)	Combined Low	Combined High	Combined Low	Combined High	First year rate	Standard rate	
1.2 (75PS)	108	12.4	47.8 (5.9)	53.3 (5.3)	118	133	£190	£165	28%
1.2 (100PS) Turbo	121	9.3	47.9 (5.9)	52.3 (5.4)	117	134	£190	£165	28%
1.5 (102PS) Turbo D	117	9.6	62.8 (4.5)	70.6 (4.0)	105	107	£190	£165	26%
1.2 (100PS) Turbo automatic	119	10.2	45.7 (6.2)	48.7 (5.8)	121	140	£190	£165	29%
1.2 (130PS) Turbo automatic	129	8.2	47.1 (6.0)	50.4 (5.6)	123	136	£190	£165	29%

Weights and Towing Data_{kg}

	Gross vehicle weight	Maximum towing weights Trailer with brakes (without brakes)
1.2 (75PS)	1550	500 (500)
1.2 (100PS) Turbo	1620	1200 (580)
1.5 (102PS) Turbo D	1660	1200 (580)
1.2 (100PS) Turbo automatic	1645	1200 (580)
1.2 (130PS) Turbo automatic	1650	1200 (580)

[#]Figures shown are for comparison purposes and should only be compared to the fuel consumption and CO₂ values of other cars tested to the same technical standard. The fuel consumption achieved, and CO₂ produced, in real world conditions will depend upon a number of factors including, but not limited to: the accessories fitted (pre and post registration); variations in weather; driving styles and vehicle load. The WLTP (Worldwide Harmonised Light Vehicles Test Procedure) is used to measure fuel consumption and CO₂ figures. The CO₂ figures display a range to reflect the highest value for the highest emitting version with all available options added, through to a minimum value to represent the lowest emitting version in standard specification. *Correct at time of publication.

Please note: Gross vehicle weight is the total permissible weight of the vehicle including passengers and their luggage. The **maximum roof rack loading** should not exceed 70kg. The **maximum towing weights** are based on the ability of the car, with two occupants of 75kg each, to restart on a 12% gradient, which is approximately 1 in 8.3, at sea level. The permitted trailer load applies up to the specified incline and up to an altitude of 1000 metres above sea level. The permissible gross train weight decreases by 10% for every 1000 metres of additional altitude. At altitudes above 1500 metres, the engine output may drop with a corresponding reduction in towing capability. Any extra weight, such as luggage or additional passengers, should be deducted from the maximum towing weight. With a trailer fully loaded, **maximum noseweight** should not exceed 55kg. Always fit Vauxhall towing attachments and accessories available from your Vauxhall Retailer. They are designed specifically for Vauxhall models and carry a 12-month guarantee. During trailer towing do not exceed a maximum speed of 60mph. This speed limit is also applicable in countries with higher permitted speeds for trailer-vehicle combinations. Pay attention to the local speed limits. For trailers with low driving stability and caravans the use of an oscillation damper is strongly recommended.

Specifications

Transmission

- Front-wheel drive
- Five-speed manual gearbox
 - Available on 1.2 (75PS) models.
- Six-speed manual gearbox
 - Available on 1.2 (100PS) Turbo/1.5 (102PS) Turbo D models.
- Eight-speed automatic transmission
 - Available on 1.2 (100PS) Turbo /1.2 (130PS) Turbo models.

Steering

- Speed-sensitive power-assisted steering

Brakes

- Anti-lock Braking System (ABS)
- Electronic brakeforce distribution
- Emergency brake assist
- Cornering brake control
- Straight line stability control

1.2i (75PS)

Front ventilated discs: 356mm diameter

Rear drums: 203mm diameter

1.2i (100PS)/1.5 (102PS) Turbo D

Front ventilated discs: 381mm diameter

Rear discs: 356mm diameter

Fuel tank capacity

- 1.2 (75PS) 40 litres
- 1.2 (100PS) Turbo/1.2 (130PS) Turbo 44 litres
- 1.5 (102PS) Turbo D 41 litres

Start/Stop technology

Corsa's Start/Stop system offers real benefits by improving fuel economy and reducing CO₂ emissions, particularly in town. It does this by automatically stopping the engine when you come to a standstill, and then restarting as you prepare to move off.

Before automatically stopping the engine a number of system checks are carried out to ensure that it is both safe and practical to do so. To ensure safety, the driver must depress the clutch pedal, shift in to neutral, and then release the clutch pedal.

System checks carried out before Auto Stop activates include:

- Start/Stop system is not manually deactivated via the facia button
- Sufficient brake vacuum is available to prevent the car rolling down an incline
- Battery is in good condition and charged
- Outside air temperature and engine temperature are above specified minima
- Electronic climate control (where fitted) is not in maximum heating or maximum cooling mode
- Self-cleaning function of the diesel particulate filter is not active

If all of these conditions are satisfied then the vehicle will Auto Stop.

When you are ready to pull away from standstill, Auto Restart is activated by depressing the clutch pedal.

Whilst at a standstill the vehicle is continually monitored. If necessary, the engine will automatically be restarted. Conditions that would initiate an Auto Restart include:

- Low battery level
- Brake vacuum below specified minimum
- Start/Stop system is manually deactivated
- Stationary for 5.5 minutes

Corsa-e Specifications

Single-speed electronic drive selector

As the motor is an all-electric single-speed drive unit, there is no need for multiple gears. Instead, the shifter lets the driver select from the following:

- Park
- Reverse
- Neutral
- Drive
- Braking (for increased regenerative braking)

Drive Mode Selector

The driver can determine the driving style through selecting one of the following modes:

- **Sport:** for a dynamic drive with a responsive throttle and the highest top speed and torque
- **Normal:** for a balanced drive that offers a compromise between performance and energy efficiency
- **ECO:** for maximum range and energy efficiency. The ECO mode deactivates all unnecessary energy-consuming features and reduces the top speed, torque and overall performance

Drivetrain	Corsa-e
CO ₂ emissions	0g/km
Maximum power	100kW (136PS)
Maximum torque	260Nm (192lb. ft.)
Acceleration 0-60mph	7.6 sec
Maximum speed	93mph
Transmission	Automatic electric drive with fixed gear ratio
Kerbweight	1530kg
Service interval	Initial inspection at 8,000 miles/ 1 year (whichever comes sooner). Thereafter 16,000 miles/2 years (whichever comes sooner)

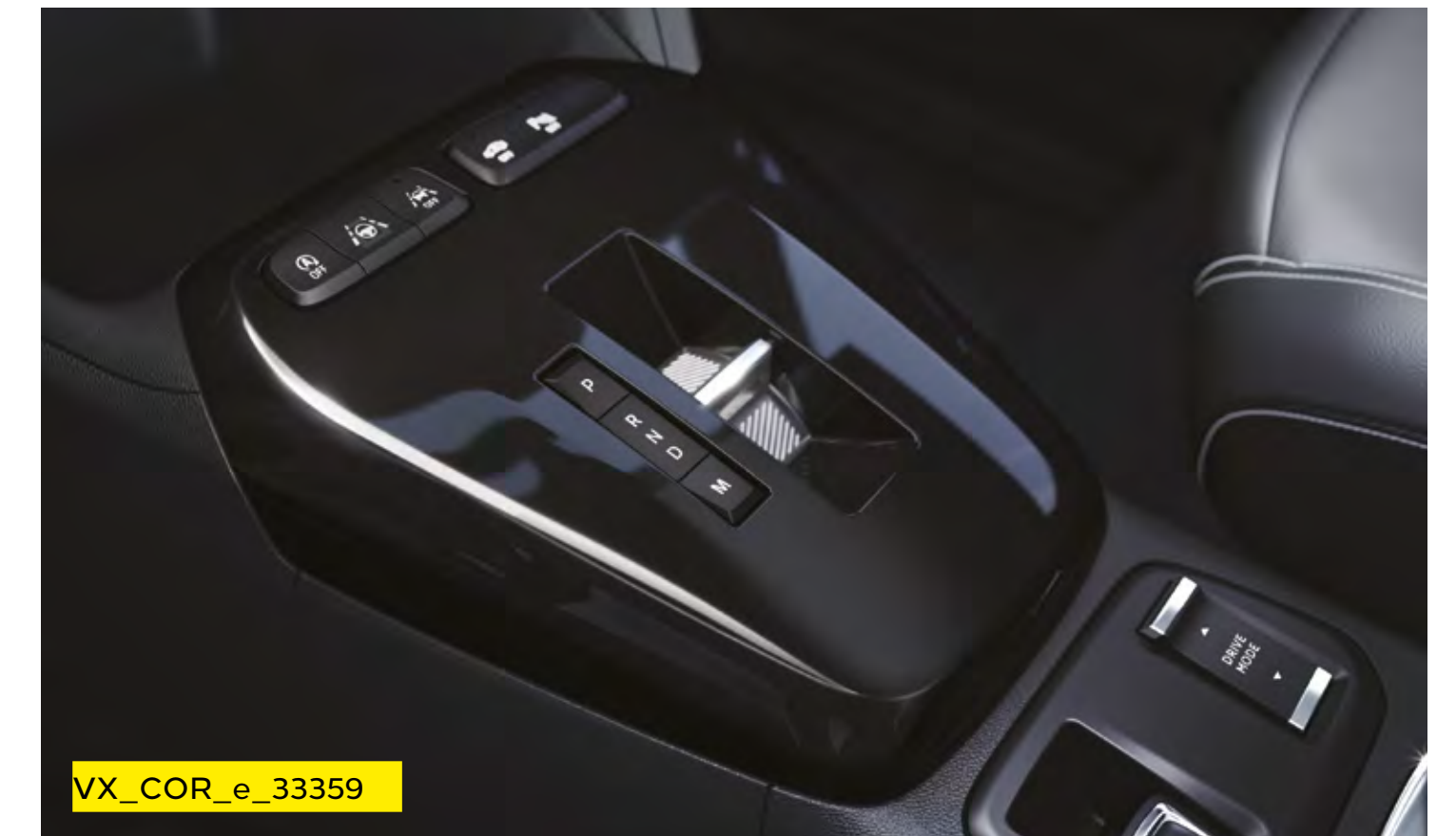
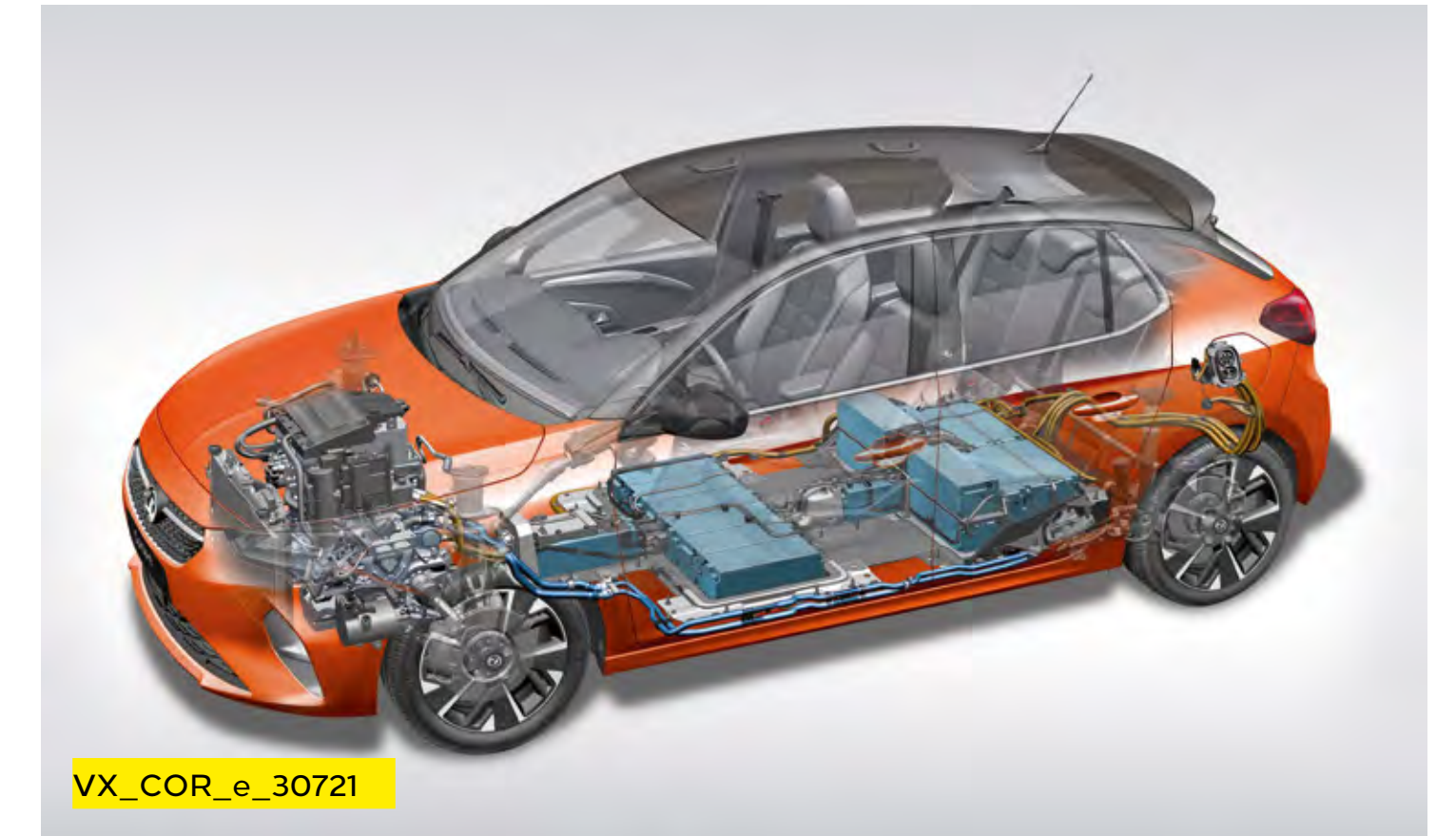

Corsa-e Specifications

Charging

Corsa-e is fitted with a 11kW on board charger and is also equipped with a Mode 3 cable as standard as shown below. Additional charging accessories are available at extra cost, see Accessories page for more details or consult your local Retailer.

	11kW on-board charger
Mode 3, 3-phase 22kW cable	Standard
Mode 2, emergency charging cable	Optional accessory £584

The charging flap's Padlock LED lights up when the cable is correctly plugged in and locked and then acts as a user interface to show the charging status via coloured LED lights:

- **White:** welcome light that helps to light up the area, especially useful in dark conditions
- **Flashing green:** charging in progress
- **Solid green:** charging complete
- **Solid blue:** delayed charging toggled; changes to flashing green when charging commences
- **Solid red:** malfunction

The driver may also choose from two settings:

- **Immediate charging (the standard setting):** Starts charging as soon as the vehicle is docked for charging
- **Delayed charging:** This is especially useful for when cheaper electric rates are desired, e.g. charging at night. Simply enter a charging start time

Please note, EV range assumes that vehicle has been pre-conditioned prior to journey. This function can be accessed either via MyVauxhall App (standard with all Corsa-e) or by using the Multimedia Navi Pro infotainment system (standard on Elite Premium).

Charging		
Supply	Socket	Charge Time (0-100%)
AC current - Domestic 3 pin socket (2.3kW)	Type 2	21h 45m
AC current - Home wallbox or public charger (7kW)	Type 2	7h 30m
AC current - Public charger (11kW)*	Type 2	5h
DC current - Rapid charger (100kW)	CCS	30m (0-80%)

Battery	
Battery capacity	50kWh
AC on-board charger speed (standard)	11kW
EV range (WLTP high)**	222 miles
Energy consumption (Combined low/high)	16.5-16.8kWh/100km
Battery warranty	8 years/100,000 miles/70% capacity



The Corsa-e is a battery electric vehicle requiring mains electricity for charging. Range data given has been determined according to WLTP test procedure methodology. The figures shown are intended for comparability purposes only and should only be compared to other cars tested to the same technical standard. The range you achieve under real world driving conditions will depend upon a number of factors, including but not limited to: the accessories fitted (pre and post registration); charging frequency; personal driving style; vehicle load and route characteristics; variations in weather; heating/air conditioning; pre-conditioning and battery condition. For more information, contact your local Vauxhall Retailer.

*Requires optional 11kW on board charger. **WLTP preliminary.

Dimensions and Capacities

All measurements in mm (inches) unless stated otherwise.

VX_COR_31767



VX_COR_30093

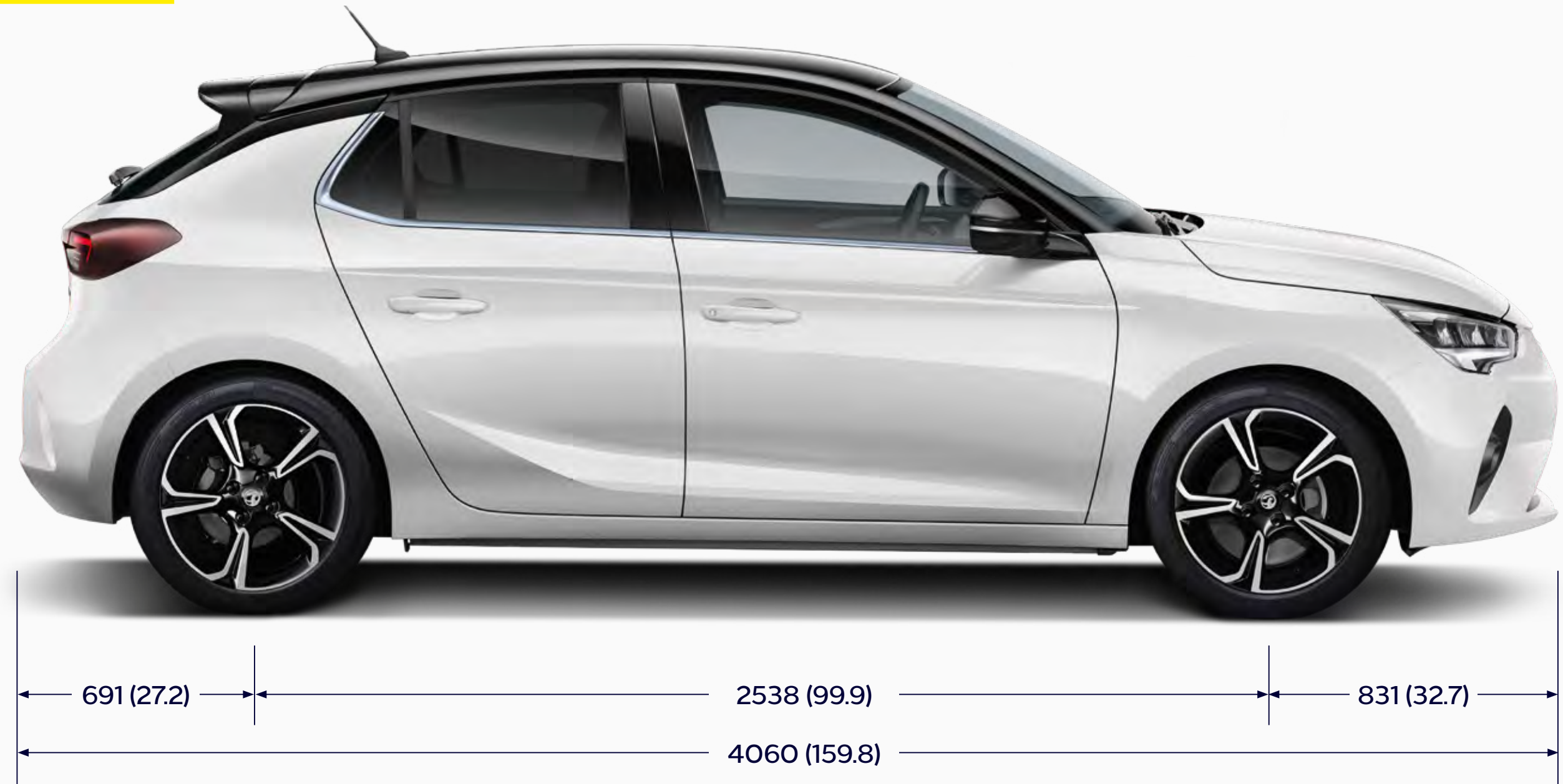

Loadspace Dimensions	Corsa	Corsa-e
Maximum length behind rear seats	885 (34.8)	885 (34.8)
Maximum length rear seats folded	1697 (66.8)	1697 (66.8)
Maximum width	867 (34.1)	867 (34.1)
Maximum height	574 (22.5)	574 (22.5)

Luggage Capacities Litres (cu.ft.)	Corsa	Corsa-e
Rear seats up (under luggage compartment cover)	309 (10.9)	267 (9.4)
Rear seats folded (to roof)	1118 (39.4)	1081 (38.1)

Accessories

Safety Total (inc. VAT)

Spare wheel kit with 15-inch emergency wheel and tool kit (petrol and diesel models only) ¹	£167
Philips ADR620 dash cam	£109
Front parking sensors	£390
Rear parking sensors	£407
Rear view camera kit	£760
Child seats ²	
– Group 0 (0-13kg) – Britax Romer Baby Safe	£239
– ISOFIX Base, Rear-facing for Britax Romer Baby Safe	£251
– Group 2/3 (15-36kg) – Britax Romer KIDFIX 2 R	£317
– Group 2/3 (15-36kg) – Britax Romer KIDFIX XP	£352
– Group 3 (22-36kg) – Booster Seat without Seatback	£76
Safety Pack – first aid kit, hi-vis vest and warning triangle	£16
Warning triangle	£9
Hi-vis safety vest – adult	£4
Hi-vis safety vest – child 3-6 years (42cm)	£4
Hi-vis safety vest – child 7-12 years (52cm)	£4
First aid kit	£15
Emergency seat belt cutter and hammer	£19
Fire extinguisher (1kg) with strap	£23
Under seat bracket for fire extinguisher ³	£48

Protection Total (inc. VAT)

Floor mats (set of 4)	
– Carpet	£33
– Rubber	£53
– Velour	£77
Rear seat cover	£40
Boot area cover	£54
Rubber boot tray	£50
Reversible boot liner (carpet/rubber)	£82
Rear bumper protection film	£37
Front and rear splash guards ⁴	£84

Comfort

USB charger – 2 front and 2 rear ports	£28
FlexConnect bracket	£20
FlexConnect hook	£37
FlexConnect coat hanger	£41
FlexConnect folding table	£102
FlexConnect iPad Mini holder	£127
FlexConnect iPad holder	£106
FlexConnect iPad Air holder	£106
FlexConnect Samsung Galaxy 10.1 holder	£127
Privacy shades for rear and side rear windows	£166
Front wind deflectors	£78
Foldable front armrest with storage	£149
Rear cup holder	£56
Cupholder organisers	£8-10
Smoker's pack	£53
Fragrance diffuser	£24
Fragrance cartridge (various)	£18
Wireless phone charger	£171

Style Total (inc. VAT)

Decal kit with roof and bonnet racing stripes, in black or white	£217
Sport pedal covers	
– Manual	£63
– Auto	£44
Body styling kit ⁴ with front and rear bumper attachments, and side skirts	£1,350
17-inch diamond-cut bi-colour alloy wheels (set of four) ³	£1,220
Centre caps	
– Hot Red or Voltaic Blue	£23
– Gloss Black	£12
Valve caps (set of 4)	
– Chrome with Vauxhall logo	£10
Available in Gloss Black, Summit White, Hot Red, Voltaic Blue or Carbon fibre-effect:	
– Exterior door mirror covers ⁵	£111
– Grille bar	£172
Wheel inserts ^{6,7}	
– Each	£20
– Set of four	£32-36
– Interior rear-view mirror covers ^{3,5,6}	£64
– Interior facia inserts ⁶	£178
– Manual gear knobs ⁸	£82

Transport solutions Total (inc. VAT)

Towing	
Tow bar with removable tow ball and 13-track wiring loom ^{3,4}	£655
Towbar socket adapter ³ – 13 to 7 pin	£30
Electric	
Mode 2 emergency charging cable (Type G – UK domestic plug)	£584
Mode 3 charging cable	
– 7.4kW	£331
– 11kW	£371
– 22kW	£438
Cable bag	£49
Mode 2 Universal Charger UK kit (22kW)	£1,555
Accessories for Universal Charger	
– Wall bracket	£105
– Bag	£65
– Safety lock	£20
– Adapter Type 2	£318
– Adapter Type 3c	£358
– Adapter (various)	£120

Please note: Prices shown are fully fitted and painted, where applicable and include VAT. Please check with your local Vauxhall Retailer for details. It is advisable to ensure your insurance policy is adequate to cover additional fitted accessories. Prices correct at time of publication.

¹Vehicle must be ordered with spare wheel fixing option (T7Y) in order to accommodate the spare wheel. ²Restrictions apply to the use of child seats, please consult your vehicle user manual or Vauxhall Retailer. ³Available on petrol and diesel models only. ⁴Not compatible with SRi models.

⁵Not available in Gloss Black. ⁶Not available in Carbon fibre-effect. ⁷Only available with 17-inch diamond-cut bi-colour alloy wheels. ⁸Available in red and blue only.

Company Car Driver and Fleet Information

Benefit in kind company car taxation*

The car benefit charge will be the car's list price (including VAT, options and accessories fitted, delivery to Retailer and number plates, but excluding Vehicle Excise Duty and new vehicle first registration fee) multiplied by the percentage charge for the CO₂ emissions band in which the car falls (see table opposite). Multiply this figure by your personal income tax rate (20%** for Basic Rate, 40%** for Higher Rate) to calculate your annual benefit in kind tax liability.

Generic example:

ELECTRIC vehicle: 0g/km CO₂

On-the-road RRP	£27,305.00
Deduct: Vehicle Excise Duty	£0.00
New vehicle first registration fee	-£55.00
Effective list price	£27,250.00
Add: Optional two-coat metallic paint	£600.00
List price for tax purposes (P11D value)	£27,850.00
Car benefit charge 2022-23 tax year (2%)	£557.00
Benefit in kind tax liability	
Basic Rate (20%) tax payer	£111.40
Higher Rate (40%) tax payer	£222.80

*Please note this Price Guide provides taxation information as a guide only. Vauxhall does not provide taxation guidance. Drivers should always take professional advice on their own tax position.
**Excludes residents of Scotland.

BiK for Scottish Residents

Effective 6 April 2018 the Scottish Government have introduced their own BiK taxation structure. This only applies to Company Car Drivers that are Scottish taxpayers. HMRC will determine whether or not an individual is a Scottish taxpayer based on where their main place of residence is.

The BiK rates for Scotland are:

- Over £12,570 - £14,732 Starter Rate 19%
- Over £14,732 - £25,688 Basic Rate 20%
- Over £25,688 - £43,662 Intermediate Rate 21%
- Over £43,662 - £150,000 Higher Rate 41%
- Above £150,000 Top Rate 46%

CO ₂ emissions (g/km)	Percentage of cars price to be taxed 2022-23 tax year
Up to 50	14%
51 - 54	15%
55 - 59	16%
60 - 64	17%
65 - 69	18%
70 - 74	19%
75 - 79	20%
80 - 84	21%
85 - 89	22%
90 - 94	23%
95 - 99	24%
100 - 104	25%
105 - 109	26%
110 - 114	27%
115 - 119	28%
120 - 124	29%
125 - 129	30%
130 - 134	31%
135 - 139	32%
140 - 144	33%
145 - 149	34%
150 - 154	35%
155 - 159	36%
160 - 164	37%
165 - 169	37%
170+	37%

CO ₂ emissions (g/km)	Electric range (miles)	Percentage of cars price to be taxed 2022-23 tax year
0	-	2%
1 - 50	130+	2%
1 - 50	70 - 129	5%
1 - 50	40 - 69	8%
1 - 50	30 - 39	12%
1 - 50	<30	14%

To calculate your own personal liability, search: **Vauxhall BiK**, or click the link below:
[Vauxhall BiK Tool](#)

Fleet Toolbox

Discover the facts in our online Toolbox for both Company Car Drivers and Fleet Decision Makers. The Fleet Toolbox has a host of useful calculators, comparators, interactive listings and information.

Search Vauxhall Fleet Tools or click the link below:
[Vauxhall Fleet Tool Box](#)

Contact Vauxhall Fleet

Please contact one of our dedicated sales teams who will be happy to help with your particular enquiry.

Company Car Drivers

Call: 0345 111 2020

Email: company-car@vauxhallinfo.co.uk

Telephone lines are open

- Monday to Friday 8:00am-9:00pm

- Saturday and Sunday 9:00am-6:00pm

Fleet Decision Makers

Depending on the size of your fleet of vehicles, we have a dedicated team to handle your enquiries. The lines are open Monday to Friday excluding Bank Holidays.

1-24 vehicles

Call: 0845 076 2254 (8:30am-5:00pm)

25+ vehicles

Call: 0330 587 8222 (8:30am-5:00pm)

Email: vauxhallfleet@vauxhall.co.uk

Special Vehicles (Police, Fire and Ambulance)

Call: 01582 409999 (8:30am-5:00pm)

Email: vauxhallspecialvehicles@vauxhall.co.uk

Further Information

On-the-road prices

To eliminate uncertainty about hidden costs when buying a new car, Vauxhall publishes on-the-road recommended retail prices (RRP) and these are shown in the pricing tables within this price guide. These prices include VAT, number plates and delivery to Retailer of £700.00 (including £116.67 VAT), 12 months' Government Vehicle Excise Duty (see opposite for details) and the DVLA new vehicle first registration fee of £55.00.*

Please note: The on-the-road recommended retail price (RRP) does not include fuel supplied by the Retailer, motor insurance or any other goods or services supplied by agreement between the Retailer and the customer.

Price protection

Order a new Vauxhall for build in the current model year (as confirmed by your Retailer) for delivery no more than three months in advance and the price you are quoted is the price you pay. This is irrespective of any subsequent price rises between placing your order and delivery of your new car, but you must take delivery as soon as the car is available.

Please note: Price protection does not apply to Mokka-e/Corsa-e/Grandland X hybrid models. Vauxhall Motors Limited is not liable for price adjustments caused by Government changes in the rate of VAT (currently 20%), Vehicle Excise Duty, DVLA new vehicle first registration fee or by any other applicable legislation or regulations.

In the event of an accident

Vauxhall Accident Management helps keep you mobile following an accident. Benefits include vehicle recovery, Vauxhall-approved repairs and contacting your insurer. For more details, visit vauxhall.co.uk/AccidentManagement

Free2Move Lease

Whether you're a big company or a small business looking for vehicle financing, Free2Move Lease, our business finance specialists, can deliver exactly what you need.

Free2Move Lease is one of the UK's largest leasing companies and is also a member of the British Vehicle Rental and Leasing Association (BVRLA).

With over 60,000 vehicles in the Free2Move Lease portfolio, Free2Move Lease is able to offer competitive vehicle solutions. In addition, Free2Move Lease also offer innovative connected management of servicing and maintenance.

For further information, please contact your local Vauxhall Retailer or visit vauxhall.co.uk/offers-finance/business-leasing.html

Vehicle Excise Duty

The amount of Vehicle Excise Duty (road fund licence) payable on new cars varies depending on the level of carbon dioxide (CO₂) emissions produced by the vehicle. CO₂ emissions are measured in grams per kilometre (g/km) travelled and divided into 13 charging bands shown in the table opposite.

A 'first year rate' of Vehicle Excise Duty is payable on all new cars and in subsequent years the amount payable reverts to the 'standard rate'. From 1 April 2017 the breakpoints for each of these bands have been revised. Also, for vehicles with a list price over £40,000, including factory-fitted options, an additional £335 is payable for the first five years of standard rate payments.

Vehicle Excise Duty*

Band	CO ₂ emissions in grams per kilometre	First year rate Petrol	Standard rate Petrol	Standard rate Electric
A	0	£0	£0	£0
B	1 – 50	£10	£165	–
C	51 – 75	£25	£165	–
D	76 – 90	£120	£165	–
E	91 – 100	£150	£165	–
F	101 – 110	£170	£165	–
G	111 – 130	£190	£165	–
H	131 – 150	£230	£165	–
I	151 – 170	£585	£165	–
J	171 – 190	£945	£165	–
K	191 – 225	£1,420	£165	–
L	226 – 255	£2,015	£165	–
M	Over 255	£2,365	£165	–

*Correct at time of issue.

Further Information

Customer Care Commitment

For added peace of mind, Vauxhall has an innovative Customer Care Commitment that offers the following:

- Three-year vehicle warranty consisting of a one-year/unlimited mileage manufacturer's warranty and a second and third year manufacturer's warranty with a 60,000 miles limitation
- Vauxhall Assistance for 12 months from first registration
- Six years' body panel anti-perforation warranty

Please note: Warranty is only available on vehicles sourced from Vauxhall Motors Limited. Terms and conditions apply – please see your Vauxhall Retailer for details.

Vauxhall Assistance

Vauxhall Assistance is provided automatically with every new Vauxhall for 12 months from first registration and covers everything from accident assistance, roadside recovery and 'at home' service to flat tyres. For even more peace of mind, on Corsa-e models the cover is extended* to 8 years or 100,000 miles, whichever comes first. Even more reason for you to stay calm and let us take care of everything should the need arise. With Vauxhall Assistance help is literally just a free** phone call away, 24 hours a day, 365 days a year!

Protecting the environment

Vauxhall's commitment to the environment is demonstrated by our products' many environmental awards. For even more information on Vauxhall's efforts to achieve an environmentally sustainable future, and how to dispose of your end-of-life vehicle, see vauxhall.co.uk/recycling

Vauxhall Care

This all-inclusive service package is available on Vauxhalls under 10 months old (from date of first registration).

This package offers complete peace of mind for the first 3 years of your Vauxhall's life with fixed monthly payments for the plan duration.

- **3 years' Vauxhall servicing** – covers first, second and third annual services. Including a brake-fluid change in the second service
- **2 years' Vauxhall Roadside Assistance** – first year from us
- **First years' MOT[†]** – free of charge by your local Vauxhall Retailer

For full terms and conditions and to sign up, visit: vauxhall.co.uk/vauxhallcare

Vauxhall Service Club

Vauxhall Service Club is available for all Vauxhall owners, and it's free to join. Members benefit from the following:

- 15% off Vauxhall Approved Accessories
- Vauxhall's aged 2-3 Years = 15% off parts and labour
- Vauxhall's aged over 3 Years = 25% off parts and labour
- Half price MOT's (NI excluded)
- Free pre-MOT test inspection (NI only)
- Fixed price AdBlue[®] Refills
 - Car = £14.99
 - Van = £24.99
- Access to the Vauxhall Accident Management Programme
- Online service booking available 24/7 with servicing appointments available within 3 days – [Book Online](#)
- Collection and delivery/onward mobility options
- Complimentary 'Wash and Vac' with all routine services^{††}
- Vauxhall trained technicians
- Genuine Vauxhall parts
- Minimum 12 months warranty on parts and labour
- Regular newsletters with exclusive offers, discounts and competitions

Terms and conditions apply. To join visit: vauxhall.co.uk/serviceclub

Vauxhall Insurance with added reassurance

Comprehensive cover – Summary of benefits

- Competitive premiums
- Repairs by a Vauxhall-trained technician
- Genuine Vauxhall parts, guaranteed for five years when we repair your car within our Approved Repairer Network
- Free courtesy car as standard when using an Approved Repairer[‡]
- 24 hour claims helpline
- Personal Accident benefit
- Cover for audio equipment
- Windscreen cover

Call for a quote on **0330 678 1130^{‡‡}**

For more product information

For further information on the Vauxhall range or location of your nearest Vauxhall Retailer please call **0345 600 1500**. Alternatively, details can be found on our website at vauxhall.co.uk

For more information call **0345 600 1500**

For Fleet enquiries call **0330 587 8222**

Discover the full Vauxhall range at **[vauxhall.co.uk](https://www.vauxhall.co.uk)**

Join us online

The invoice price, including delivery to Retailer, factory-fitted options, accessories fitted by the Retailer and number plates, is subject to VAT. Some feature descriptions in this guide may refer to, and some illustrations may show, optional equipment not included in the standard delivery. The information contained in this guide was accurate at the time of publication. We reserve the right to make changes in design and equipment. Please note that Vauxhall Retailers are not the agents of Vauxhall Motors Limited and are not authorised to bind Vauxhall Motors Limited by any specific or implied undertaking or representation. It is advisable to ensure that your motor insurance policy provides adequate cover for additional fitted options and accessories. The colours in this guide are only approximate actual colours. Illustrated optional equipment is available at extra charge. Availability, technical features and equipment provided on our vehicles can vary by model. For precise information on the equipment provided on our vehicles, please contact your local Vauxhall Retailer.

VAUXHALL

Price and Specification Guide
6 April 2022 | Model Year 2022B



All-new Astra

Including new Plug-in HYBRID-e models

Contents

To find the information you want use the links below to navigate around the guide:

Pure Technology

Choose Your Trim Level

Range Highlights

Models

Prices

PureSense

PureConnect

Comfort and Convenience

Safety and Security

Styling

Exterior Colours

Wheels and Tyres

Specifications

Dimensions and Capacities

Company Car Information

Further Information

Pure Technology

The all-new Astra is an all-round class-leading car, with an advanced Plug-in hybrid option and intuitive technology. Like IntelliLux adaptive LED[®] pixel headlights with 84 elements per headlamp, state-of-the-art driver assistance systems and the new fully digital 'Pure Panel' dashboard.

Vauxhall Pure Technology

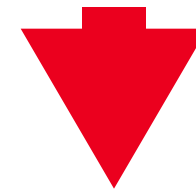

Vauxhall PureEnergy

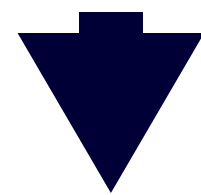

All-new Astra Plug-in HYBRID-e.

- Plug-in Hybrid
- Up to 43 miles electric-only range
- Smooth 8-speed electrified automatic transmission

Vauxhall PureSense

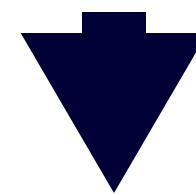

Intelligent automotive technology that's designed to give you unparalleled command and control of your every journey.

- IntelliLux adaptive LED[®] pixel headlights
- Intelli-Vision 360[°] panoramic parking camera
 - Adaptive cruise control
 - Lane positioning assist
 - Rear cross traffic alert

Vauxhall PureConnect

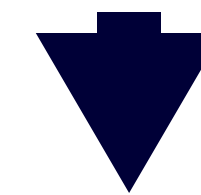

Intuitive connectivity that makes it simple to stay in touch, informed and entertained throughout day.

- Pure Panel
- Wireless phone projection
- Wireless phone charging
- Natural voice recognition
 - Vauxhall Connect

Choose Your Trim Level

Design



Inject a little excitement into your commute with the Design, including plenty of 'must have' features as standard.

GS Line



Step up to our sporty GS Line. It's kitted out with a whole host of features that make it fun to drive, and great to look at.

Also available as a Plug-in HYBRID-e model.

Ultimate



All you could ask for; our Ultimate model has it all.

Also available as a Plug-in HYBRID-e model.*

*Hatchback model only.

All-new Astra Plug-in HYBRID-e Range Highlights

GS Line

Standard features include:

PureSense

- LED headlights and tail lights
- LED daytime running lights
- LED front fog lights
- High beam assist
- Electronic parking brake
- Front and rear parking distance sensors
- Lane departure warning with lane keep assist
- Traffic sign recognition
- Driver drowsiness alert
- Forward collision alert (all speed)
- Automatic emergency braking with pedestrian detection
- Adaptive cruise control with intelligent speed adaptation
- Eight airbags
- Remote control security alarm system
- Hill start assist
- ISOFIX child seat fixings on outer rear seats
- In-crash braking
- Intelli-Vision 360° panoramic parking camera

PureConnect

- Multimedia Pure Panel Navigation system
 - 10-inch colour touchscreen
 - 10-inch digital instrument cluster
 - AM/FM/DAB digital radio
 - Bluetooth®
 - Natural voice recognition**
 - Wireless Apple CarPlay/Android Auto™
 - 2 x front USB connections
- Six speakers
- Vauxhall Connect

Comfort and Convenience

- Dual-zone electronic climate control
- Heated perforated flat-bottomed leather-covered steering wheel
- Steering wheel audio/phone/cruise controls
- Interior ambient lighting
- 60/40 split-folding rear seat backs (Hatchback only)
- 40/20/40 split-folding rear seat backs (Sports Tourer only)
- Fixed floor with luggage restraining nets (pair, Sports Tourer only)
- Rain-sensitive windscreen wipers
- Electrically operated front and rear windows
- Electrically adjustable/heated power folding door mirrors with puddle light
- Soundproofed insulated windscreen
- Driver's ergonomic active seat (AGR approved*)
- Heated sports-style front seats
- Paddle shift
- Front centre armrest with cup holder
- Centre rear seat armrest and load-through facility
- Frameless automatic anti-dazzle rear-view mirror
- Keyless entry and start
- Intelli-Space (Sports Tourer only. See page 24 for more information)

Styling

- Sports-style front and rear bumpers
- 17-inch black alloy wheels
- Black Griffin logo and vizzor frame
- Black lower window moulding
- Dark-tinted rear windows
- Black roof
- Black headliner
- Alloy-effect sports pedals
- Silver-effect roof rails (Sports Tourer only)

Ultimate

Features over GS Line models:

PureSense

- IntelliLux adaptive LED® pixel headlights
- Lane change assist with side blind spot alert
- Lane positioning assist
- Rear cross traffic alert

PureConnect

- Intelli-HUD (Head-Up Display)
- Wireless charger for mobile devices
- Eight speakers

Comfort and Convenience

- Dual-zone electronic climate control with Intelli-Air (air quality sensor)
- Heated soundproofed insulated windscreen
- Heated ergonomic active sports-style front seats (AGR approved*)
- Alcantara interior seat trim
- Panoramic sunroof

Styling

- 18-inch grey diamond-cut alloy wheels

All-new Astra Range Highlights

Design

Standard features include:

PureSense

- LED headlights and tail lights
- LED daytime running lights
- LED front fog lights
- High beam assist
- Electronic parking brake
- Front and rear parking distance sensors
- Lane departure warning with lane keep assist
- Speed sign recognition
- Driver drowsiness alert
- Forward collision alert (low speed)
- Automatic emergency braking with pedestrian detection
- Cruise control with intelligent speed adaption
- Eight airbags
- Remote control security alarm system
- Hill start assist
- ISOFIX child seat fixings on outer rear seats
- In-crash braking

PureConnect

- Multimedia Pure Panel Navigation system
 - 10-inch colour touchscreen
 - 10-inch digital instrument cluster
 - AM/FM/DAB digital radio
 - Bluetooth®
 - Natural voice recognition**
 - Wireless Apple CarPlay/Android Auto™
 - Front USB connection
- Six speakers
- Vauxhall Connect

Comfort and Convenience

- Electronic climate control
- Flat-bottomed leather-covered steering wheel
- Steering wheel audio/phone/cruise controls
- 60/40 split-folding rear seat backs (Hatchback only)
- 40/20/40 split-folding rear seat backs with remote easy-fold facility (Sports Tourer only)
- Flex load floor with luggage restraining nets (pair, Sports Tourer only)
- Rain-sensitive windscreen wipers
- Electrically operated front and rear windows
- Electrically adjustable/heated door mirrors
- Soundproofed insulated windscreen
- Keyless start
- Intelli-Space (Sports Tourer only. See page 24 for more information)

Styling

- Body-colour front and rear bumpers
- 16-inch silver alloy wheels
- Chrome-effect Griffin logo and vizer frame
- Black lower window moulding

GS Line

Features over Design models:

PureSense

- Traffic sign recognition
- Forward collision alert (all speed)
- Adaptive cruise control with intelligent speed adaption

PureConnect

- Intelli-Vision 360° panoramic parking camera

Comfort and Convenience

- Dual-zone electronic climate control
- Heated perforated flat-bottomed leather-covered steering wheel
- Driver's ergonomic active sports-style seat (AGR approved*)
- Heated front seats
- Paddle shift (auto models only)
- Front centre armrest with cup holder
- Centre rear seat armrest and load-through facility
- Flex load floor
- Frameless automatic anti-dazzle rear-view mirror
- Keyless entry and start
- Interior ambient lighting

Styling

- Sports-style front and rear bumpers
- 17-inch black alloy wheels
- Black Griffin logo and vizer frame
- Dark-tinted rear windows
- Black roof • Black headliner
- Alloy-effect sports pedals
- Silver-effect roof rails (Sports Tourer only)

Ultimate

Features over GS Line models:

PureSense

- IntelliLux adaptive LED® pixel headlights
- Lane change assist with side blind spot alert
- Lane positioning assist
- Rear cross traffic alert

PureConnect

- Eight speakers
- Intelli-HUD (Head-Up Display)
- Wireless charger for mobile devices

Comfort and Convenience

- Dual-zone electronic climate control with Intelli-Air (air quality sensor)
- Heated soundproofed insulated windscreen
- Heated ergonomic active sports-style front seats (AGR approved*)
- Alcantara interior seat trim
- Panoramic sunroof

All-new Astra GS Line Plug-in HYBRID-e

VX_AST_PHEV_33014



GS Line OTR from £32,700

PureSense

- LED headlights and tail lights
- LED daytime running lights
- LED front fog lights
- High beam assist
- Electronic parking brake
- Front and rear parking distance sensors
- Lane departure warning with lane keep assist
- Traffic sign recognition
- Driver drowsiness alert
- Forward collision alert (all speed)
- Automatic emergency braking with pedestrian detection
- Adaptive cruise control with intelligent speed adaption
- Eight airbags
- Hill start assist
- ISOFIX child seat fixings on outer rear seats
- In-crash braking
- Intelli-Vision 360° panoramic parking camera

PureConnect

- Multimedia Pure Panel Navigation system
 - 10-inch colour touchscreen
 - 10-inch digital instrument cluster
 - AM/FM/DAB digital radio
 - Bluetooth®
 - Natural voice recognition
 - Wireless Apple CarPlay/Android Auto™
 - 2 x front USB connections
- Six speakers • Vauxhall Connect

Comfort and Convenience

- Dual-zone electronic climate control
- Heated perforated flat-bottomed leather-covered steering wheel

- Steering wheel audio/phone/cruise controls
- Interior ambient lighting
- 60/40 split-folding rear seat backs (Hatchback only)
- 40/20/40 split-folding rear seat backs (Sports Tourer only)
- Fixed floor with luggage restraining nets (pair, Sports Tourer only)
- Rain-sensitive windscreen wipers
- Electrically operated front and rear windows
- Electrically adjustable/heated power folding door mirrors with puddle light
- Soundproofed insulated windscreen
- Driver's ergonomic active seat (AGR approved*)
- Heated sports-style front seats
- Paddle shift
- Front centre armrest with cup holder
- Centre rear seat armrest and load-through facility
- Frameless automatic anti-dazzle rear-view mirror
- Remote control security alarm system
- Keyless entry and start
- Intelli-Space (Sports Tourer only. See page 24 for more information)

Styling

- Sports-style front and rear bumpers
- 17-inch black alloy wheels
- Black Griffin logo and vizer frame
- Black lower window moulding
- Dark-tinted rear windows
- Black roof
- Black headliner
- Alloy-effect sports pedals
- Silver-effect roof rails (Sports Tourer only)

All-new Astra Ultimate Plug-in HYBRID-e

VX_AST_PHEV_32918



Ultimate

OTR from £35,815

PureSense

- IntelliLux adaptive LED® pixel headlights and LED tail lights
- LED daytime running lights
- LED front fog lights
- High beam assist
- Electronic parking brake
- Front and rear parking distance sensors
- Lane departure warning with lane keep assist
- Traffic sign recognition
- Driver drowsiness alert
- Forward collision alert (all speed)
- Automatic emergency braking with pedestrian detection
- Adaptive cruise control
- Eight airbags
- Hill start assist
- ISOFIX child seat fixings on outer rear seats
- In-crash braking
- Intelli-Vision 360° panoramic parking camera
- Lane change assist with side blind spot alert
- Lane positioning assist
- Rear cross traffic alert

PureConnect

- Multimedia Pure Panel Navigation system
 - 10-inch colour touchscreen
 - 10-inch digital instrument cluster
 - AM/FM/DAB digital radio
 - Bluetooth®
 - Natural voice recognition
 - Wireless Apple CarPlay/Android Auto™
 - 2 x front USB connections
- Eight speakers • Vauxhall Connect
- Intelli-HUD (Head-Up Display)
- Wireless charger for mobile devices

Comfort and Convenience

- Dual-zone electronic climate control with Intelli-Air (air quality sensor)
- Heated perforated flat-bottomed leather-covered steering wheel
- Steering wheel audio/phone/cruise controls
- Interior ambient lighting
- 60/40 split-folding rear seat backs
- Rain-sensitive windscreen wipers
- Electrically operated front and rear windows
- Electrically adjustable/heated power folding door mirrors with puddle light
- Heated soundproofed insulated windscreen
- Heated ergonomic active sports-style front seats (AGR approved*)
- Paddle shift
- Front centre armrest with cup holder
- Centre rear seat armrest and load-through facility
- Frameless automatic anti-dazzle rear-view mirror
- Alcantara interior seat trim
- Remote control security alarm system
- Keyless entry and start
- Panoramic sunroof

Styling

- Sports-style front and rear bumpers
- 18-inch grey diamond-cut alloy wheels
- Black Griffin logo and vizer frame
- Black lower window moulding
- Dark-tinted rear windows
- Black roof
- Black headliner
- Alloy-effect sports pedals

All-new Astra Design

VX_AST_32915



Design

OTR from £24,315

PureSense

- LED headlights and tail lights
- LED daytime running lights
- LED front fog lights
- High beam assist
- Electronic parking brake
- Front and rear parking distance sensors
- Lane departure warning with lane keep assist
- Speed sign recognition
- Driver drowsiness alert
- Forward collision alert (low speed)
- Automatic emergency braking with pedestrian detection
- Cruise control with intelligent speed adaptation
- Eight airbags
- Hill start assist
- ISOFIX child seat fixings on outer rear seats
- In-crash braking

PureConnect

- Multimedia Pure Panel Navigation system
 - 10-inch colour touchscreen
 - 10-inch digital instrument cluster
 - AM/FM/DAB digital radio
 - Bluetooth®
 - Natural voice recognition
 - Wireless Apple CarPlay/Android Auto™
 - Front USB connection
- Six speakers
- Vauxhall Connect

Comfort and Convenience

- Electronic climate control
- Flat-bottomed leather-covered steering wheel
- Steering wheel audio/phone/cruise controls
- 60/40 split-folding rear seat backs (Hatchback only)
- 40/20/40 split-folding rear seat backs with remote easy-fold facility (Sports Tourer only)
- Flex load floor with luggage restraining nets (pair, Sports Tourer only)
- Rain-sensitive windscreen wipers
- Electrically operated front and rear windows
- Electrically adjustable/heated door mirrors
- Soundproofed insulated windscreen
- Remote control security alarm system
- Keyless start
- Intelli-Space (Sports Tourer only. See page 24 for more information)

Styling

- Body-colour front and rear bumpers
- 16-inch silver alloy wheels
- Chrome-effect Griffin logo and vizor frame
- Black lower window moulding

All-new Astra GS Line

VX_AST_32917



GS Line

OTR from £27,210

PureSense

- LED headlights and tail lights
- LED daytime running lights
- LED front fog lights
- High beam assist
- Electronic parking brake
- Front and rear parking distance sensors
- Lane departure warning with lane keep assist
- Traffic sign recognition
- Driver drowsiness alert
- Forward collision alert (all speed)
- Automatic emergency braking with pedestrian detection
- Adaptive cruise control with intelligent speed adaptation
- Eight airbags
- Hill start assist
- ISOFIX child seat fixings on outer rear seats
- In-crash braking
- Intelli-Vision 360° panoramic parking camera

PureConnect

- Multimedia Pure Panel Navigation system
 - 10-inch colour touchscreen
 - 10-inch digital instrument cluster
 - AM/FM/DAB digital radio
 - Bluetooth®
 - Natural voice recognition
 - Wireless Apple CarPlay/Android Auto™
 - 2 x front USB connections
- Six speakers
- Vauxhall Connect

Comfort and Convenience

- Dual-zone electronic climate control
- Heated perforated flat-bottomed leather-covered steering wheel

- Steering wheel audio/phone/cruise controls
- Interior ambient lighting
- 60/40 split-folding rear seat backs (Hatchback only)
- 40/20/40 split-folding rear seat backs with remote easy-fold facility (Sports Tourer only)
- Flex load floor with luggage restraining nets (pair, Sports Tourer only)
- Rain-sensitive windscreen wipers
- Electrically operated front and rear windows
- Electrically adjustable/heated power folding door mirrors with puddle light
- Soundproofed insulated windscreen
- Driver's ergonomic active sports-style seat (AGR approved*)
- Heated front seats
- Paddle shift (auto models only)
- Front centre armrest with cup holder
- Centre rear seat armrest and load-through facility
- Flex load floor
- Frameless automatic anti-dazzle rear-view mirror
- Remote control security alarm system
- Keyless entry and start
- Intelli-Space (Sports Tourer only. See page 24 for more information)

Styling

- Sports-style front and rear bumpers
- 17-inch black alloy wheels
- Black Griffin logo and vizer frame
- Black lower window moulding
- Dark-tinted rear windows
- Black roof
- Black headliner
- Alloy-effect sports pedals
- Silver-effect roof rails (Sports Tourer only)

All-new Astra Ultimate

VX_AST_32919



Ultimate OTR from £30,325

PureSense

- IntelliLux adaptive LED® pixel headlights and LED tail lights
- LED daytime running lights
- LED front fog lights
- High beam assist
- Electronic parking brake
- Front and rear parking distance sensors
- Lane departure warning with lane keep assist
- Traffic sign recognition
- Driver drowsiness alert
- Forward collision alert (all speed)
- Adaptive cruise control
- Automatic emergency braking with pedestrian detection
- Eight airbags
- Hill start assist
- ISOFIX child seat fixings on outer rear seats
- In-crash braking
- Intelli-Vision 360° panoramic parking camera
- Lane change assist with side blind spot alert
- Lane positioning assist
- Rear cross traffic alert

PureConnect

- Multimedia Pure Panel Navigation system
 - 10-inch colour touchscreen
 - 10-inch digital instrument cluster
 - AM/FM/DAB digital radio
 - Bluetooth®
 - Natural voice recognition
 - Wireless Apple CarPlay/Android Auto™
 - 2 x front USB connections
- Eight speakers • Vauxhall Connect
- Intelli-HUD (Head-Up Display)
- Wireless charger for mobile devices

Comfort and Convenience

- Dual-zone electronic climate control with Intelli-Air (air quality sensor)
- Heated perforated flat-bottomed leather-covered steering wheel
- Steering wheel audio/phone/cruise controls
- Interior ambient lighting
- 60/40 split-folding rear seat backs
- Rain-sensitive windscreen wipers
- Electrically operated front and rear windows
- Electrically adjustable/heated power folding door mirrors with puddle light
- Heated soundproofed insulated windscreen
- Heated ergonomic active sports-style front seats (AGR approved*)
- Paddle shift (auto models only)
- Front centre armrest with cup holder
- Centre rear seat armrest and load-through facility
- Flex load floor
- Frameless automatic anti-dazzle rear-view mirror
- Alcantara interior seat trim
- Remote control security alarm system
- Keyless entry and start
- Panoramic sunroof

Styling

- Sports-style front and rear bumpers
- 18-inch grey diamond-cut alloy wheels
- Black Griffin logo and vizer frame
- Black lower window moulding
- Dark-tinted rear windows
- Black roof
- Black headliner
- Alloy-effect sports pedals

All-new Astra Hatchback Plug-in HYBRID-e Prices

	Pack Code	Fuel Type	Price (£)	VAT (£)	Total (£)	On-the-road RRP (£)	Financial Year 2022/23 BiK 20% (£)	WLTP Combined CO ₂ (g/km)* - pack code	Insurance groups
GS Line									
1.6 (180PS) Turbo/Electric auto	EF48 IL81	Petrol/Electric	26,620.84	5,324.17	31,945.00	32,700.00	43.52	24	26P
Ultimate									
1.6 (180PS) Turbo/Electric auto	EH48 IL81	Petrol/Electric	29,216.67	5,843.33	35,060.00	35,815.00	47.67	25	28P

All-new Astra Sports Tourer Plug-in HYBRID-e Prices

	Pack Code	Fuel Type	Price (£)	VAT (£)	Total (£)	On-the-road RRP (£)	Financial Year 2022/23 BiK 20% (£)	WLTP Combined CO ₂ (g/km)* - pack code	Insurance groups
GS Line									
1.6 (180PS) Turbo/Electric auto	EF35 IL81	Petrol/Electric	27,620.84	5,524.17	33,145.00	33,900.00	45.12	25	27P

WLTP Combined CO₂ (g/km) figures are based on a configured vehicle as per pack code for UK with no options fitted.

*Fuel consumption and CO₂ figures are determined according to the WLTP test cycle. CO₂ figures, BiK values and RRP pricing shown above are for a standard vehicle without any additional optional equipment. CO₂ figures are used to calculate Vehicle Excise Duty (VED) for the first registration of the vehicle and BiK. The addition of optional extras could increase the certified CO₂ emission output. This in turn may affect the amount of VED payable upon registration, and, for company car drivers, the P11D value and the amount of Benefit in Kind (BiK) tax payable. Figures shown are for comparison purposes and should only be compared to the fuel consumption and CO₂ values of other cars tested to the same technical standard. The fuel consumption achieved, and CO₂ produced, in real world conditions will depend upon a number of factors including, but not limited to: the accessories fitted (pre and post registration); variations in weather; driving styles and vehicle load. The WLTP (Worldwide Harmonised Light Vehicles Test Procedure) is used to measure fuel consumption and CO₂ figures. Full data relating to WLTP test cycles can be found at: www.vauxhall.co.uk/wltp

Please note: On-the-road recommended retail prices (RRP) include number plates and delivery to Retailer of £700.00 (inc. £116.67 VAT), 12 months' Vehicle Excise Duty and new vehicle first registration fee of £55.00. Excludes fuel and insurance. Company Car Benefit in Kind (BiK) rates are monthly based on the standard paint price.

All-new Astra Hatchback Prices

	Pack Code	Fuel Type	Price (£)	VAT (£)	Total (£)	On-the-road RRP (£)	Financial Year 2022/23 BiK 20% (£)	WLTP Combined CO ₂ (g/km) [#] – pack code	Insurance groups
Design									
1.2 (110PS) Turbo	EB48 EL61	Petrol	19,475.00	3,895.00	23,370.00	24,315.00	116.33	123	16P
1.2 (130PS) Turbo	EB48 EK61	Petrol	19,975.00	3,995.00	23,970.00	24,915.00	119.23	123	17P
1.2 (130PS) Turbo auto	EB48 EO81	Petrol	21,225.00	4,245.00	25,470.00	26,415.00	130.85	126	18P
1.5 (130PS) Turbo D	EB48 HI61	Diesel	20,808.34	4,161.67	24,970.00	25,915.00	115.50	114	18P
1.5 (130PS) Turbo D auto	EB48 HJ81	Diesel	22,058.34	4,411.67	26,470.00	27,415.00	126.78	118	19P
GS Line									
1.2 (130PS) Turbo	EF48 EK61	Petrol	21,887.50	4,377.50	26,265.00	27,210.00	130.32	124	18P
1.2 (130PS) Turbo auto	EF48 EO81	Petrol	23,137.50	4,627.50	27,765.00	28,710.00	142.32	127	18P
1.5 (130PS) Turbo D	EF48 H161	Diesel	22,720.84	4,544.17	27,265.00	28,210.00	130.50	115	18P
1.5 (130PS) Turbo D auto	EF48 HJ81	Diesel	23,970.84	4,794.17	28,765.00	29,710.00	137.50	118	18P
Ultimate									
1.2 (130PS) Turbo	EH48 EK61	Petrol	24,483.34	4,896.67	29,380.00	30,325.00	150.40	126	20P
1.2 (130PS) Turbo auto	EH48 EO81	Petrol	25,733.34	5,146.67	30,880.00	31,825.00	157.90	128	21P
1.5 (130PS) Turbo D	EH48 H161	Diesel	25,316.67	5,063.33	30,380.00	31,325.00	145.03	116	20P
1.5 (130PS) Turbo D auto	EH48 HJ81	Diesel	26,566.67	5,313.33	31,880.00	32,825.00	157.47	120	21P

All-new Astra's petrol and diesel engines meet the Real Driving Emissions Step 2 (RDE2) standards.

WLTP Combined CO₂ (g/km) figures are based on a configured vehicle as per pack code for UK with no options fitted.

[#]Fuel consumption and CO₂ figures are determined according to the WLTP test cycle. CO₂ figures, BiK values and RRP pricing shown above are for a standard vehicle without any additional optional equipment. CO₂ figures are used to calculate Vehicle Excise Duty (VED) for the first registration of the vehicle and BiK. The addition of optional extras could increase the certified CO₂ emission output. This in turn may affect the amount of VED payable upon registration, and, for company car drivers, the P11D value and the amount of Benefit in Kind (BiK) tax payable. Figures shown are for comparison purposes and should only be compared to the fuel consumption and CO₂ values of other cars tested to the same technical standard. The fuel consumption achieved, and CO₂ produced, in real world conditions will depend upon a number of factors including, but not limited to: the accessories fitted (pre and post registration); variations in weather; driving styles and vehicle load. The WLTP (Worldwide Harmonised Light Vehicles Test Procedure) is used to measure fuel consumption and CO₂ figures. Full data relating to WLTP test cycles can be found at: www.vauxhall.co.uk/wltp

Please note: On-the-road recommended retail prices (RRP) include number plates and delivery to Retailer of £700.00 (inc. £116.67 VAT), 12 months' Vehicle Excise Duty and new vehicle first registration fee of £55.00. Excludes fuel and insurance. Company Car Benefit in Kind (BiK) rates are monthly based on the standard paint price.

All-new Astra Sports Tourer Prices

	Pack Code	Fuel Type	Price (£)	VAT (£)	Total (£)	On-the-road RRP (£)	Financial Year 2022/23 BiK 20% (£)	WLTP Combined CO ₂ (g/km) [#] – pack code	Insurance groups
Design									
1.2 (110PS) Turbo	EB35 EL61	Petrol	20,475.00	4,095.00	24,570.00	25,515.00	126.35	126	16P
1.2 (130PS) Turbo	EB35 EK61	Petrol	20,975.00	4,195.00	25,170.00	26,115.00	129.35	126	18P
1.2 (130PS) Turbo auto	EB35 EO81	Petrol	22,225.00	4,445.00	26,670.00	27,615.00	136.85	128	19P
1.5 (130PS) Turbo D	EB35 H161	Diesel	21,808.34	4,361.67	26,170.00	27,115.00	125.38	116	20P
1.5 (130PS) Turbo D auto	EB35 HJ81	Diesel	23,058.34	4,611.67	27,670.00	28,615.00	132.38	119	19P
GS Line									
1.2 (130PS) Turbo	EF35 EK61	Petrol	22,887.50	4,577.50	27,465.00	28,410.00	140.82	128	18P
1.2 (130PS) Turbo auto	EF35 EO81	Petrol	24,137.50	4,827.50	28,965.00	29,910.00	153.27	130	19P
1.5 (130PS) Turbo D	EF35 H161	Diesel	23,720.84	4,744.17	28,465.00	29,410.00	136.10	117	20P
1.5 (130PS) Turbo D auto	EF35 HJ81	Diesel	24,970.84	4,994.17	29,965.00	30,910.00	148.20	120	21P

All-new Astra's petrol and diesel engines meet the Real Driving Emissions Step 2 (RDE2) standards.

WLTP Combined CO₂ (g/km) figures are based on a configured vehicle as per pack code for UK with no options fitted.

[#]Fuel consumption and CO₂ figures are determined according to the WLTP test cycle. CO₂ figures, BiK values and RRP pricing shown above are for a standard vehicle without any additional optional equipment. CO₂ figures are used to calculate Vehicle Excise Duty (VED) for the first registration of the vehicle and BiK. The addition of optional extras could increase the certified CO₂ emission output. This in turn may affect the amount of VED payable upon registration, and, for company car drivers, the P11D value and the amount of Benefit in Kind (BiK) tax payable. Figures shown are for comparison purposes and should only be compared to the fuel consumption and CO₂ values of other cars tested to the same technical standard. The fuel consumption achieved, and CO₂ produced, in real world conditions will depend upon a number of factors including, but not limited to: the accessories fitted (pre and post registration); variations in weather; driving styles and vehicle load. The WLTP (Worldwide Harmonised Light Vehicles Test Procedure) is used to measure fuel consumption and CO₂ figures. Full data relating to WLTP test cycles can be found at: www.vauxhall.co.uk/wltp

Please note: On-the-road recommended retail prices (RRP) include number plates and delivery to Retailer of £700.00 (inc. £116.67 VAT), 12 months' Vehicle Excise Duty and new vehicle first registration fee of £55.00. Excludes fuel and insurance. Company Car Benefit in Kind (BiK) rates are monthly based on the standard paint price.

PureSense

PureSense Features – The following features are available across the all-new Astra range. Specific features by model are outlined in the separate tabular information.

Automatic emergency braking with pedestrian detection

Front camera system

Monitors the traffic situation in front of the vehicle using the front camera to detect mobile and fixed cars as well as adult pedestrians. The system first warns you through a series of visual and audible alerts and should you not react quickly enough, will automatically brake the vehicle to avoid or mitigate the impact of front-end collisions.*

Front camera and radar system – Standard on Ultimate models only

Adds radar-based technology, enabling you to avoid or mitigate the impact of front-end collisions by detecting fixed and mobile objects, such as cycles and pedestrians. The system will even bring the vehicle to a complete standstill when driving under 30mph in traffic

*Cycles, motorcycles, animals and other objects are not detected.

Cruise control with intelligent speed adaption

With steering wheel mounted controls. Enables you to maintain a constant speed, making it ideal for economical motorway driving.

Driver drowsiness alert

The system monitors driving time and driving behaviour to help prevent accidents caused by tiredness.

Lane departure warning with lane keep assist

If the driver has not actively steered or signalled, the lane departure warning system warns when the car moves outside of lane markings at speeds above 37mph.

- Warning light in instrument cluster
- Audible warning
- Facia on/off switch

Electronic parking brake

Centre console switch in lieu of handbrake lever.

Parking distance sensors

Ultrasonic front and rear parking sensors detect and display the distance between the rear of the vehicle and external objects as well as the vehicle's overall position. A camera is mounted in the tailgate above the registration plate and provides video assistance for reverse parking.

Please note, Vauxhall driver assistance systems are intended to support the driver within the system-imminent limitations. The driver remains responsible for the driving task at all times.



Automatic emergency braking with pedestrian protection.



Lane departure warning with lane keep assist.

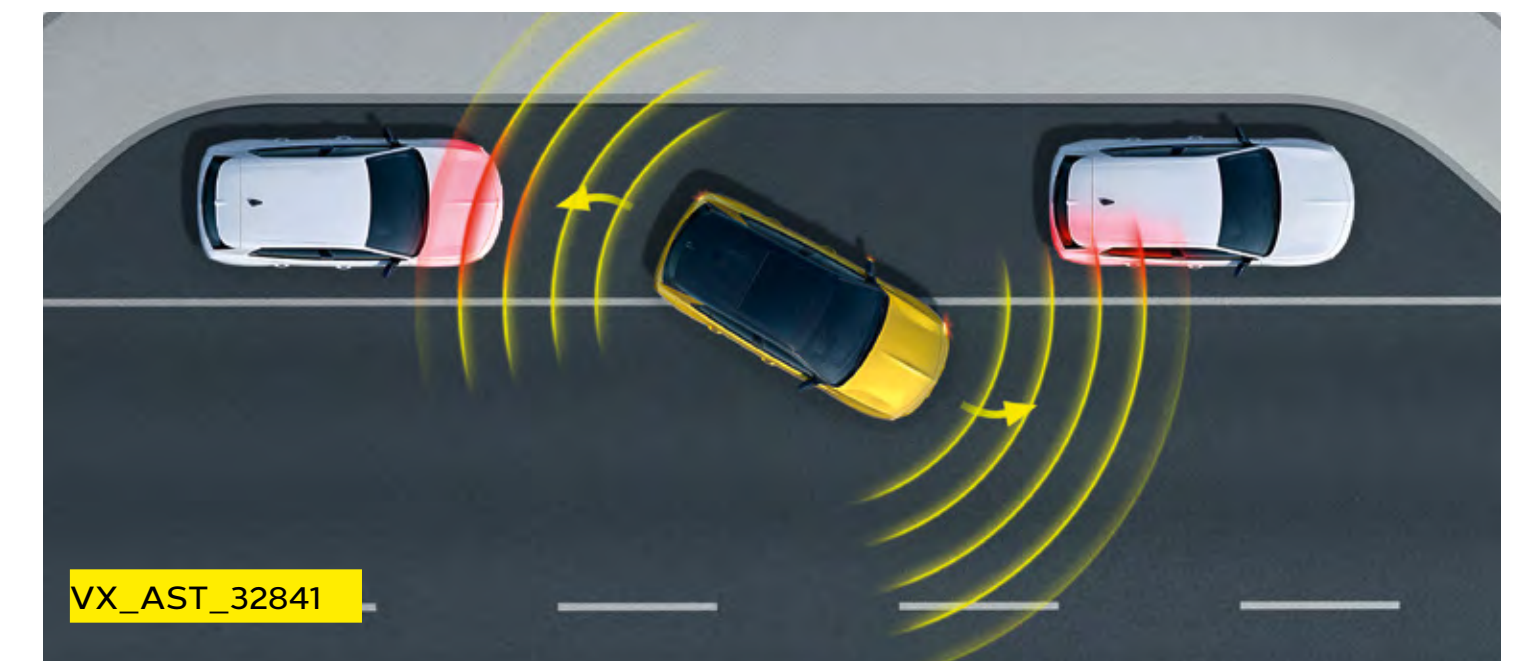

Parking distance sensors.

PureSense Features – The following features are available across the all-new Astra range.
Specific features by model are outlined in the separate tabular information.

Speed sign recognition

Detects and then displays speed limits, reducing uncertainty and the risk of speeding.

- Recognises different speed signs, including temporary speed restrictions
- Displays reminder in the instrument cluster
- When the front camera system is unable to detect any speed signs the speed limit stored in the navigation database will be displayed

Extended traffic sign recognition

This system is an evolution of standard speed sign recognition. As well as speed signs, it recognises most other traffic signs by using the front camera and displays them on the driver information cluster within the Pure Panel.

Adaptive cruise control

Adaptive cruise control uses the radar system to adjust the vehicle's speed to maintain a safe distance from the vehicle ahead, up to the speed limit set. To overtake, the driver just has to pull out into an empty lane and the system will return the car to the set speed just like normal cruise control. Also with automatic models, the system also enables the car to follow the vehicle in front from a full stop when in a traffic jam. To restart just press the 'resume' button or use the accelerator.

Intelli-Vision

Intelli-Vision is a video assistance function for all low-speed manoeuvres. It uses four cameras (front/rear/lateral in door mirrors) and is activated automatically when the car is put into reverse. It can also be activated manually by the driver. The full-HD cameras show real-time images of the surroundings to avoid collisions during parking manoeuvres.

360° rear-view operation:

- When parking, the car and its surroundings are automatically displayed within the central Pure Panel infotainment display
- When driving under 12mph, the view from the camera corresponding to the direction of travel is displayed
- Active guide lines, controlled by the steering wheel, provide a visual prediction of the vehicle direction
- The system automatically switches between front camera view and top front/rear view according to the distance to obstacles

Please note, Vauxhall driver assistance systems are intended to support the driver within the system-imminent limitations. The driver remains responsible for the driving task at all times.



Speed sign recognition.



Adaptive cruise control.



Intelli-Vision.

PureSense Features – The following features are available across the all-new Astra range.
Specific features by model are outlined in the separate tabular information.

Intelli-Drive 1.0 (Includes the following three features):

Lane change assist with side blind spot alert

This system is radar-based and uses ultrasonic rear bumper sensors to detect a vehicle in your blind spot. The ultrasonic sensors work up to a 75 metre range, even detecting vehicles approaching at high speeds, making changing lanes safer.

Lane positioning assist

This works as a semi-automatic system that helps you integrate into a motorway lane, follow a particular lane, or follow a vehicle ahead. Engaged at the touch of a button, you can retake control from the system at any time simply by moving the steering wheel or braking to cancel.

Rear cross traffic alert

Rear cross traffic alert is radar-based and uses rear bumper sensors to detect moving objects to the rear sides of the vehicle when reversing. The system is able to detect cars, trucks, motorcycles, bicycles and pedestrians.

IntelliLux adaptive LED[®] pixel headlights

With 84 segments per headlight (168 in total), the new IntelliLux adaptive LED[®] pixel light system offers vastly improved visibility that helps to make night time driving significantly safer. The system automatically adapts the headlights according to the type of road or driving conditions in both dipped and full beam modes. There are 11 variations to ensure the correct lighting pattern for driving in a city street or country lane, cornering, parking or negotiating a tight bend. There's even a tourist mode for driving your car on European roads.

Please note, Vauxhall driver assistance systems are intended to support the driver within the system-imminent limitations. The driver remains responsible for the driving task at all times.

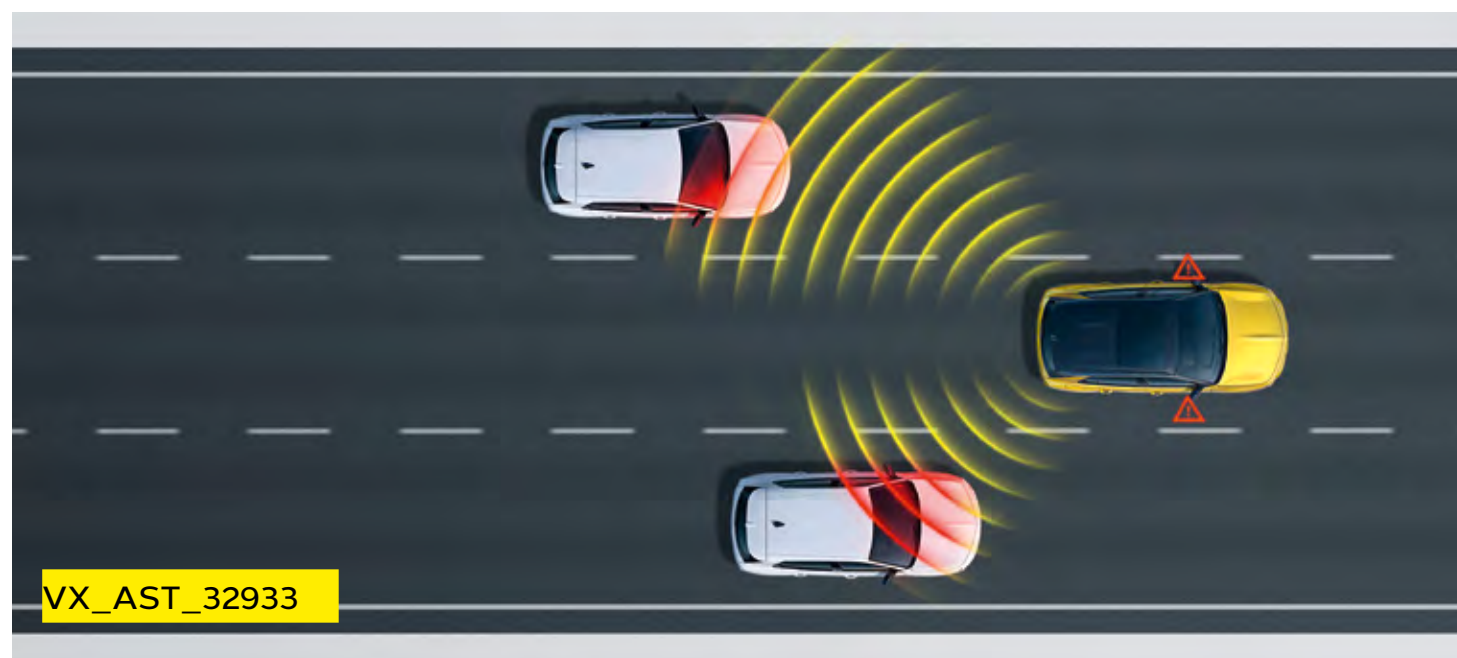

Lane change assist with side blind spot alert.

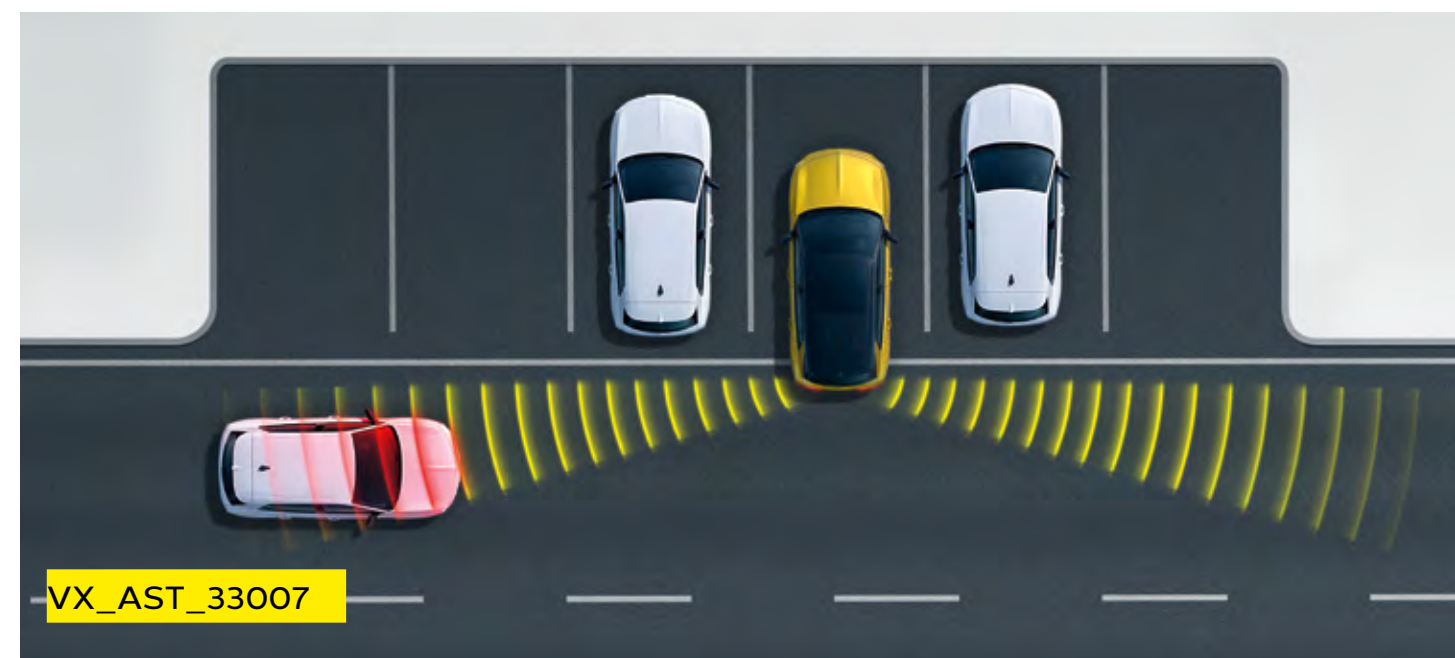

Rear cross traffic alert.



IntelliLux adaptive LED[®] pixel headlights.

Model Specific Features

	Plug-in HYBRID-e models				
	GS Line	Ultimate	Design	GS Line	Ultimate
Driver Assistance					
Automatic emergency braking with pedestrian detection	●	●	●	●	●
Cruise control with intelligent speed adaptation	●	●	●	●	●
Driver drowsiness alert	●	●	●	●	●
Lane departure warning with lane keep assist	●	●	●	●	●
Electronic parking brake	●	●	●	●	●
Front and rear parking distance sensors	●	●	●	●	●
Speed sign recognition	●	●	●	●	●
Extended traffic sign recognition	●	●		●	●
Intelli-Vision 360° panoramic parking camera	●	●		●	●
Adaptive cruise control	●	●		●	●
Intelli-HUD (Head-Up Display)		●			●
Intelli-Drive 1.0 – Lane change assist with side blind spot alert/ Lane positioning assist/Rear cross traffic alert		●			●
Exterior Lighting					
LED headlights, front fog and tail lights	●	●	●	●	●
High beam assist	●	●	●	●	●
LED daytime running lights	●	●	●	●	●
Automatic lighting control	●	●	●	●	●
IntelliLux adaptive LED® pixel headlights		●			●

PureConnect

Standard Pure Panel Features – The following features are standard across the entire all-new Astra range.

Pure Panel Digital Display

Pure Panel technology makes driving more intuitive, with a flowing design that presents the information you need. With a 10-inch infotainment colour touchscreen and 10-inch digital instrument cluster right in front of you, you can stay focused on the road ahead.

EV information display

- Powerflow display – Informs drivers on the current state of charge and what is being used as the power source, petrol or electric
- Charge display – displays an image of the charge port with the corresponding LED charge indication lights
- e-Save – enables the driver to determine how much battery energy needs to be conserved to ensure that the vehicle reaches its destination when in a zero emission zone
There are three options:
 - 6 mile range reserve
 - 12 mile range reserve
 - Maximum reserve
- Statistics – The Statistics display the average consumption data over a period of time using colour coded graphs
- **Green:** Energy recovered by braking phases and partial recharging by the petrol engine (kWh/mile)
- **Blue:** Energy consumed by the vehicle directly by the battery (kWh/mile)
- **Orange:** Fuel consumption (mpg)

Digital instrumentation

- Digital speedometer and rev counter
- Satellite Navigation display
- Digital fuel gauge with low fuel level warning light
- Digital water temperature gauge with warning light
- Shift-up/down indication light – Indicates when to change gear for optimum fuel economy

Driver information display

(centrally located in digital instrument cluster)

- Total mileage
- Service-due indicator
- Oil life
- Tyre pressure monitoring system

Multi-function trip computer

(displayed on digital instrument cluster)

- Trip mileage
- Vehicle range based on remaining fuel
- Average speed • Average fuel economy
- Instantaneous fuel economy • Driving time

Digital central facia display

- Audio information
- Digital clock with automatic RDS time adjustment
- Outside air temperature with ice warning function

Intelli-HUD (Head-Up Display) – Ultimate models only

The innovative Intelli-HUD head-up display projects the essential driving information onto the windscreen, in the driver's field of vision. Thanks to its resolution and its wide projection size, it gives a more realistic view of the information. The Intelli-HUD can display different pages linked to the instrument panel in order to share the displayed information on both screens. The pages can be selected via the left stalk. Pop-ups such as media, alerts, receiving calls and phone book can be displayed independently.



Pure Panel digital display.



Intelli-HUD (Head-Up Display).

Standard Features – Vauxhall Connect* is the new way to stay connected while on the road. Smart technology systems and related services keep our drivers safe and provide an exciting, efficient yet safe trip. Activating Vauxhall Connected Services is easy, just visit Vauxhall Connect Store or download MyVauxhall app.

Peace of mind

- Emergency call (SOS e-call)
- Breakdown call (b-call)
- Vehicle status and information**
- Maintenance alerts, fuel level, average fuel consumption and mileage



Vauxhall SOS

In the event of a breakdown or accident, you can count on Vauxhall Connect as your car has its own SIM card installed. If something happens that means there may have been an accident – say, the airbags are inflated or the pre-tensioners on the seatbelts are activated – an automatic message will go off to the emergency services, with details of your location. Vauxhall Connect SOS can be activated manually too – just press the button and you'll be put straight through to the emergency services on the system's integrated phone. So, if you have an accident, or see one, it only takes a few seconds to call for help.

Got a problem with your car but don't need the emergency services? Just press the Vauxhall Connect Assistance button and you'll be connected to our control centre over the system's integrated phone.

Convenience

- E-remote control (Plug-in HYBRID-e only)**
- Remote check of battery level, programming and charge management
- Pre-conditioning of vehicle temperature



E-remote

Check and manage your electric/hybrid vehicle range remotely and in real time using your smartphone. With MyVauxhall you can check the charge and range of your vehicle at any time, and if you're plugged into a charging point, you're even able to control charging when you're far away. To offer peace of mind, you can be alerted when the battery is full or the charging is interrupted.

The remote pre-conditioning feature allows you to warm or cool the vehicle to an optimal temperature before starting your journey. With your comfort in mind, this feature allows you to maximise range if your vehicle is on charge, by taking energy from the source, rather than the battery.

This service is supplied free of charge by Vauxhall for the life of the vehicle.

Drive Smart

- Live navigation† (subscription included for three years) with on-line traffic, fuel prices and parking information, Points Of Interest (POI) search and weather
- Trip and drive management**
- Timestamping of trips, trip details, last vehicle position, guide-to-car and more



Live Navigation Plus†

Vauxhall's fully integrated navigation system helps you stay informed, providing real-time information from the leading European GPS provider, TomTom®. It can be operated using natural voice recognition, meaning your eyes need never leave the road.

Vauxhall Live Navigation Plus is included free of charge for three years and can then be renewed at a cost.

- TomTom® services
- Real time traffic news
- Parking prices and availability
- Weather forecast on your journey
- Natural voice control
- Fuel prices at petrol stations
- Search for charging stations
- Quick search for addresses and points of interest
- Road safety alerts

Standard Infotainment Features – The following features are standard across the entire all-new Astra range.

Onboard features

- Satellite navigation system with natural voice recognition
- 2D/3D street level mapping
- European coverage
- Points-of-interest search
- Map updates via USB
- DAB Digital radio
- RDS with Traffic Programme
- AM/FM stereo radio with 36 station presets
- Six speakers
- Customizable screen adaption with enhanced profile management and driver recognition
- Heating, Ventilation and Air Conditioning (HVAC) user interface
- Over-the-air updates (e.g. for software)
- WiFi updates (e.g. content download)

Natural voice recognition

Works with 'wake-up' command 'Hey Vauxhall' to control the following functions:

- Satellite navigation commands
- Phone connectivity functions
- Choice of music playback
- Operation of electronic climate control

Media connections

- USB connection with iPod control
- Bluetooth® A2DP audio streaming (Advanced Audio Distribution Profile)

Mobile phone portal

- Bluetooth® connectivity
- Vehicle microphone
- Handsfree calls via steering wheel controls
- Phone book access – Contacts/last calls/missed calls etc are mirrored on the display and are easily navigated using the touchscreen (features dependent on mobile phone)
- SMS read out and reply

Smartphone interface

- Apple CarPlay
- Android Auto™
- Wireless smartphone projection that allows operations via voice command, touchscreen and buttons to control apps and music playback

Additional features

- Steering wheel mounted audio controls
- Shark fin aerial

Drive Smart

- Live navigation provided by TomTom® services (subscription free for three years and subject to fee thereafter)
- Real time traffic news
- Parking prices and availability
- Weather information
- Natural voice recognition
- Fuel prices
- Charging station search
- Quick search for addresses and points of interest
- Road safety alerts

For further details and terms and conditions see separate Vauxhall Connect page.

Please note that compatibility and certain functions may be different depending on the type of device and operating system you're using with the Multimedia systems. Apple CarPlay is a trademark of Apple Inc. Apple and iPhone are trademarks of Apple Inc., registered in the U.S. and other countries. Android is a trademark of Google Inc, also registered in the U.S. and other countries. Services may require a subscription/fee and are subject to mobile network coverage and availability. Live navigation and natural voice recognition services are included for 3 years and thereafter are subject to an additional subscription fee.



Digital infotainment display.



Satellite Navigation display.

Comfort and Convenience

Model Specific Features

Model Specific Features	Plug-in HYBRID-e models		Design	Plug-in HYBRID-e models	
	GS Line	Ultimate		GS Line	Ultimate
Interior Convenience					
Reach and rake adjustable steering	●	●	●	●	●
Steering wheel audio/phone/cruise controls	●	●	●	●	●
60/40 split-folding rear seat backs	hatchback only	●	hatchback only	hatchback only	●
Twin electrically adjustable/heated door mirrors	●	●	●	●	●
Electrically operated front and rear windows with safety autoreverse and one-touch up/down facility	●	●	●	●	●
Paddle shift	●	●		auto only	auto only
Front centre armrest with cup holder	●	●		●	●
Centre rear seat armrest and load-through facility	●	●		●	●
Frameless automatic anti-dazzle rear-view mirror	●	●		●	●
Flex load floor				●	●
Wireless charger for mobile devices		●			●
Keyless start			●		
Keyless entry and start	●	●		●	●
Heating and Ventilation					
Electronic climate control			●		
Dual-zone electronic climate control	●			●	
Dual-zone electronic climate control with Intelli-Air (air quality sensor)		●			●
Heated steering wheel and front seats	●	●		●	●
Heated windscreen		●			●

Model Specific Features/Option

	Plug-in HYBRID-e models		Design	GS Line	
	GS Line	Ultimate		GS Line	Ultimate
Interior Lighting					
Illuminated vanity mirrors and rear reading lights	●	●	●	●	●
Ambient lighting – customisable with eight different colours	●	●		●	●
Interior Style					
Black headliner	●	●		●	●
Alloy-effect sports pedals	●	●		●	●
Exterior Convenience					
Manually folding door mirrors			●		
Power folding door mirrors with puddle light	●	●		●	●
Panoramic sunroof		●			●
Tow bar	£605*	£605*	£605*	£605*	£605*

*Optional at extra cost including VAT.



VX_AST_33210

Ambient lighting.



VX_AST_33211

Alloy-effect sports pedals.



VX_AST_32999

Panoramic sunroof.

Versatility – Sports Tourer

Standard Features – The following features are available across the all-new Astra Sports Tourer range. Specific features by model are outlined in the separate tabular information.

Intelli-Space

- 40/20/40 split-folding rear seat backs
- Intelli-Space load floor adjustable in two heights for flat load area. Adds additional 40 litres of load volume in lower position
- Easy accessible storage boxes in the boot floor accommodate tyre inflation kit and first-aid kit

- Side storage with nets
- Luggage compartment retractable cover

Additional features (petrol/diesel)

- Spare-wheel storage area
- Rear seat backs with remote easy-fold facility

Additional feature (Plug-in HYBRID-e)

- Special under-carpet storage space for battery, charging cable, tyre inflation kit and first-aid kit

Model Specific Features

	Plug-in HYBRID-e model		
	GS Line	Design	GS Line
Interior Load Area			
Fixed floor with luggage restraining nets (pair)	●		
Flex load floor with luggage restraining nets (pair)		●	●
Rear seat load-through facility with armrest and cup holders	●		●



Intelli-Space 40/20/40 split rear seats.



Intelli-Space adjustable load floor.



Easy accessible storage boxes.

Design



Steering wheel:

- Three-spoke flat-bottom design
- Leather-covered
- Satin chrome-effect accents

Facia and door trim:

- Black facia with Modene trim inserts
- Instrument panel bar Alexit Grey
- Birdie Garey trim inserts on front doors
- Chrome-effect interior door handles

Seating:

- Driver's seat (six-way adjustable):
 - Height
 - Reach
 - Backrest
 - Head restraint
- Front passenger's seat (four-way adjustable):
 - Height
 - Reach
 - Backrest
 - Head restraint
- 60/40 split-folding rear seat backs
 - Hatchback
- 40/20/40 split-folding rear seat backs
 - Sports Tourer

Seat trim:

- Jet Black Modene seat trim inserts
- Jet Black Modene fabric side bolsters and surrounds

GS Line



Steering wheel:

- Three-spoke flat-bottom design
- Heated
- Perforated leather-covered with accent stitching
- Satin chrome-effect accents

Facia and door trim:

- Black facia with Isabella trim inserts
- Instrument panel bar Red Matt
- Mistral Black trim inserts on front doors
- Chrome-effect interior door handles

Seating:

- Ergonomic active sports-style driver's seat (AGR-approved*) (eight-way adjustable):
 - Height
 - Reach
 - Tilt
 - Backrest
 - Seat cushion extension
 - Head restraint
 - Lumbar adjustment (four-way electrical)
- Front passenger's seat (four-way adjustable):
 - Height - Reach
 - Backrest - Head restraint
- 60/40 split-folding rear seat backs
 - Hatchback
- 40/20/40 split-folding rear seat backs
 - Sports Tourer
- Heated front seats

Seat trim:

- Jet Black Greta fabric seat trim inserts
- Jet Black Greta side bolsters and surrounds

VX_AST_32913

*AGR (The Campaign for Healthier Backs) is an independent centre of excellence for ergonomics, based in Germany.

Ultimate



Steering wheel:

- Three-spoke flat-bottom design
- Heated
- Perforated leather-covered with accent stitching
- Satin chrome-effect accents

Facia and door trim:

- Black facia with High gloss black trim inserts
- Instrument panel bar Liquid Palladium
- Alcantara Tramontane inserts on front doors
- Chrome-effect interior door handles

Seating:

- Ergonomic active sports-style front seats (AGR-approved*)
- Driver's seat (eighteen-way adjustable)
 - Height (electrical) - Reach (electrical)
 - Tilt (electrical) - Backrest (electrical)
 - Seat cushion extension
 - Lumbar adjustment (four-way electrical)
 - Head restraint
 - Pneumatically adjustable backrest side bolsters

- Front passenger's seat (Eight-way adjustable)
 - Height - Reach - Backrest
 - Seat cushion extension
 - Head restraint
 - Lumbar adjustment (four-way electrical)
- Heated front seats
- 60/40 split-folding rear seat backs

Seat trim:

- Alcantara seat trim inserts
- Alcantara side bolsters and surrounds

VX_AST_PHEV_32912

*AGR (The Campaign for Healthier Backs) is an independent centre of excellence for ergonomics, based in Germany.

Ultimate – Leather (extra-cost option)



Steering wheel:

- Three-spoke flat-bottom design
- Heated
- Perforated leather-covered with accent stitching
- Satin chrome-effect accents

Facia and door trim:

- Black facia with High gloss black trim inserts
- Instrument panel bar Liquid Palladium
- Black premium leather-effect inserts on front doors
- Chrome-effect interior door handles

Seating:

- Ergonomic active sports-style front seats (AGR-approved*)
- Driver's seat (eighteen-way adjustable)
 - Height (electrical) – Reach (electrical)
 - Tilt (electrical) – Backrest (electrical)
 - Seat cushion extension
 - Lumbar adjustment (four-way electrical)
 - Head restraint
 - Active ventilation
 - Pneumatically adjustable backrest side bolsters
 - Massage and memory seat adjuster functions

- Front passenger's seat (Eight-way adjustable)
 - Height – Reach – Backrest
 - Seat cushion extension
 - Head restraint
 - Lumbar adjustment (four-way electrical)
 - Active ventilation
- Heated front and outer rear seats
- 60/40 split-folding rear seat backs

Seat trim:

- Leather seat trim inserts
- Leather-effect side bolsters and surrounds

Optional seating priced at £2,100 including VAT

VX_AST_PHEV_32911

*AGR (The Campaign for Healthier Backs) is an independent centre of excellence for ergonomics, based in Germany.

Safety and Security

Model Specific Features

Model Specific Features	Plug-in HYBRID-e models		Design	GS Line	Ultimate
	GS Line	Ultimate			
Airbags					
Driver's and front passenger's airbag	●	●	●	●	●
Front seat side-impact airbags	●	●	●	●	●
Full-size curtain airbags	●	●	●	●	●
Braking					
In crash braking – the system automatically brakes the vehicle to help it come to a standstill after a severe collision	●	●	●	●	●
Hill start assist – holds the vehicle steady for two seconds on slopes with a gradient of over 3% after the brake pedal is released.	●	●	●	●	●
Child Safety					
Deactivation switch for front passenger's front and side-impact bags	●	●	●	●	●
ISOFIX child seat mountings – located on outer rear seats incorporating top tether mounting points. (Does not include child seat)	●	●	●	●	●
Security					
Remote control ultrasonic security alarm system	●	●	●	●	●
Locking wheel bolts for alloy wheels	●	●	●	●	●



Hill start assist.



In-crash braking.



ISOFIX child seat mountings.

Styling – Hatchback

Model Specific Features/Option

	Plug-in HYBRID-e models		Design		
	GS Line	Ultimate		GS Line	Ultimate
Exterior Styling					
Body-colour door handles	●	●	●	●	●
Black lower window moulding	●	●	●	●	●
Black-painted door mirrors	●	●	●	●	●
Body-colour bumpers with grained black lower front grille and rear valance panel			●		
Body-colour sports-style bumpers with high gloss black lower front grille, decor blade and rear valance panel	●	●		●	●
Chrome-effect Griffin logo and vizer frame			●		
Black Griffin logo and vizer frame	●	●		●	●
Dark-tinted rear windows	●	●		●	●
Body-colour roof and rear spoiler	No-cost	No-cost	●	No-cost	No-cost
Carbon black roof and rear spoiler*	●	●		●	●

*Standard with Carbon Black body colour.

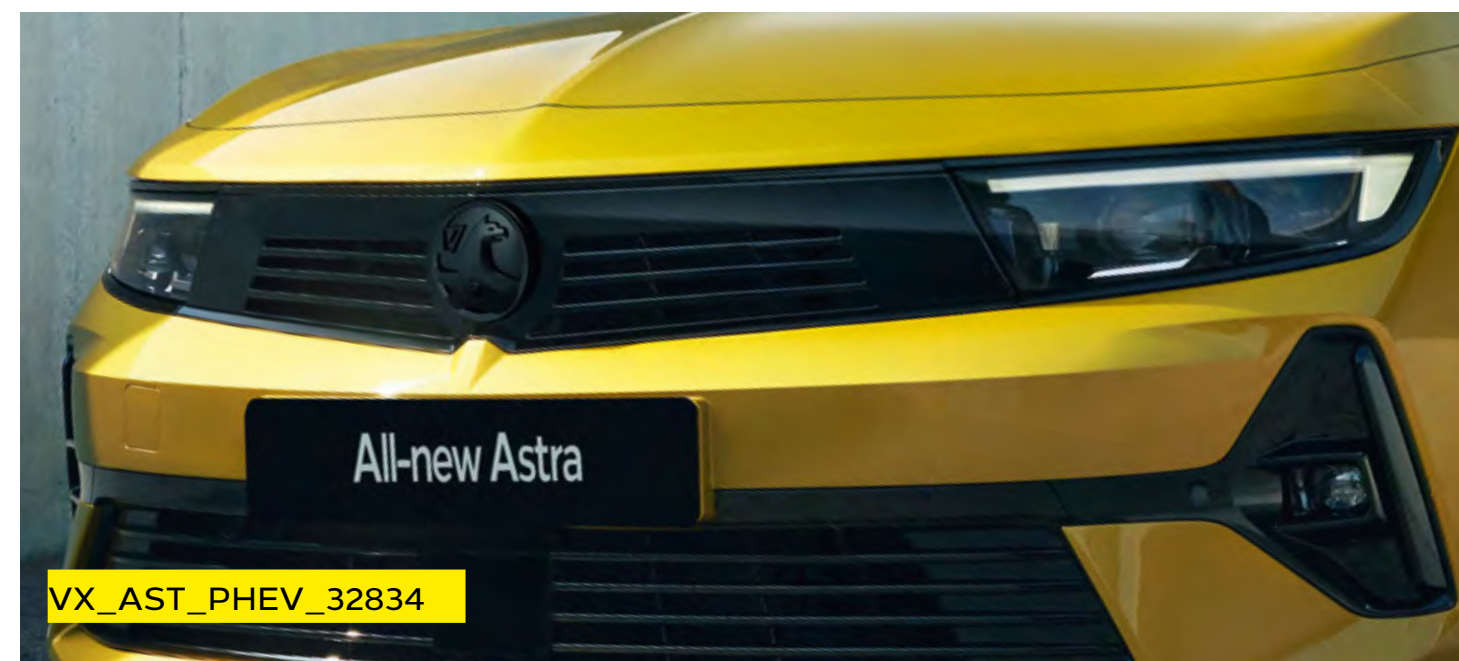

Black Griffin logo and vizer frame.



Black roof and dark-tinted rear windows.



Rear styling.

Styling – Sports Tourer

Model Specific Features/Option

	Plug-in HYBRID-e model		
	GS Line	Design	GS Line
Exterior Styling			
Body-colour door handles	●	●	●
Black lower window moulding	●	●	●
Black-painted door mirrors	●	●	●
Body-colour bumpers with grained black lower front grille and rear valance panel		●	
Body-colour sports-style bumpers with high gloss black lower front grille, decor blade and rear valance panel	●		●
Chrome-effect Griffin logo and vizer frame		●	
Black Griffin logo and vizer frame	●		●
Dark-tinted rear windows	●		●
Body-colour roof and rear spoiler	No-cost	●	No-cost
Carbon black roof and rear spoiler*	●		●
Silver-effect roof rails	●		●

*Standard with Carbon Black body colour.

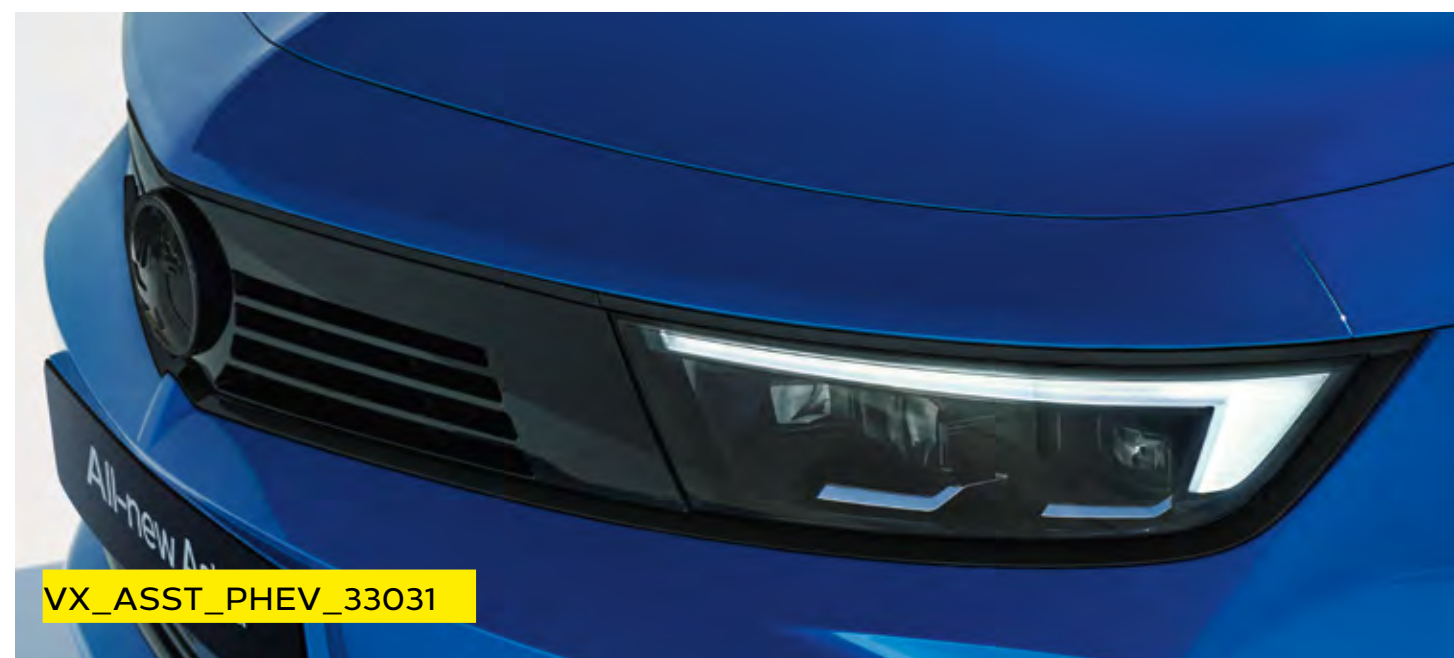

VX_ASST_PHEV_33031

Black Griffin logo and vizer frame.



VX_ASST_33236

Black roof and dark-tinted rear windows.



VX_ASST_33251

Rear styling.

Exterior Colours

Arctic White (G2O)*
Brilliant paint



VX_AST_PHEV_32844

Carbon Black (G70)**
Two-coat metallic paint **£600**



VX_AST_PHEV_32850

Vulcan Grey (G40)**
Two-coat metallic paint **£600**



VX_AST_PHEV_32848

Crystal Silver (GAU)**
Two-coat metallic paint **£600**



VX_AST_PHEV_32849

Crimson Red (G1R)**
Two-coat premium metallic paint **£700**



VX_AST_PHEV_32845

Electric Yellow (GBO)†
Two-coat premium metallic paint **£700**



VX_AST_PHEV_32847

Cobalt Blue (GYX)**
Tri-coat premium metallic paint **£700**







VX_AST_PHEV_32846

The colours reproduced may vary slightly from the actual paint colour. As a result they should be used as a guide only. Your Vauxhall Retailer has a comprehensive display of our paint samples.

Please note, vehicles illustrated are not model specific and are for illustrative purposes only.

*Standard exterior paint. **Optional at extra cost including VAT. †Optional at extra cost including VAT. Not available on Sports Tourer models.

Wheels and Tyres

		Plug-in HYBRID-e models				
		GS Line	Ultimate	Design	GS Line	Ultimate
 VX_AST_32864_SKH	16-inch silver alloy wheels • 205/55 R 16 tyres • Emergency tyre inflation kit			●		
 VX_AST_32866_QOJ	17-inch black alloy wheels • 225/45 R 17 tyres • Emergency tyre inflation kit	●			●	
 VX_AST_32868_PU1	18-inch bi-colour diamond-cut alloy wheels with grey inserts • 225/40 R 18 tyres • Emergency tyre inflation kit	£300*	●		£300*	●
 VX_AST_32867_PU2	18-inch bi-colour diamond-cut alloy wheels with red inserts • 225/40 R 18 tyres • Emergency tyre inflation kit	£300*			£300*	
Provision for spare wheel fitment (spare wheel is Retailer-fit)				£20*	£20*	

*Optional at extra cost including VAT.

Plug-in HYBRID-e Specifications*

Electrified Transmission

The 8-speed electrified transmission system is standard and offers both smooth transition between gears. The 8-speed electrified gearbox includes the following content:

- Multi-disc wet clutch replaces removed torque converter
- Permanent electric motor that transforms electric energy into mechanical drive energy
- Electric motor installed into the gearbox and petrol engine
- Comes with intuitive and stylish automatic gearbox with electric shifter with shift paddles

The current driving position is indicated to the driver with a LED between:

- **R:** used for reverse driving
- **N:** used for neutral, allowing the vehicle to be moved with ignition off
- **D:** used for automatic drive, the gearbox change gears without any action from the driver
- **B button:** to switch to regenerative braking

Drive Mode Selector

The Drive Mode selector is positioned next to the automatic gearbox with electric shifter and enables drivers to select one of the following:

- Hybrid is the default mode and offers the best of both worlds between controlled fuel consumption and on-road performance
- Sport Mode, draws on the combined power of the engine and motor for a more dynamic drive
- Electric activates the electric engine only, for zero CO₂ emissions and complete silence

Weights

- Kerbweight: 1678kg Hatchback/1717kg Sports Tourer
- Gross vehicle weight: 2150kg Hatchback/2170kg Sports Tourer
- Maximum towing weight:
Braked trailer 1450kg Hatchback/
1400kg Sports Tourer (without brakes 750kg)

Charging

- All-new Astra Plug-in HYBRID-e range comes with a Mode 2 cable and a 3.7kW on-board charger as standard. Includes cable bag at no extra cost
- A 7kW on-board charger can be purchased as an option for £500 inc VAT

This option halves the vehicle charging time when charging with a 7kW wallbox.

Please note: A Mode 2 cable (standard UK socket**) would charge the vehicle in less than 8 hours.

All-new Astra Plug-in HYBRID-e range charging time examples are listed showing times dependant on the various powers of charge point which the vehicle is plugged into.

Charging		
Supply	Socket	Charge Time (0-100%)
AC current - Domestic 3 pin socket (2.3kW)	Type 2	5h 30m
AC current - Home wallbox or public charger (3.6kW)	Type 2	3h 30m
AC current - Home wallbox or public charger (7kW) [†]	Type 2	1h 55m



Preliminary data determined according to WLTP test procedure methodology. EU type approval and Certificate of Conformity are not yet available. Preliminary values may differ from official final type approval data. Charging rate depends on power source and charging cable used.

*Provisional data. **Only use a domestic electrical socket that has been checked by a qualified electrician and is protected by a circuit breaker adapted to the amperage of the electrical circuit. [†]Requires optional 7kW on board charger.

Petrol Engine*

Petrol Engine	1.6 (180PS) Direct Injection Turbo/Electric
Maximum power	150PS (110kW) @ 6000rpm
Combined power	180PS (133kW) @ 6000rpm
Maximum torque	250Nm (184lb.ft.) @ 1750rpm
Combined torque	360Nm (265lb.ft.) @ 6000rpm
Combined CO ₂ emissions (WLTP)#	24–26g/km
Combined fuel economy (WLTP)#	256 mpg (1.1 l/100km)
Combined maximum speed	140mph
0–60mph	7.7 secs
Configuration	4 cylinders, 4 valves per cylinder, double overhead camshafts
Fuel/induction system	Turbocharger. Variable Valve Timing. Common rail direct injection
Emission compliance	Euro 6d
Service interval	20,000 miles or 1 year (whichever occurs sooner)

Convenience

- E-remote control
- Remote check of battery level, programming and charge management
- Pre-conditioning of vehicle temperature

For further details and terms and conditions see separate Vauxhall Connect page.

Please note, EV range assumes that vehicle has been pre-conditioned prior to journey. This function can be accessed via MyVauxhall App or Infotainment system.

These figures were obtained using a combination of battery power and fuel. The all-new Astra Plug-in HYBRID-e requires mains electricity for charging.

#WLTP Figures shown are for comparison purposes and should only be compared to the fuel consumption, CO₂ values and electric range of other cars tested to the same technical standard. The fuel consumption and electric range achieved, and CO₂ produced, in real world conditions will depend upon a number of factors including, but not limited to: the accessories fitted (pre and post registration); charging frequency; battery condition; variations in weather; driving styles and vehicle load. For more information contact your local Vauxhall Retailer.

*Provisional data.

Electric Motor*

Electric Motor	
Maximum power	110hp (81kW) @ 2500rpm
Battery	
Battery capacity	12.4kWh
AC on-board charger speed (standard)	3.7kW
Equivalent All Electric Range – EAER (WLTP high)#	up to 43 miles (hatchback)/42 miles (sports tourer)
Energy consumption (WLTP combined)	16kWh/100km
Battery warranty	8 years/100,000 miles/70% capacity

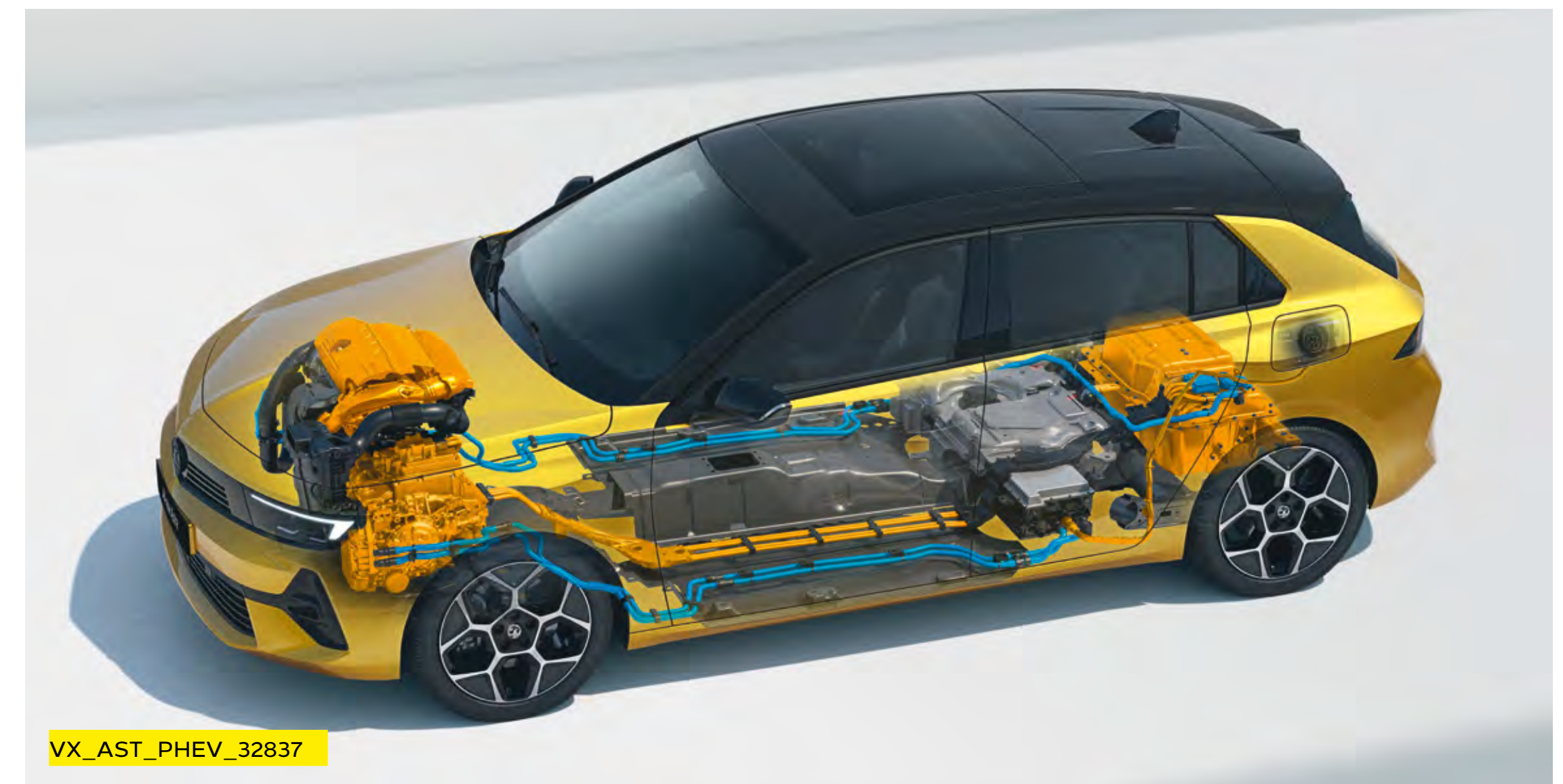

VX_AST_PHEV_32837

Petrol Engines

	1.2 (110PS) Turbo	1.2 (130PS) Turbo
Capacity	1199cc	1199cc
Maximum power	110PS (81kW) @ 5500rpm	130PS (96kW) @ 5500rpm
Maximum torque	205Nm (151lb.ft.) @ 1750rpm	230Nm (169lb.ft.) @ 1750rpm
Configuration	3 cylinders, 4 valves per cylinder, double overhead camshafts	3 cylinders, 4 valves per cylinder, double overhead camshafts
Fuel/induction system	Turbocharger. Variable Valve Timing (VVT). Spark ignited direct injection (SIDI)	Turbocharger. Variable Valve Timing (VVT). Spark ignited direct injection (SIDI)
Emission compliance	Euro 6d (6.3)	Euro 6d (6.3)
Service interval	12,500 miles or 1 year (whichever occurs sooner)	12,500 miles or 1 year (whichever occurs sooner)

Diesel Engine

	1.5 (130PS) Turbo D
Capacity	1498cc
Maximum power	130PS (96kW) @ 3750rpm
Maximum torque	300Nm (221lb.ft.) @ 1750rpm
Configuration	4 cylinders, 4 valves per cylinder, double overhead camshafts
Fuel/induction system	Turbocharger. Common rail fuel injection
Emission compliance	Euro 6d (6.3)
Service interval	20,000 miles or 1 year (whichever occurs sooner)

Specifications

Transmission

Six-speed manual gearbox

Petrol engines: 1.2 (110/130PS) Turbo models

Diesel engine: 1.5 (130PS) Turbo D model

8-speed automatic transmission

Available on the 1.2 (130PS) Turbo/1.5 (130PS) Turbo D, the 8-speed automatic transmission enables increased drive comfort and improved fuel economy. The automatic gear lever has been replaced by an ergonomic e-toggle in harmony with the interior design. The new e-toggle is standard for combustion engine and Plug-in hybrid.

The current driving position is indicated to the driver with a LED between:

- **R:** used for reverse driving
- **N:** used for neutral, allowing the vehicle to be moved with ignition off
- **D:** used for automatic drive, the gearbox change gears without any action from the driver
- **M button:** Manual shifting mode for combustion engines. The driver changes gears with the shift paddles on steering wheel

The driver can also select between three different driving modes, Sport, Normal and Eco, which offer several enhancements to the driving experience.



VX_AST_32924

Braking and stability

- Electronic Stability Programme (ESP) – ESP monitors many different inputs to determine when the car starts to lose traction, it can then immediately respond by varying the brake pressure between up to three wheels and adjust the engine output to help correct the loss of traction and improve stability
- Cornering brake control
- Straight line stability control
- Rollover mitigation
- Drag torque control – Maintain stability on slippery roads when lifting off the accelerator or changing gear
- Hill start assist
- Anti-lock Braking System (ABS)
- Emergency brake assist
- Fading brake support
- Electronic brakeforce distribution
- Adaptive brake lights

Steering

- Power-assisted steering
- Turning circle (wall-to-wall):
 - 10.51m (34.5ft.) Hatchback
 - 10.71m (35.1ft.) Sports Tourer

Fuel Tank Capacity

52 litres (11.4 gallons) Petrol/Diesel

42 litres (9.2 gallons) Plug-in HYBRID-e

AdBlue® tank capacity

13 litres (2.8 gallons)

Start/Stop technology

All-new Astra's feature Start/Stop technology offering real benefits by improving fuel economy and reducing CO₂ emissions, particularly in town. It does this by automatically stopping the engine when you come to a standstill, and then restarting as you prepare to move off.

Before automatically stopping the engine a number of system checks are carried out to ensure that it is both safe and practical to do so. To ensure safety, the driver must depress the clutch pedal, shift in to neutral, and then release the clutch pedal.

System checks carried out before Auto Stop activates include:

- Start/Stop system is not manually deactivated via the facia button
- Sufficient brake vacuum is available to prevent the car rolling down an incline
- Battery is in good condition and charged
- Outside air temperature and engine temperature are above specified minima
- Electronic climate control (where fitted) is not in maximum heating or maximum cooling mode
- Self-cleaning function of the diesel particulate filter is not active

If all of these conditions are satisfied then the vehicle will Auto Stop.

When you are ready to pull away from standstill, Auto Restart is activated by depressing the clutch pedal.

Whilst at a standstill the vehicle is continually monitored. If necessary, the engine will automatically be restarted. Conditions that would initiate an Auto Restart include:

- Low battery level
- Brake vacuum below specified minimum
- Start/Stop system is manually deactivated
- Stationary for 5.5 minutes

Performance, Fuel Economy and Emissions**

	Performance (manufacturer's figures)		Fuel economy mpg (litres/100km)#		CO ₂ emissions g/km#		Vehicle Excise Duty*		BiK rates from - 2022/23 tax year
	Maximum speed (mph)	Acceleration 0-60mph (sec)	Combined Low	Combined High	Combined Low	Combined High	First year rate	Standard rate	
Hatchback									
1.2 (110PS) Turbo	124	10.5	51.4 (5.5)	51.4 (5.5)	123	124	£190	£165	29%
1.2 (130PS) Turbo	130	9.7	50.5 (5.5)	51.4 (5.6)	123	127	£190	£165	29%
1.2 (130PS) Turbo auto	130	9.7	49.5 (5.6)	50.5 (5.7)	126	129	£190	£165	30%
1.5 (130PS) Turbo D	130	10.6	62.8 (4.3)	65.7 (4.5)	114	117	£190	£165	27%
1.5 (130PS) Turbo D auto	130	10.6	61.4 (4.5)	62.8 (4.6)	118	121	£190	£165	28%
Sports Tourer									
1.2 (110PS) Turbo	124	10.8	50.5 (5.6)	50.5 (5.6)	126	127	£190	£165	30%
1.2 (130PS) Turbo	130	10.0	49.5 (5.6)	50.5 (5.7)	126	129	£190	£165	30%
1.2 (130PS) Turbo auto	130	9.9	48.7 (5.7)	49.5 (5.8)	128	132	£190	£165	30%
1.5 (130PS) Turbo D	130	10.8	62.8 (4.4)	64.2 (4.5)	116	119	£190	£165	28%
1.5 (130PS) Turbo D auto	129	11.0	60.1 (4.5)	62.8 (4.7)	119	122	£190	£165	28%

#Figures shown are for comparison purposes and should only be compared to the fuel consumption and CO₂ values of other cars tested to the same technical standard. The fuel consumption achieved, and CO₂ produced, in real world conditions will depend upon a number of factors including, but not limited to: the accessories fitted (pre and post registration); variations in weather; driving styles and vehicle load. The WLTP (Worldwide Harmonised Light Vehicles Test Procedure) is used to measure fuel consumption and CO₂ figures. The CO₂ figures display a range to reflect the highest value for the highest emitting version with all available options added, through to a minimum value to represent the lowest emitting version in standard specification.

*Correct at time of publication. **Provisional data.

Weights and Towing Data ^{kg} **

	Gross vehicle weight		Maximum towing weights Trailer with brakes (without brakes)	
	Hatchback	Sports Tourer	Hatchback	Sports Tourer
1.2 (110PS) Turbo	1820	1870	1250 (660)	1200 (680)
1.2 (130PS) Turbo	1840	1880	1250 (660)	1200 (690)
1.2 (130PS) Turbo auto	1880	1900	Factory-fit 1400 / Retailer-fit 1200 (680)	Factory-fit 1400 / Retailer-fit 1200 (710)
1.5 (130PS) Turbo D	1920	1960	1550 (710)	1500 (730)
1.5 (130PS) Turbo D auto	1940	1980	1550 (710)	1500 (740)

Please note: Gross vehicle weight is the total permissible weight of the vehicle including passengers and their luggage. The maximum roof rack loading should not exceed 75kg. The maximum towing weights are based on the ability of the car, with two occupants of 75kg each, to restart on a 12% gradient, which is approximately 1 in 8.3, at sea level. The permitted trailer load applies up to the specified incline and up to an altitude of 1000 metres above sea level. The permissible gross train weight decreases by 10% for every 1000 metres of additional altitude. At altitudes above 1500 metres, the engine output may drop with a corresponding reduction in towing capability. Any extra weight, such as luggage or additional passengers, should be deducted from the maximum towing weight. With a trailer fully loaded, maximum noseweight should not exceed 75kg. Always fit Vauxhall towing attachments and accessories available from your Vauxhall Retailer. They are designed specifically for Vauxhall models and carry a 12-month guarantee.

**Provisional data.

Dimensions and Capacities All measurements in mm (inches) unless stated otherwise.

Loadspace Dimensions	Hatchback	Sports Tourer
Load floor length (rear seats folded)	1589 (62.5)	1850 (72.8)
Load floor length (behind rear seats)	795 (31.3) 770 (30.3)**	1026 (40.3) 1018 (40.0)**
Load area width	1020 (40.2)	1032 (40.6)
Load area height	599 (23.5) 601 (23.6)**	599 (23.5) 601 (23.6)**
Tailgate aperture width (maximum)	1019 (40.1)	tba
Tailgate aperture height	526 (20.7)	482 (18.9)

Luggage Capacities* Litres (cu.ft.)	Hatchback	Sports Tourer
Rear seat up (under luggage compartment cover)	422 (14.9) 352 (12.4)**	597 (21.0) 516 (18.2)**
Rear seat down (measured to roof)	1339 (47.2) 1268 (44.7)**	1634 (57.7) 1553 (54.8)**

*Measured using the ECIE method. When a spare wheel is specified loadspace capacity is reduced due to a raised luggage compartment floor. **Plug-in HYBRID-e.

Hatchback



Sports Tourer



Company Car Driver and Fleet Information

Benefit in kind company car taxation*

The car benefit charge will be the car's list price (including VAT, options and accessories fitted, delivery to Retailer and number plates, but excluding Vehicle Excise Duty and new vehicle first registration fee) multiplied by the percentage charge for the CO₂ emissions band in which the car falls (see table opposite). Multiply this figure by your personal income tax rate (20%** for Basic Rate, 40%** for Higher Rate) to calculate your annual benefit in kind tax liability.

Generic example:

HYBRID-e vehicle: 24g/km CO₂, up to 43 miles (electric-only range)

On-the-road RRP	£32,200.00
Deduct: Vehicle Excise Duty	-£10.00
New vehicle first registration fee	-£55.00
Effective list price	£32,135.00
Add: Optional two-coat metallic paint	£600.00
List price for tax purposes (P11D value)	£32,735.00
Car benefit charge 2022-23 tax year (28%)	£2,619.00
Benefit in kind tax liability	
Basic Rate (20%) tax payer	£523.80
Higher Rate (40%) tax payer	£1,047.60

*Please note this Price Guide provides taxation information as a guide only. Vauxhall does not provide taxation guidance. Drivers should always take professional advice on their own tax position.
**Excludes residents of Scotland.

BiK for Scottish Residents

Effective 6 April 2018 the Scottish Government have introduced their own BiK taxation structure. This only applies to Company Car Drivers that are Scottish taxpayers. HMRC will determine whether or not an individual is a Scottish taxpayer based on where their main place of residence is.

The BiK rates for Scotland are:

- Over £12,570 - £14,732 Starter Rate 19%
- Over £14,732 - £25,688 Basic Rate 20%
- Over £25,688 - £43,662 Intermediate Rate 21%
- Over £43,662 - £150,000 Higher Rate 41%
- Above £150,000 Top Rate 46%

CO ₂ emissions (g/km)	Percentage of cars price to be taxed 2022-23 tax year
Up to 50	14%
51 - 54	15%
55 - 59	16%
60 - 64	17%
65 - 69	18%
70 - 74	19%
75 - 79	20%
80 - 84	21%
85 - 89	22%
90 - 94	23%
95 - 99	24%
100 - 104	25%
105 - 109	26%
110 - 114	27%
115 - 119	28%
120 - 124	29%
125 - 129	30%
130 - 134	31%
135 - 139	32%
140 - 144	33%
145 - 149	34%
150 - 154	35%
155 - 159	36%
160 - 164	37%
165 - 169	37%
170+	37%

CO ₂ emissions (g/km)	Electric range (miles)	Percentage of cars price to be taxed 2022-23 tax year
0	-	2%
1 - 50	130+	2%
1 - 50	70 - 129	5%
1 - 50	40 - 69	8%
1 - 50	30 - 39	12%
1 - 50	<30	14%

To calculate your own personal liability, search: **Vauxhall BiK**, or click the link below:

[Vauxhall BiK Tool](#)

Fleet Toolbox

Discover the facts in our online Toolbox for both Company Car Drivers and Fleet Decision Makers. The Fleet Toolbox has a host of useful calculators, comparators, interactive listings and information.

Search Vauxhall Fleet Tools or click the link below:

[Vauxhall Fleet Tool Box](#)

Contact Vauxhall Fleet

Please contact one of our dedicated sales teams who will be happy to help with your particular enquiry.

Company Car Drivers

Call: 0345 111 2020

Email: company-car@vauxhallinfo.co.uk

Telephone lines are open

- Monday to Friday 8:00am-9:00pm

- Saturday and Sunday 9:00am-6:00pm

Fleet Decision Makers

Depending on the size of your fleet of vehicles, we have a dedicated team to handle your enquiries. The lines are open Monday to Friday excluding Bank Holidays.

1-24 vehicles

Call: 0845 076 2254 (8:30am-5:00pm)

25+ vehicles

Call: 0330 587 8222 (8:30am-5:00pm)

Email: vauxhallfleet@vauxhall.co.uk

Special Vehicles (Police, Fire and Ambulance)

Call: 01582 409999 (8:30am-5:00pm)

Email: vauxhallspecialvehicles@vauxhall.co.uk

Further Information

On-the-road prices

To eliminate uncertainty about hidden costs when buying a new car, Vauxhall publishes on-the-road recommended retail prices (RRP) and these are shown in the pricing tables within this price guide. These prices include VAT, number plates and delivery to Retailer of £700.00 (including £116.67 VAT), 12 months' Government Vehicle Excise Duty (see opposite for details) and the DVLA new vehicle first registration fee of £55.00.*

Please note: The on-the-road recommended retail price (RRP) does not include fuel supplied by the Retailer, motor insurance or any other goods or services supplied by agreement between the Retailer and the customer.

Price protection

Order a new Vauxhall for build in the current model year (as confirmed by your Retailer) for delivery no more than three months in advance and the price you are quoted is the price you pay. This is irrespective of any subsequent price rises between placing your order and delivery of your new car, but you must take delivery as soon as the car is available.

Please note: Price protection does not apply to hybrid models. Vauxhall Motors Limited is not liable for price adjustments caused by Government changes in the rate of VAT (currently 20%), Vehicle Excise Duty, DVLA new vehicle first registration fee or by any other applicable legislation or regulations.

In the event of an accident

Vauxhall Accident Management helps keep you mobile following an accident. Benefits include vehicle recovery, Vauxhall-approved repairs and contacting your insurer. For more details, visit vauxhall.co.uk/AccidentManagement

Free2Move Lease

Whether you're a big company or a small business looking for vehicle financing, Free2Move Lease, our business finance specialists, can deliver exactly what you need.

Free2Move Lease is one of the UK's largest leasing companies and is also a member of the British Vehicle Rental and Leasing Association (BVRLA).

With over 60,000 vehicles in the Free2Move Lease portfolio, Free2Move Lease is able to offer competitive vehicle solutions. In addition, Free2Move Lease also offer innovative connected management of servicing and maintenance.

For further information, please contact your local Vauxhall Retailer or visit vauxhall.co.uk/offers-finance/business-leasing.html

Vehicle Excise Duty

The amount of Vehicle Excise Duty (road fund licence) payable on new cars varies depending on the level of carbon dioxide (CO₂) emissions produced by the vehicle. CO₂ emissions are measured in grams per kilometre (g/km) travelled and divided into 13 charging bands shown in the table opposite.

A 'first year rate' of Vehicle Excise Duty is payable on all new cars and in subsequent years the amount payable reverts to the 'standard rate'. From 1 April 2017 the breakpoints for each of these bands have been revised. Also, for vehicles with a list price over £40,000, including factory-fitted options, an additional £335 is payable for the first five years of standard rate payments.

Vehicle Excise Duty*

Band	CO ₂ emissions in grams per kilometre	First year rate Petrol/Diesel	Standard rate Petrol/Diesel	Standard rate Hybrid
A	0	£0	£0	£0
B	1 – 50	£10	£165	£0
C	51 – 75	£25	£165	£15
D	76 – 90	£120	£165	£110
E	91 – 100	£150	£165	£140
F	101 – 110	£170	£165	£160
G	111 – 130	£190	£165	£180
H	131 – 150	£230	£165	£220
I	151 – 170	£585	£165	£575
J	171 – 190	£945	£165	£935
K	191 – 225	£1,420	£165	£1,410
L	226 – 255	£2,015	£165	£2,005
M	Over 255	£2,365	£165	£2,355

*Correct at time of issue.

Further Information

Customer Care Commitment

For added peace of mind, Vauxhall has an innovative Customer Care Commitment that offers the following:

- Three-year vehicle warranty consisting of a one-year/unlimited mileage manufacturer's warranty and a second and third year manufacturer's warranty with a 60,000 miles limitation
- Vauxhall Assistance for 12 months from first registration
- Six years' body panel anti-perforation warranty

Please note: Warranty is only available on vehicles sourced from Vauxhall Motors Limited. Terms and conditions apply – please see your Vauxhall Retailer for details.

Vauxhall Assistance

Vauxhall Assistance is provided automatically with every new Vauxhall for 12 months from first registration and covers everything from accident assistance, roadside recovery and 'at home' service to flat tyres. For even more peace of mind, for Plug-in HYBRID-e models the cover is extended* to 8 years or 100,000 miles, whichever comes first. Even more reason for you to stay calm and let us take care of everything should the need arise. With Vauxhall Assistance help is literally just a free** phone call away, 24 hours a day, 365 days a year!

Protecting the environment

Vauxhall's commitment to the environment is demonstrated by our products' many environmental awards. For even more information on Vauxhall's efforts to achieve an environmentally sustainable future, and how to dispose of your end-of-life vehicle, see vauxhall.co.uk/recycling

Vauxhall Care

This all-inclusive service package is available on Vauxhalls under 10 months old (from date of first registration).

This package offers complete peace of mind for the first 3 years of your Vauxhall's life with fixed monthly payments for the plan duration.

- **3 years' Vauxhall servicing** – covers first, second and third annual services. Including a brake-fluid change in the second service
- **2 years' Vauxhall Roadside Assistance** – first year from us
- **First years' MOT[†]** – free of charge by your local Vauxhall Retailer

For full terms and conditions and to sign up, visit: vauxhall.co.uk/vauxhallcare

Vauxhall Service Club

Vauxhall Service Club is available for all Vauxhall owners, and it's free to join. Members benefit from the following:

- 15% off Vauxhall Approved Accessories
- Vauxhall's aged 2-3 Years = 15% off parts and labour
- Vauxhall's aged over 3 Years = 25% off parts and labour
- Half price MOT's (NI excluded)
- Free pre-MOT test inspection (NI only)
- Fixed price AdBlue[®] Refills
 - Car = £14.99
 - Van = £24.99
- Access to the Vauxhall Accident Management Programme
- Online service booking available 24/7 with servicing appointments available within 3 days – [Book Online](#)
- Collection and delivery/onward mobility options
- Complimentary 'Wash and Vac' with all routine services^{††}
- Vauxhall trained technicians
- Genuine Vauxhall parts
- Minimum 12 months warranty on parts and labour
- Regular newsletters with exclusive offers, discounts and competitions

Terms and conditions apply. To join visit: vauxhall.co.uk/serviceclub

Vauxhall Insurance with added reassurance

Comprehensive cover – Summary of benefits

- Competitive premiums
- Repairs by a Vauxhall-trained technician
- Genuine Vauxhall parts, guaranteed for five years when we repair your car within our Approved Repairer Network
- Free courtesy car as standard when using an Approved Repairer[‡]
- 24 hour claims helpline
- Personal Accident benefit
- Cover for audio equipment
- Windscreen cover

Call for a quote on 0330 678 1130^{‡‡}

For more product information

For further information on the Vauxhall range or location of your nearest Vauxhall Retailer please call 0345 600 1500. Alternatively, details can be found on our website at vauxhall.co.uk

For more information call **0345 600 1500**

For Fleet enquiries call **0330 587 8222**

Discover the full Vauxhall range at **[vauxhall.co.uk](https://www.vauxhall.co.uk)**

Join us online

The invoice price, including delivery to Retailer, factory-fitted options, accessories fitted by the Retailer and number plates, is subject to VAT. Some feature descriptions in this guide may refer to, and some illustrations may show, optional equipment not included in the standard delivery. The information contained in this guide was accurate at the time of publication. We reserve the right to make changes in design and equipment. Please note that Vauxhall Retailers are not the agents of Vauxhall Motors Limited and are not authorised to bind Vauxhall Motors Limited by any specific or implied undertaking or representation. It is advisable to ensure that your motor insurance policy provides adequate cover for additional fitted options and accessories. The colours in this guide are only approximate actual colours. Illustrated optional equipment is available at extra charge. Availability, technical features and equipment provided on our vehicles can vary by model. For precise information on the equipment provided on our vehicles, please contact your local Vauxhall Retailer.

VAUXHALL

Price and Specification Guide
6 April 2022 | Model Year 2022D



Mokka

Contents

To find the information you want use the links below to navigate around the guide:

[Pure Technology](#)

[Choose Your Trim Level](#)

[Range Highlights](#)

[Models](#)

[Prices](#)

[PureSense](#)

[PureConnect](#)

[Comfort and Convenience](#)

[Safety and Security](#)

[Lighting](#)

[Styling](#)

[Exterior Colours](#)

[Wheels and Tyres](#)

[Specifications](#)

[Dimensions and Capacities](#)

[Accessories](#)

[Company Car Information](#)

[Further Information](#)

Pure Technology

The Mokka is an all-round class-leading car, with an advanced plug-in hybrid option and intuitive technology. IntelliLux adaptive LED[®] Matrix headlights with 84 elements per headlamp, state-of-the-art driver assistance systems and the new fully digital 'Pure Panel' dashboard.

Vauxhall Pure Technology

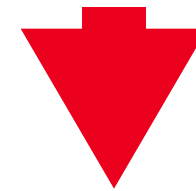

Vauxhall PureEnergy

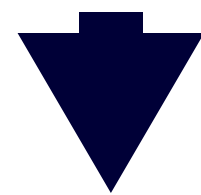

All-electric Mokka-e.

- 100% electric
- Total cost of ownership equal to Petrol and Diesel models
 - Up to 209 miles electric range
- Smooth 8-speed electrified automatic transmission

Vauxhall PureSense

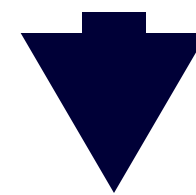

Intelligent automotive technology that's designed to give you unparalleled command and control of your every journey.

- IntelliLux adaptive LED[®] Matrix headlights
 - Advanced park assist
 - Adaptive cruise control
- Lane positioning assistant

Vauxhall PureConnect

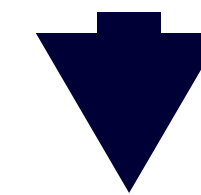

Intuitive connectivity that makes it simple to stay in touch, informed and entertained throughout day.

- Pure Panel
- Wireless phone projection
 - Vauxhall Connect

Choose Your Trim Level

Design



First in the line-up is the wonderfully well-equipped Design.

GS Line



This sporty number in the range comes with stylish red accents and is loaded with even more tech.

Also available as a 100% electric model.

Ultimate



All you could ask for; our Ultimate model has it all.

Also available as a 100% electric model.

Mokka-e Range Highlights

GS Line

Standard features include:

PureSense

- LED headlights and tail lights
- LED daytime running lights
- LED front fog lights
- High beam assist
- Rear parking distance sensors
- Lane departure warning with lane keep assist
- Forward collision alert (low speed)
- Traffic sign recognition
- Driver drowsiness alert
- Automatic emergency city braking
- Six airbags
- Hill start assist
- Remote control ultrasonic security alarm system
- Automatic lighting control with tunnel detection
- Panoramic rear-view camera

PureConnect

- Multimedia Pure Panel Navigation system
 - 10-inch colour touchscreen
 - 12-inch digital instrument cluster
 - Satellite Navigation
 - AM/FM/DAB digital radio
 - Bluetooth®
 - Apple CarPlay/Android Auto™
 - Front USB connection
 - 2 rear USB connections
- Six speakers
- Vauxhall Connect

Comfort and Convenience

- Electronic climate control
- Heated flat bottomed leather-covered steering wheel
- Heated front seats
- Electrically adjustable/heated door mirrors
- Steering wheel audio/phone/cruise controls
- Rain-sensitive windscreen wipers
- Front centre armrest with storage
- Storage pockets on front seat backs
- Automatic anti-dazzle rear-view mirror
- Keyless entry and start

Styling

- 18-inch bi-colour alloy wheels
- Red upper window moulding
- Black Griffin logo and vizer frame
- Black front/rear bumper inserts
- Black roof
- Black headliner
- Dark-tinted rear windows
- Alloy-effect sports pedals

Ultimate

Features over GS Line models:

PureSense

- IntelliLux LED® Matrix headlights with advanced forward lighting
- Front and rear parking distance sensors
- Advanced park assist
- Adaptive cruise control
- Lane positioning assistant
- Forward collision alert (all speed)
- Side blind spot alert with flank guard
- Enhanced automatic emergency city braking
- Automatic high beam assist
- Automatic headlight levelling system

Comfort and Convenience

- Electrically foldable door mirrors
- Alcantara interior seat trim
- Moveable boot floor

Styling

- Chrome-effect front/rear bumper inserts
- Chrome-effect upper window moulding

Mokka Range Highlights

Design

Standard features include:

PureSense

- LED headlights and tail lights
- LED daytime running lights
- High beam assist
- Lane departure warning with lane keep assist
- Traffic sign recognition
- Driver drowsiness alert
- Automatic emergency city braking
- Forward collision alert (low speed)
- Cruise control with intelligent speed limiter
- Six airbags
- Hill start assist
- Remote control central locking

PureConnect

- Multimedia Pure Panel system
 - 7-inch colour touchscreen
 - 7-inch digital instrument cluster
 - AM/FM/DAB digital radio
 - Bluetooth®
 - Front USB connection
- Six speakers

Comfort and Convenience

- Air conditioning
- Flat bottomed leather-covered steering wheel
- Electrically adjustable/heated door mirrors
- Steering wheel audio/phone/cruise controls

Styling

- 16-inch silver alloy wheels
- Body coloured front/rear bumper inserts
- Black painted rear spoiler
- Chrome-effect upper window moulding

GS Line

Features over Design models:

PureSense

- LED front fog lights
- Rear parking distance sensors
- Remote control ultrasonic security alarm system
- Automatic lighting control with tunnel detection
- Panoramic rear-view camera
- Sports switch with engine sound enhancement

PureConnect

- Multimedia Pure Panel Navigation system
 - 10-inch colour touchscreen
 - 12-inch digital instrument cluster
 - Satellite Navigation
 - 2 rear USB connections

Comfort and Convenience

- Electronic climate control
- Heated steering wheel • Heated front seats
- Rain-sensitive windscreen wipers
- Front centre armrest with storage
- Storage pockets on front seat backs
- Automatic anti-dazzle rear-view mirror
- Keyless entry and start

Styling

- 18-inch bi-colour alloy wheels
- Red upper window moulding
- Black Griffin logo and vizor frame
- Black front/rear bumper inserts
- Black roof • Black headliner
- Dark-tinted rear windows
- Alloy-effect sports pedals

Ultimate

Features over GS Line models:

PureSense

- IntelliLux LED® Matrix headlights with advanced forward lighting
- Front and rear parking distance sensors
- Advanced park assist
- Adaptive cruise control
- Lane positioning assistant (auto models only)
- Side blind spot alert with flank guard
- Forward collision alert (all speed)
- Enhanced automatic emergency city braking
- Automatic headlight levelling system
- Automatic high beam assist

PureConnect

- Vauxhall Connect

Comfort and Convenience

- Electrically foldable door mirrors
- Alcantara interior seat trim
- Moveable boot floor

Styling

- Chrome-effect front/rear bumper inserts
- Chrome-effect upper window moulding

Mokka-e GS Line



VX_MOK_33434

GS Line

OTR £30,435*

PureSense

- LED headlights and tail lights
- LED daytime running lights
- LED front fog lights
- High beam assist
- Rear parking distance sensors
- Lane departure warning with lane keep assist
- Traffic sign recognition
- Driver drowsiness alert
- Automatic emergency city braking
- Forward collision alert (low speed)
- Six airbags
- Hill start assist
- Remote control ultrasonic security alarm system
- Automatic lighting control with tunnel detection
- Panoramic rear-view camera

PureConnect

- Multimedia Pure Panel Navigation system
 - 10-inch colour touchscreen
 - 12-inch digital instrument cluster
 - Satellite Navigation
 - AM/FM/DAB digital radio
 - Bluetooth®
 - Apple CarPlay/Android Auto™
 - Front USB connection
 - 2 rear USB connections
- Six speakers
- Vauxhall Connect

Comfort and Convenience

- Electronic climate control
- Heated flat bottomed leather-covered steering wheel
- Heated front seats
- Electrically adjustable/heated door mirrors
- Steering wheel audio/phone/cruise controls
- Rain-sensitive windscreen wipers
- Front centre armrest with storage
- Storage pockets on front seat backs
- Automatic anti-dazzle rear-view mirror
- Keyless entry and start

Styling

- 18-inch bi-colour alloy wheels with red accents
- Red upper window moulding
- Black Griffin logo and vizer frame
- Black front/rear bumper inserts
- Black roof
- Black headliner
- Dark-tinted rear windows
- Alloy-effect sports pedals

*Price shown is after allowing for PiCG (Plug-in Car Grant).

Mokka-e Ultimate



VX_MOK_32604

Ultimate

OTR £30,495*

PureSense

- IntelliLux LED® Matrix headlights with advanced forward lighting
- LED tail lights
- LED daytime running lights
- LED front fog lights
- Automatic high beam assist
- Front and rear parking distance sensors
- Lane departure warning with lane keep assist
- Traffic sign recognition
- Driver drowsiness alert
- Automatic emergency city braking
- Forward collision alert (all speed)
- Six airbags
- Hill start assist
- Remote control ultrasonic security alarm system
- Automatic lighting control with tunnel detection
- Panoramic rear-view camera
- Advanced park assist
- Adaptive cruise control
- Lane positioning assistant
- Forward collision alert (all speed)
- Side blind spot alert with flank guard
- Enhanced automatic emergency city braking
- Automatic headlight levelling system

PureConnect

- Multimedia Pure Panel Navigation system
 - 10-inch colour touchscreen
 - 12-inch digital instrument cluster
 - Satellite Navigation
 - AM/FM/DAB digital radio
 - Bluetooth®
 - Apple CarPlay/Android Auto™
 - Front USB connection
 - 2 rear USB connections
- Six speakers
- Vauxhall Connect

Comfort and Convenience

- Electronic climate control
- Heated flat bottomed leather-covered steering wheel
- Heated front seats
- Electrically adjustable/heated/foldable door mirrors
- Steering wheel audio/phone/cruise controls
- Rain-sensitive windscreen wipers
- Front centre armrest with storage
- Storage pockets on front seat backs
- Automatic anti-dazzle rear-view mirror
- Keyless entry and start
- Alcantara interior seat trim
- Moveable boot floor

Styling

- 18-inch bi-colour alloy wheels
- Chrome-effect upper window moulding
- Chrome-effect front/rear bumper inserts
- Black roof
- Black headliner
- Dark-tinted rear windows
- Alloy-effect sports pedals

*Price shown is after allowing for PiCG (Plug-in Car Grant).

Mokka Design



VX_MOK_33439

Design

OTR from £22,265

PureSense

- LED headlights and tail lights
- LED daytime running lights
- High beam assist
- Lane departure warning with lane keep assist
- Traffic sign recognition
- Driver drowsiness alert
- Automatic emergency city braking
- Forward collision alert (low speed)
- Cruise control with intelligent speed limiter
- Six airbags
- Hill start assist
- Remote control central locking
- Automatic lighting control with tunnel detection

PureConnect

- Multimedia Pure Panel system
 - 7-inch colour touchscreen
 - 7-inch digital instrument cluster
 - AM/FM/DAB digital radio
 - Bluetooth®
 - Front USB connection
- Six speakers

Comfort and Convenience

- Air conditioning
- Flat bottomed leather-covered steering wheel
- Electrically adjustable/heated door mirrors
- Steering wheel audio/phone/cruise controls

Styling

- 16-inch silver alloy wheel
- Body coloured front/rear bumper inserts
- Black painted rear spoiler
- Chrome-effect upper window moulding

Mokka GS Line



VX_MOK_33433

GS Line OTR from £24,640

PureSense

- LED headlights and tail lights
- LED daytime running lights
- LED front fog lights
- High beam assist
- Rear parking distance sensors
- Lane departure warning with lane keep assist
- Traffic sign recognition
- Driver drowsiness alert
- Automatic emergency city braking
- Forward collision alert (low speed)
- Cruise control with intelligent speed limiter
- Six airbags
- Hill start assist
- Remote control ultrasonic security alarm system
- Automatic lighting control with tunnel detection
- Sports switch with engine sound enhancement
- Panoramic rear-view camera

PureConnect

- Multimedia Pure Panel Navigation system
 - 10-inch colour touchscreen
 - 12-inch digital instrument cluster
 - Satellite Navigation
 - AM/FM/DAB digital radio
 - Bluetooth®
 - Front USB connection
 - 2 rear USB connections
- Six speakers

Comfort and Convenience

- Electronic climate control
- Heated flat bottomed leather-covered steering wheel
- Heated front seats
- Electrically adjustable/heated door mirrors
- Steering wheel audio/phone/cruise controls
- Rain-sensitive windscreen wipers
- Front centre armrest with storage
- Storage pockets on front seat backs
- Automatic anti-dazzle rear-view mirror

Styling

- 18-inch bi-colour alloy wheels with red accents
- Black front/rear bumper inserts
- Black painted rear spoiler
- Red upper window moulding
- Black Griffin logo and vizer frame
- Black roof
- Black headliner
- Dark-tinted rear windows
- Alloy-effect sports pedals

Mokka Ultimate



VX_MOK_32603

Ultimate OTR from £29,060

PureSense

- IntelliLux LED® Matrix headlights with advanced forward lighting
- LED tail lights
- LED daytime running lights
- LED front fog lights
- Automatic high beam assist
- Front and rear parking distance sensors
- Lane departure warning with lane keep assist
- Traffic sign recognition
- Driver drowsiness alert
- Automatic emergency city braking
- Forward collision alert (all speed)
- Cruise control with intelligent speed limiter
- Six airbags
- Hill start assist
- Remote control ultrasonic security alarm system
- Automatic lighting control with tunnel detection
- Sports switch with engine sound enhancement
- Panoramic rear-view camera
- Advanced park assist
- Adaptive cruise control
- Lane positioning assistant (auto models only)
- Side blind spot alert with flank guard
- Enhanced automatic emergency city braking
- Automatic headlight levelling system

PureConnect

- Multimedia Pure Panel Navigation system
 - 10-inch colour touchscreen
 - 12-inch digital instrument cluster
 - Satellite Navigation
 - AM/FM/DAB digital radio
 - Bluetooth®
 - Front USB connection
 - 2 rear USB connections
- Six speakers
- Vauxhall Connect

Comfort and Convenience

- Electronic climate control
- Heated flat bottomed leather-covered steering wheel
- Heated front seats
- Electrically adjustable/heated/foldable door mirrors
- Steering wheel audio/phone/cruise controls
- Rain-sensitive windscreen wipers
- Front centre armrest with storage
- Storage pockets on front seat backs
- Automatic anti-dazzle rear-view mirror
- Keyless entry and start
- Alcantara interior seat trim
- Moveable boot floor

Styling

- 18-inch bi-colour alloy wheels
- Chrome-effect front/rear bumper inserts
- Black painted rear spoiler
- Chrome-effect upper window moulding
- Black roof
- Black headliner
- Dark-tinted rear windows
- Alloy-effect sports pedals

This vehicle is covered by our Price Protection Guarantee. See 'Further Information' page for details.

Mokka-e Prices

	Pack Code	Price (£)	VAT (£)	Total (£)	On-the-road RRP before PiCG (£)	On-the-road RRP after PiCG (£)	Financial Year 2022/23 BiK 20% (£)	WLTP Combined CO ₂ (g/km) – pack code	Insurance groups
GS Line									
Electric Propulsion (136PS) auto	MM76 9CQ1	25,983.33	5,196.67	31,180.00	31,935.00	30,435.00	10.62	0	22E
Ultimate									
Electric Propulsion (136PS) auto	MH76 9CQ1	26,033.33	5,206.67	31,240.00	31,995.00	30,495.00	10.63	0	23E

Please note: On-the-road recommended retail prices (RRP) include number plates and delivery to Retailer of £700.00 (inc. £116.67 VAT), 12 months' Vehicle Excise Duty and new vehicle first registration fee of £55.00. Excludes fuel and insurance. Company Car Benefit in Kind (BiK) rates are monthly based on the standard paint price. Price has been calculated using manufacturer estimates and includes a £1,500.00 OZEV grant which has been deducted from the price of the vehicle (OZEV Grant not available in the Isle of Man). Mokka-e is expected to be a qualifying model for this grant subject to acceptance by OZEV. Please check with your Retailer for latest status. The grant is a government incentive and is subject to withdrawal prior to delivery of your vehicle. Retailers may be required to carry out more than one credit check during the course of the order process. You may be required to place a deposit when placing your order with your supplying Retailer. In the event of a price change, deposit refunds will be governed by your supplying Retailer's policy and as such must be discussed with the supplying Retailer.

Mokka-e is not covered by our Price Protection Guarantee. See 'Further Information' page for details.

Mokka Prices

	Pack Code	Fuel Type	Price (£)	VAT (£)	Total (£)	On-the-road RRP (£)	Financial Year 2022/23 BiK 20% (£)	WLTP Combined CO ₂ (g/km)* - pack code	Insurance groups
Design									
1.2 (100PS) Turbo	MC76 EU61	Petrol	17,766.67	3,553.33	21,320.00	22,265.00	106.42	125	tba
1.2 (130PS) Turbo	MC76 EP61	Petrol	18,766.67	3,753.33	22,520.00	23,465.00	116.08	126	tba
1.2 (130PS) Turbo auto	MC76 ES81	Petrol	19,908.33	3,981.67	23,890.00	24,875.00	131.13	137	tba
1.5 (110PS) Turbo D	MC76 HZ61	Diesel	19,266.67	3,853.33	23,120.00	24,065.00	107.18	114	tba
GS Line									
1.2 (100PS) Turbo	MS76 EU61	Petrol	19,745.83	3,949.17	23,695.00	24,640.00	121.97	128	tba
1.2 (130PS) Turbo	MS76 EP61	Petrol	20,745.83	4,149.17	24,895.00	25,840.00	127.97	126	tba
1.2 (130PS) Turbo auto	MS76 ES81	Petrol	22,079.17	4,415.83	26,495.00	27,480.00	145.03	137	tba
1.5 (110PS) Turbo D	MS76 HZ61	Diesel	21,245.83	4,249.17	25,495.00	26,440.00	122.23	116	tba
Ultimate									
1.2 (130PS) Turbo	MU76 EP61	Petrol	23,429.17	4,685.83	28,115.00	29,060.00	144.07	126	tba
1.2 (130PS) Turbo auto	MU76 ES81	Petrol	24,762.50	4,952.50	29,715.00	30,700.00	162.20	137	19E
1.5 (110PS) Turbo D	MU76 HZ61	Diesel	23,929.17	4,785.83	28,715.00	29,660.00	137.27	116	16E

Mokka's petrol and diesel engines meet the Real Driving Emissions Step 2 (RDE2) standards.

*Fuel consumption and CO₂ figures are determined according to the WLTP test cycle. CO₂ figures, BiK values and RRP pricing shown above are for a standard vehicle without any additional optional equipment. CO₂ figures are used to calculate Vehicle Excise Duty (VED) for the first registration of the vehicle and BiK. The addition of optional extras could increase the certified CO₂ emission output. This in turn may affect the amount of VED payable upon registration, and, for company car drivers, the P11D value and the amount of Benefit in Kind (BiK) tax payable. Figures shown are for comparison purposes and should only be compared to the fuel consumption and CO₂ values of other cars tested to the same technical standard. The fuel consumption achieved, and CO₂ produced, in real world conditions will depend upon a number of factors including, but not limited to: the accessories fitted (pre and post registration); variations in weather; driving styles and vehicle load. The WLTP (Worldwide Harmonised Light Vehicles Test Procedure) is used to measure fuel consumption and CO₂ figures. Full data relating to WLTP test cycles can be found at: www.vauxhall.co.uk/wltp

Please note: On-the-road recommended retail prices (RRP) include number plates and delivery to Retailer of £700.00 (inc. £116.67 VAT), 12 months' Vehicle Excise Duty and new vehicle first registration fee of £55.00. Excludes fuel and insurance. Company Car Benefit in Kind (BiK) rates are monthly based on the standard paint price. On-the-road prices feature a VED based on preliminary CO₂ information.

PureSense

Standard Features – The following features are standard across the entire Mokka range.
Specific features by model are outlined in the separate tabular information.

Cruise control with speed limiter

With steering wheel mounted controls. Enables you to maintain a constant speed, making it ideal for economical motorway driving.

Front camera system

A range of class-leading driver assistance and safety features are controlled by the front camera system.

Forward collision alert

The system operates automatically from 3mph and gives an audible warning as well as a visual warning when approaching another vehicle too quickly.

Automatic emergency city braking

The system works automatically in conjunction with forward collision alert, at speeds between 3mph and 53mph, and detects both vehicles and pedestrians.

Speed sign recognition

Detects and then displays speed limits, reducing uncertainty and the risk of speeding.

- Recognises different speed signs, including temporary speed restrictions
- Displays reminder in the instrument cluster

Driver drowsiness alert

The system monitors driving time and driving behaviour to help prevent accidents caused by tiredness.

Lane departure warning with lane keep assist

If the driver has not actively steered or signalled, the lane departure warning system provides gentle steering correction and warns when the car moves outside of lane markings at speeds above 40mph.

- Warning light in instrument cluster
- Audible warning
- Facia on/off switch

Please note, Vauxhall driver assistance systems are intended to support the driver within the system-imminent limitations. The driver remains responsible for the driving task at all times.

Model Specific Features

	Electric models		Design	Petrol models	
	GS Line	Ultimate		GS Line	Ultimate
Driver Assistance					
Forward collision alert (low speed)	●		●	●	
Forward collision alert (all speed)		●			●
Lane positioning assistant		●			auto only
Adaptive cruise control		●			●
Side blind spot alert and flank guard		●			●
Enhanced automatic emergency city braking		●			●
Rear parking distance sensors	●			●	
Front and rear parking distance sensors		●			●
Panoramic rear-view camera	●	●		●	●
Advanced park assist		●			●
Sports switch with engine sound enhancement				●	●

PureConnect

Standard Features – The following features are standard across the entire Mokka range.
Specific features by model are outlined in the separate tabular information.

Pure Panel Digital Display

Pure Panel technology makes driving more intuitive, with a flowing design that presents the information you need. With up to a 10-inch infotainment touchscreen and 12-inch digital instrument cluster right in front of you, you can stay focused on the road ahead.

EV information display

- Powerflow display – Informs drivers on the current state of charge
- Charge display – displays an image of the charge port with the corresponding LED charge indication lights
- e-Save – enables the driver to determine how much battery energy needs to be conserved to ensure that the vehicle reaches its destination when in a zero emission zone
There are three options:
 - 6 mile/12 mile range reserve/Maximum reserve
- Statistics – The Statistics display the average consumption data over a period of time using colour coded graphs
- **Green:** Energy recovered by braking phases and partial recharging by the petrol engine (kWh/mile)
- **Blue:** Energy consumed by the vehicle directly by the battery (kWh/mile)
- **Orange:** Fuel consumption (mpg)

Digital instrumentation

- Digital speedometer and rev counter
- Satellite Navigation display

- Digital fuel gauge with low fuel level warning light
- Digital water temperature gauge with warning light
- Shift-up/down indication light – Indicates when to change gear for optimum fuel economy

Driver information display (centrally located in digital instrument cluster)

- Total mileage • Service-due indicator
- Oil life • Tyre pressure monitoring system

Multi-function trip computer (displayed on digital instrument cluster)

- Trip mileage • Vehicle range based on remaining fuel
- Average speed • Average fuel economy
- Instantaneous fuel economy • Driving time

Digital central facia display (format dependent on infotainment unit)

- Audio information
- Digital clock with automatic RDS time adjustment
- Outside air temperature with ice warning function
- Additional features dependent on infotainment unit



Model Specific Features

	Electric models		Design	GS Line	Ultimate
	GS Line	Ultimate			
Driver Information					
7-inch digital instrument cluster (centrally located in instrument panel)			●		
12-inch digital instrument cluster (centrally located in instrument panel)	●	●		●	●

Standard Features – Vauxhall Connect* is the new way to stay connected while on the road. Smart technology systems and related services keep our drivers safe and provide an exciting, efficient yet safe trip. Activating Vauxhall Connected Services is easy, just visit Vauxhall Connect Store or download MyVauxhall app.

Peace of mind

- Emergency call (SOS e-call)
- Breakdown call (b-call)
- Vehicle status and information**
- Maintenance alerts, fuel level, average fuel consumption and mileage



Vauxhall SOS

In the event of a breakdown or accident, you can count on Vauxhall Connect as your car has its own SIM card installed. If something happens that means there may have been an accident – say, the airbags are inflated or the pre-tensioners on the seatbelts are activated – an automatic message will go off to the emergency services, with details of your location. Vauxhall Connect SOS can be activated manually too – just press the button and you'll be put straight through to the emergency services on the system's integrated phone. So, if you have an accident, or see one, it only takes a few seconds to call for help.

Got a problem with your car but don't need the emergency services? Just press the Vauxhall Connect Assistance button and you'll be connected to our control centre over the system's integrated phone.

Convenience

- E-remote control (Mokka-e only)**
- Remote check of battery level, programming and charge management
- Pre-conditioning of vehicle temperature



E-remote

Check and manage your electric/hybrid vehicle range remotely and in real time using your smartphone. With MyVauxhall you can check the charge and range of your vehicle at any time, and if you're plugged into a charging point, you're even able to control charging when you're far away. To offer peace of mind, you can be alerted when the battery is full or the charging is interrupted.

The remote pre-conditioning feature allows you to warm or cool the vehicle to an optimal temperature before starting your journey. With your comfort in mind, this feature allows you to maximise range if your vehicle is on charge, by taking energy from the source, rather than the battery.

This service is supplied free of charge by Vauxhall for the life of the vehicle.

Drive Smart

- Live navigation[†] (subscription included for three years) with on-line traffic, fuel prices and parking information, Points Of Interest (POI) search and weather
- Trip and drive management**
- Timestamping of trips, trip details, last vehicle position, guide-to-car and more



Live Navigation Plus[†]

Vauxhall's fully integrated navigation system helps you stay informed, providing real-time information from the leading European GPS provider, TomTom[®]. It can be operated using natural voice recognition, meaning your eyes need never leave the road.

Vauxhall Live Navigation Plus is included free of charge for three years and can then be renewed at a cost.

- TomTom[®] services
- Real time traffic news
- Parking prices and availability
- Weather forecast on your journey
- Natural voice control
- Fuel prices at petrol stations
- Search for charging stations
- Quick search for addresses and points of interest
- Road safety alerts

*Standard on Ultimate models and all Mokka-e models only. Subject to subscription – after you have taken delivery of your vehicle, please subscribe on: connect.vauxhall.co.uk **via MyVauxhall App.

[†]Standard on Nav models only. Additional terms and conditions apply to connected services, including customer acceptance of location sharing prior to activation.

Standard Features

Multimedia with 7-inch touchscreen

Standard on Design models

Onboard features:

- 7-inch colour touchscreen
- DAB Digital radio
- RDS with Traffic Programme
- AM/FM stereo radio with 36 station presets
- Six speakers

Media connections:

- USB connection
- Bluetooth® A2DP audio streaming (Advanced Audio Distribution Profile)

Mobile phone portal:

- Bluetooth® connectivity
- Vehicle microphone
- Handsfree calls via steering wheel controls
- Phone book access – Contacts/last calls/missed calls etc. are mirrored on the display and are easily navigated using the touchscreen (features dependent on mobile phone).
- SMS read out and reply

Smartphone interface:

- Apple CarPlay • Android Auto™
- Smartphone projection that allows operations via voice command, touchscreen and buttons to control apps and music playback

Additional features:

- Steering wheel mounted audio controls
- Flexible roof-mounted aerial

Multimedia Navi Pro with 10-inch touchscreen

Standard on GS line and Ultimate models

Standard on Mokka-e models

Features as Multimedia, with the addition of:

- 10-inch colour touchscreen
- Satellite navigation system
- 2D/3D street level mapping
- European coverage
- Points-of-interest search
- Map updates via USB



Please note that compatibility and certain functions may be different depending on the type of device and operating system you're using with the Multimedia systems. Apple CarPlay is a trademark of Apple Inc. Apple and iPhone are trademarks of Apple Inc., registered in the U.S. and other countries. Android is a trademark of Google Inc, also registered in the U.S. and other countries.

Please note, Apple CarPlay screen illustrated on 10-inch colour touchscreen on multimedia Navi Pro audio unit.

Comfort and Convenience

Standard Features – The following features are standard across the entire Mokka range.
Specific features by model are outlined in the separate tabular information.

Interior Convenience

- Front 12-volt electrical accessory socket
- Driver's and front passengers sunvisors incorporating vanity mirrors with covers
- Dipping rear-view mirror
- Reach and rake-adjustable steering
- Steering wheel mounted audio controls
- Front USB connection

Heating and Ventilation

- Air recirculation facility
- Cabin particulate filter – Removes dust, airborne particles and pollen
- Four-speed fan
- Illuminated controls
- Four adjustable facia vents
- Windscreen demist vents
- Side window demist vents

Interior Storage

- Centre console with two cup holders at front and one in rear
- Interior courtesy light
- Front map reading lights
- Luggage compartment lighting
- Door pockets with two-litre capacity

Model Specific Features

	Electric models		Design	Petrol models	
	GS Line	Ultimate		GS Line	Ultimate
Interior Convenience					
Front centre armrest with storage	●	●		●	●
Automatically dimming anti-dazzle rear-view mirror	●	●		●	●
Storage pockets on front seat backs	●	●		●	●
2 rear USB connections	●	●		●	●
Moveable boot floor		●			●
Heating and Ventilation					
Air conditioning			●		
Electronic climate control	●	●		●	●
Heated steering wheel	●	●		●	●
Heated front seats	●	●		●	●

Standard Features – The following features are standard across the entire Mokka range.
 Specific features by model are outlined in the separate tabular information.

Luggage Area

- Luggage compartment cover
- Illuminated load area
- Fully carpeted load area
- Interior tailgate handle
- Four load restraint lashing eyes
- Twin gas-assisted tailgate struts

Door mirrors

- Twin electrically adjustable/heated door mirrors

Windows

- Solar heat-absorbing windscreen and windows
- Electrically operated front and rear windows with safety autoreverse and one-touch up/down facility
- Heated rear window

Wipers

- Two-speed windscreen wipers with variable intermittent wipe
- Intermittent rear window wash/wipe

Model Specific Features

	Electric models		Design	GS Line	
	GS Line	Ultimate		GS Line	Ultimate
Exterior Convenience					
Rain-sensitive windscreen wipers	●	●		●	●
Keyless entry and start	●	●		●	●
Electrically foldable door mirrors		●			●

Design



Steering wheel:

- Three-spoke design
- Flat bottomed leather-covered steering wheel
- Satin chrome-effect bezel

Facia and door trim:

- Black facia with silver trim inserts
- Instrument panel bar Light Gravel
- Atlantis black trim inserts on front doors
- Chrome-effect interior door handles

Seating:

- Driver's seat (six-way adjustable):
 - Height
 - Reach
 - Backrest
- Front passenger's seat (four-way adjustable)
 - Reach
 - Backrest

Seat trim:

- Jet black fabric seat trim inserts
- Jet black fabric side bolsters

GS Line



Steering wheel:

- Three-spoke design
- Heated flat bottomed leather-covered steering wheel
- Satin chrome-effect bezel

Facia and door trim:

- Black facia with red trim inserts
- Instrument panel bar Light Gravel
- Atlantis black trim inserts on front doors
- Chrome-effect interior door handles

Seating:

- Driver's and front passenger's seat (six-way adjustable):
 - Height
 - Reach
 - Backrest
- Heated front seats

Seat trim:

- Minstral and Jet black fabric leather-effect seat trim inserts
- Jet black fabric side bolsters

Ultimate



Steering wheel:

- Three-spoke design
- Heated flat bottomed leather-covered steering wheel
- Satin chrome-effect bezel

Facia and door trim:

- Black facia with silver trim inserts
- Instrument panel bar Polar Silver
- Atlantis black trim inserts on front doors
- Chrome-effect interior door handles

Seating:

- Driver's and front passenger's seat (six-way adjustable):
 - Height
 - Reach
 - Backrest
- Heated front seats

Seat trim:

- Black Alcantara seat trim inserts
- Black premium leather-effect side bolsters

Ultimate – Leather (extra-cost option)



Steering wheel:

- Three-spoke design
- Heated flat bottomed leather-covered steering wheel
- Satin chrome-effect bezel

Facia and door trim:

- Black facia with silver trim inserts
- Instrument panel bar Polar Silver
- Atlantis black trim inserts on front doors
- Chrome-effect interior door handles

Seating:

- Driver's and front passenger's seat (six-way adjustable):
 - Height
 - Reach
 - Backrest
- Heated front seats
- Driver's massage function

Seat trim:

- Black Sienna perforated leather seat trim inserts

Optional seating priced at £600 including VAT

Safety and Security

Standard Features – The following features are standard across the entire Mokka range.

Airbags

- Driver’s airbag
- Front passenger’s airbag
- Front seat side-impact airbags
- Full-size curtain airbags

Seating

- Three height adjustable rear seat head restraints

Seatbelts

- Inertia-reel lap and diagonal seatbelts
- Seatbelt unfastened’ audible warning and warning light

Braking

- Hill start assist

Child safety

- Deactivation switch for front passenger’s front and side-impact airbags
- ISOFIX child seat mountings incorporating top tether anchor points located on outer rear seats (does not include child seat)
- Child-proof locks on rear doors

Security

- ‘Key left in ignition’ audible warning
- Electronically protected audio equipment
- Engine deadlock immobiliser
- Visible Vehicle Identification Number (VIN)
- Locking wheel bolts for alloy wheels
- Freewheeling door locks

Remote control central locking

- Operates on doors, tailgate and fuel filler flap
- Deadlocking
- Central locking activation switch on driver’s door

Tyre pressure

- Tyre pressure monitoring system

Model Specific Feature

	Electric models		Design	Hybrid models	
	GS Line	Ultimate		GS Line	Ultimate
Security					
Remote control ultrasonic security alarm system	●	●		●	●



Hill start assist.



ISOFIX child seat mountings.



Automatic emergency city braking (see PureSense page for details).

Lighting

Standard Features – The following features are standard across the entire Mokka range.

Exterior Lighting

- LED daytime running lights
- LED side repeat indicators
- Lights-on audible warning – When driver’s door is opened an audible warning sounds to alert the lights have been left on

- LED tail lights
- Rear fog light
- Reversing light
- Hazard warning lights

Interior Lighting

- Central front courtesy light
- Central rear courtesy light
- Fade up/fade down

Model Specific Features

	Electric models		Design	GS Line	Ultimate
	GS Line	Ultimate			
Exterior Lighting					
LED headlights	●		●	●	
IntelliLux Matrix LED® headlights with advanced forward lighting		●			●
Automatic lighting control with tunnel detection	●	●		●	●
High beam assist	●		●	●	
High beam assist with anti-glare		●			●
LED front fog lights	●	●		●	●
Manual headlight levelling system	●		●	●	
Automatic headlight levelling system		●			●



VX_MOK_31269

LED headlight.



VX_MOK_31119

LED tail lights.



VX_MOK_31246

IntelliLux adaptive LED® Matrix headlights.

Styling

Standard Features – The following features are standard across the entire Mokka range.
Specific features by model are outlined in the separate tabular information.

Exterior Styling

- Body-colour front and rear bumpers
- Body-colour door handles
- Black door mirror housings
- Integrated black tailgate spoiler

Model Specific Features

	Electric models		Design	GS Line	Ultimate
	GS Line	Ultimate			
Exterior Styling					
Dark-tinted rear windows	●	●		●	●
Black Griffin logo and vizer frame	●			●	
Chrome-effect Griffin logo and vizer frame		●	●		●
Body coloured front/rear bumper inserts			●		
Black front/rear bumper inserts	●			●	
Chrome-effect front/rear bumper inserts		●			●



VX_MOK_31256

Chrome-effect Griffin logo and vizer frame.



VX_MOK_31318

Black door mirrors with puddle lights.



VX_MOK_31136

Rear styling.

	Electric models		Design	Electric models	
	GS Line	Ultimate		GS Line	Ultimate
Roof Colours					
Body-coloured roof	No-cost	No-cost	●	No-cost	No-cost
Black roof	●	●		●	●
White roof*	£300	£300		£300	£300
Red roof**	£300			£300	
Bonnet Colours					
Black bonnet†	£200	£200		£200	£200
Window Moulding Colours					
Chrome-effect window moulding		●	●		●
Red upper window moulding††	●			●	
Black upper window moulding‡	No-cost			No-cost	



VX_MOK_31270

Black roof (22T)



VX_MOK_31271

White roof (03T)*



VX_MOK_31272

Red roof (34V)**



VX_MOK_31273

Black bonnet (CNP)

*Optional at extra cost including VAT. Not available with White Jade/Voltaic Blue/Mamba Green. **Optional at extra cost including VAT. Not available with Power Red/Voltaic Blue/Mamba Green body colours.
 †Optional at extra cost including VAT. ††Not available with Mamba Green/Power Red/Voltaic Blue body colours/white roof/red roof. ‡Standard with Power Red body colour.

Exterior Colours

Jade White (G2o)*
Brilliant paint



VX_MOK_31264

Quartz Grey (G4i)**
Two-coat metallic paint **£600**



VX_MOK_31268

Voltaic Blue (G6l)†
Two-coat metallic paint **£600**



VX_MOK_31265

Diamond Black (G7o)**
Two-coat metallic paint **£600**



VX_MOK_31267

Mamba Green (GGl)†
Two-coat premium metallic paint **£700**



VX_MOK_31269

Power Red (GD6)**
Two-coat premium metallic paint **£700**





VX_MOK_31266

The colours reproduced may vary slightly from the actual paint colour. As a result they should be used as a guide only. Your Vauxhall Retailer has a comprehensive display of our paint samples.

*Standard exterior paint. **Optional at extra cost including VAT. †Optional at extra cost including VAT. Not available on GS Line models.

Wheels and Tyres

		Electric models				
		GS Line	Ultimate	Design	GS Line	Ultimate
 VX_MOK_31304_WR6	16-inch silver alloy wheels • 215/65 R 16 Tyres • Emergency tyre inflation kit (in lieu of spare wheel)			●		
 VX_MOK_31279_RV6	18-inch bi-colour alloy wheels with red accents • 215/55 R 18 tyres • Emergency tyre inflation kit (in lieu of spare wheel)	●			●	
 VX_MOK_31314_RSX	18-inch bi-colour alloy wheels • 215/55 R 18 tyres • Emergency tyre inflation kit (in lieu of spare wheel)	No-cost	●		No-cost	●
Provision for spare wheel fitment (spare wheel is Retailer-fit)				£20*	£20*	£20*

*Optional at extra cost including VAT.

Mokka-e Specifications

Single-speed electronic drive selector

As the motor is an all-electric single-speed drive unit, there is no need for multiple gears. Instead, the shifter lets the driver select from the following:

- Park
- Reverse
- Neutral
- Drive
- Braking (for increased regenerative braking)

Drive Mode Selector

The driver can determine the driving style through selecting one of the following modes:

- **Sport:** for a dynamic drive with a responsive throttle and the highest top speed and torque
- **Normal:** for a balanced drive that offers a compromise between performance and energy efficiency
- **ECO:** for maximum range and energy efficiency. The ECO mode deactivates all unnecessary energy-consuming features and reduces the top speed, torque and overall performance

Drivetrain	Mokka-e
CO ₂ emissions	0g/km
Maximum power	100kW (136PS)
Maximum torque	260Nm (192lb. ft.)
Acceleration 0-60mph	9.2 sec
Maximum speed	93mph
Transmission	Automatic electric drive with fixed gear ratio
Service interval	Initial inspection at 8,000 miles/1 year (whichever comes sooner). Thereafter 16,000 miles/2 years (whichever comes sooner)

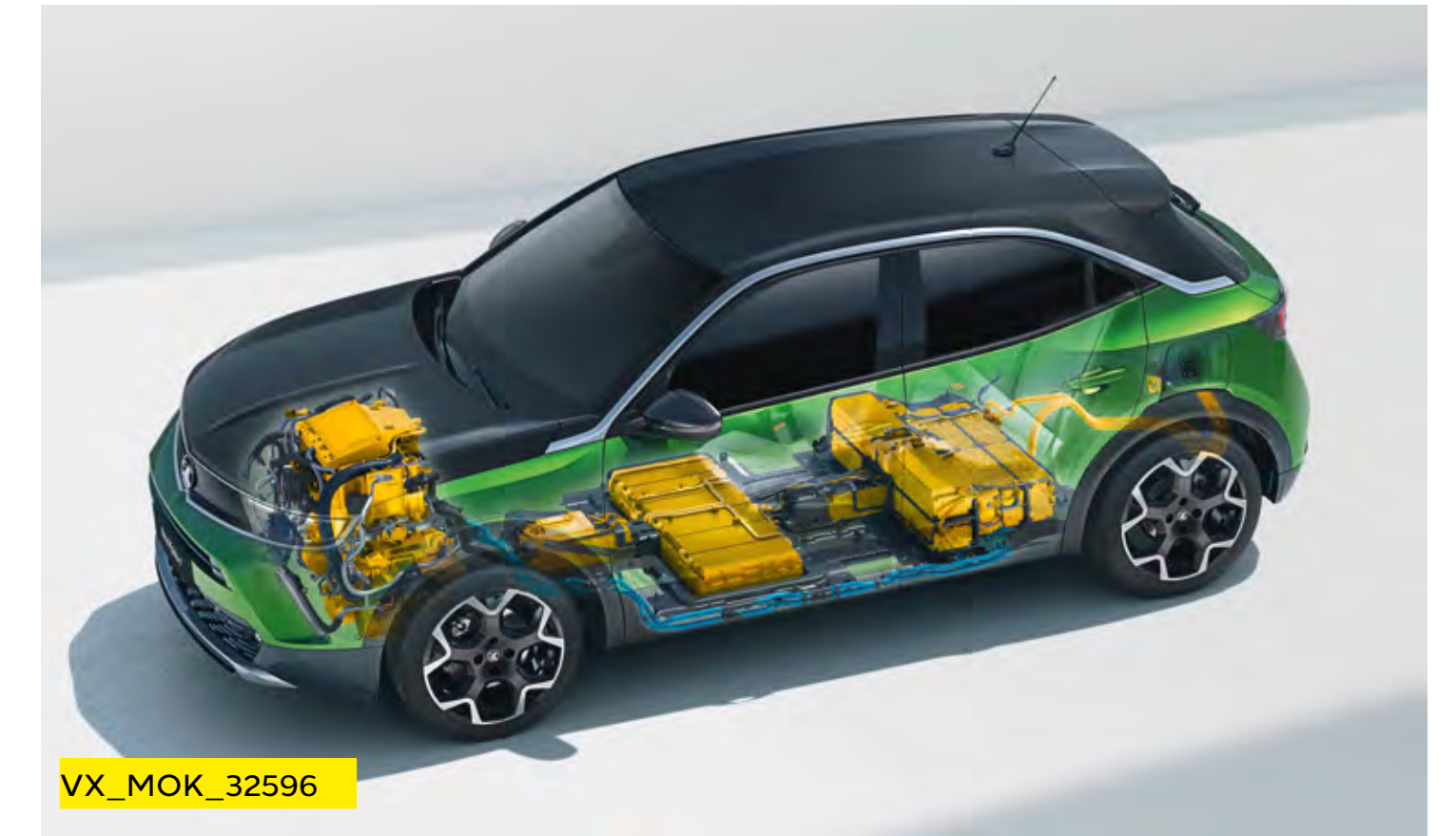

Mokka-e Specifications

Charging

Mokka-e comes fitted with an 11kW on-board charger and mode 3 cable.

The charging flap's Padlock LED lights up when the cable is correctly plugged in and locked and then acts as a user interface to show the charging status via coloured LED lights:

- **White:** welcome light that helps to light up the area, especially useful in dark conditions
- **Flashing green:** charging in progress
- **Solid green:** charging complete
- **Solid blue:** delayed charging toggled; changes to flashing green when charging commences
- **Solid red:** malfunction

The driver may also choose from two settings:

- **Immediate charging (the standard setting):** Starts charging as soon as the vehicle is docked for charging
- **Delayed charging:** This is especially useful for when cheaper electric rates are desired, e.g. charging at night. Simply enter a charging start time

Please note, EV range assumes that vehicle has been pre-conditioned prior to journey. This function can be accessed either via MyVauxhall App (standard with all Mokka-e) or by using the Multimedia Navi Pro infotainment system.

Charging		
Supply	Socket	Charge Time (0-100%)
AC current - Domestic 3 pin socket (2.3kW)	Type 2	21h 45m
AC current - Home wallbox or public charger (7kW)	Type 2	7h 30m
AC current - Public charger (11kW)	Type 2	5h
DC current - Rapid charger (100kW)	CCS	30m (0-80%)

Battery	
Battery capacity	50kWh
AC on-board charger speed	11kW
EV range (WLTP high)	209 miles
Energy consumption (Combined low/high)	15.8-16.2kWh/100km
Battery warranty	8 years/100,000 miles/70% capacity



Petrol Engines

	1.2 (100PS) Turbo	1.2 (130PS) Turbo with 6-speed manual	1.2 (130PS) Turbo with 8-speed automatic
Capacity	1199cc	1199cc	1199cc
Maximum power	100PS (75kW) @ 5500rpm	130PS (96kW) @ 5500rpm	130PS (96kW) @ 5500rpm
Maximum torque	205Nm (151lb.ft.) @1750rpm	230Nm (169lb.ft.) @1750rpm	230Nm (169lb.ft.) @1750rpm
Configuration	3 cylinders, 4 valves per cylinder, double overhead camshafts	3 cylinders, 4 valves per cylinder, double overhead camshafts	3 cylinders, 4 valves per cylinder, double overhead camshafts
Fuel/induction system	Turbocharger with intercooler. Multi-point sequential fuel injection	Turbocharger with intercooler. Multi-point sequential fuel injection	Turbocharger with intercooler. Multi-point sequential fuel injection
Emission compliance	Euro 6d	Euro 6d	Euro 6d
Service interval	12,500 miles or 1 year (whichever occurs sooner)	12,500 miles or 1 year (whichever occurs sooner)	12,500 miles or 1 year (whichever occurs sooner)

Diesel Engine

	1.5 (110PS) Turbo D
Capacity	1499cc
Maximum power	110PS (81kW) @ 3500rpm
Maximum torque	250Nm (184lb.ft.) @ 1750rpm
Configuration	4 cylinders, 4 valves per cylinder, double overhead camshafts
Fuel/induction system	Turbocharger with intercooler. Variable Valve Timing (VVT). Spark ignited direct injection (SIDI)
Emission compliance	Euro 6d
Service interval	20,000 miles or 1 year (whichever occurs sooner)

Specifications

Transmission

- Front-wheel drive
- Six-speed manual gearbox
 - Available on 1.2 (100PS) Turbo/1.2 (130PS) Turbo/1.5 (110PS) Turbo D models.
- Eight-speed automatic transmission
 - Available on 1.2 (130PS) Turbo models.

Steering

- Single pinion electrical power steering

Brakes

- Anti-lock Braking System (ABS)
- Electronic brakeforce distribution
- Emergency brake assist
- Cornering brake control
- Straight line stability control

Petrol/diesel engines

Front ventilated discs: 283mm diameter

Rear drums: 249mm diameter

Electric engine

Front ventilated discs: 302mm diameter

Rear discs: 268mm diameter

Fuel tank capacity

– 1.2 (100PS) Turbo/1.2 (130PS) Turbo 44 litres (9.7 gallons)

– 1.5 (110PS) Turbo D 41 litres (9.0 gallons)

AdBlue® Tank Capacity

– 15 litres (3.3 gallons)

Start/Stop technology

Mokka's Start/Stop system offers real benefits by improving fuel economy and reducing CO₂ emissions, particularly in town. It does this by automatically stopping the engine when you come to a standstill, and then restarting as you prepare to move off.

Before automatically stopping the engine a number of system checks are carried out to ensure that it is both safe and practical to do so. To ensure safety, the driver must depress the clutch pedal, shift in to neutral, and then release the clutch pedal.

System checks carried out before Auto Stop activates include:

- Start/Stop system is not manually deactivated via the facia button
- Sufficient brake vacuum is available to prevent the car rolling down an incline
- Battery is in good condition and charged
- Outside air temperature and engine temperature are above specified minima
- Electronic climate control (where fitted) is not in maximum heating or maximum cooling mode
- Self-cleaning function of the diesel particulate filter is not active

If all of these conditions are satisfied then the vehicle will Auto Stop.

When you are ready to pull away from standstill, Auto Restart is activated by depressing the clutch pedal.

Whilst at a standstill the vehicle is continually monitored. If necessary, the engine will automatically be restarted. Conditions that would initiate an Auto Restart include:

- Low battery level
- Brake vacuum below specified minimum
- Start/Stop system is manually deactivated
- Stationary for 5.5 minutes

Performance, Fuel Economy and Emissions

	Performance (manufacturer's figures)		Fuel economy mpg (litres/100km) [#]		CO ₂ emissions g/km [#]		Vehicle Excise Duty*		BiK rates from - 2022/23 tax year
	Maximum speed (mph)	Acceleration 0-60mph (sec)	Combined Low	Combined High	Combined Low	Combined High	First year rate	Standard rate	
1.2 (100PS) Turbo	116	10.6	49.6 (5.7)	51.4 (5.5)	124	128	£190	£165	30%
1.2 (130PS) Turbo	125	9.1	50.4 (5.6)	51.4 (5.5)	123	126	£190	£165	30%
1.2 (130PS) Turbo automatic	124	9.2	47.1 (6.0)	47.9 (5.9)	133	137	£230	£165	32%
1.5 (110PS) Turbo D	118	10.8	62.8 (4.5)	65.7 (4.3)	114	117	£190	£165	27%

Weights and Towing Data^{kg}

	Gross vehicle weight	Maximum towing weights Trailer with brakes (without brakes)
1.2 (100PS) Turbo	1700	1200 (620)
1.2 (130PS) Turbo	1715	1200 (620)
1.2 (130PS) Turbo automatic	1740	1200 (640)
1.5 (110PS) Turbo D	1750	1200 (640)

[#]Figures shown are for comparison purposes and should only be compared to the fuel consumption and CO₂ values of other cars tested to the same technical standard. The fuel consumption achieved, and CO₂ produced, in real world conditions will depend upon a number of factors including, but not limited to: the accessories fitted (pre and post registration); variations in weather; driving styles and vehicle load. The WLTP (Worldwide Harmonised Light Vehicles Test Procedure) is used to measure fuel consumption and CO₂ figures. The CO₂ figures display a range to reflect the highest value for the highest emitting version with all available options added, through to a minimum value to represent the lowest emitting version in standard specification.

*Correct at time of publication.

Please note: Gross vehicle weight is the total permissible weight of the vehicle including passengers and their luggage. The **maximum roof rack loading** should not exceed 70kg. The **maximum towing weights** are based on the ability of the car, with two occupants of 75kg each, to restart on a 12% gradient, which is approximately 1 in 8.3, at sea level. The permitted trailer load applies up to the specified incline and up to an altitude of 1000 metres above sea level. The permissible gross train weight decreases by 10% for every 1000 metres of additional altitude. At altitudes above 1500 metres, the engine output may drop with a corresponding reduction in towing capability. Any extra weight, such as luggage or additional passengers, should be deducted from the maximum towing weight. With a trailer fully loaded, **maximum noseweight** should not exceed 55kg. Always fit Vauxhall towing attachments and accessories available from your Vauxhall Retailer. They are designed specifically for Vauxhall models and carry a 12-month guarantee. During trailer towing do not exceed a maximum speed of 60mph. This speed limit is also applicable in countries with higher permitted speeds for trailer-vehicle combinations. Pay attention to the local speed limits. For trailers with low driving stability and caravans the use of an oscillation damper is strongly recommended.

Dimensions and Capacities All measurements in mm (inches) unless stated otherwise.



Loadspace Dimensions	Mokka	Mokka-e
Maximum length behind rear seats	667 (26.3)	667 (26.3)
Maximum length rear seats folded	1418 (55.8)	1418 (55.8)
Maximum width	1021 (40.2)	1021 (40.2)
Maximum height	780 (30.7)	780 (30.7)

Luggage Capacities Litres (cu.ft.)	Mokka	Mokka-e
Rear seats up (under luggage compartment cover)	350 (12.37)	310 (10.9)
Rear seats folded (to roof)	1105 (39.0)	1060 (37.4)

Accessories

Safety Total (inc. VAT)

Spare wheel kit with 16-inch emergency wheel and tool kit (petrol and diesel models only) ¹	£167
Philips ADR620 dash cam	£109
Front parking sensors	£390
Rear parking sensors	£407
Child seats ²	
- Group 0 (0-13kg) – Britax Romer Baby Safe	£239
- ISOFIX Base, Rear-facing for Britax Romer Baby Safe	£251
- Group 2/3 (15-36kg) – Britax Romer KIDFIX 2 R	£317
- Group 2/3 (15-36kg) – Britax Romer KIDFIX XP	£352
- Group 3 (22-36kg) – Booster Seat without Seatback	£76
Safety Pack – first aid kit, hi-vis vest and warning triangle	£16
Warning triangle	£9
Hi-vis safety vest – adult	£4
Hi-vis safety vest – child 3-6 years (42cm)	£4
Hi-vis safety vest – child 7-12 years (52cm)	£4
First aid kit	£15
Emergency seat belt cutter and hammer	£19
Fire extinguisher (1kg) with strap	£33
Under seat bracket for fire extinguisher	£48

Protection Total (inc. VAT)

Floor mats (set of 4)	
- Carpet	£43
- Rubber	£53
- Velour	£74
Rear seat cover	£40
Boot area cover	£54
Reversible boot tray	£81
Rear bumper protection	£100
Front and rear splash guards ³	£100

Comfort

USB charger – 2 front and 2 rear ports	£28
FlexConnect bracket	£20
FlexConnect hook	£37
FlexConnect coat hanger	£41
FlexConnect folding table	£102
FlexConnect iPad Mini holder	£127
FlexConnect iPad holder	£106
FlexConnect iPad Air holder	£106
FlexConnect Samsung Galaxy 10.1 holder	£127
Rear cup holder	£56
Cupholder organisers	£8-10
Smoker's pack	£53
Fragrance diffuser	£24
Fragrance cartridge	£18
Wireless phone charger	£171

Style Total (inc. VAT)

Stainless steel door sill covers (front)	£41
Sport pedal covers – Auto	£44
Sport pedal covers – Manual	£63
Exterior door mirror covers	
- Various colours	£111
Rear-view mirror cover ⁴	
- Various colours	£64
Decal kit with roof and bonnet racing stripes	
- Black	£244
- White	£271
Decal kit with side stripes	
- Black	£222
- White	£256
18-inch diamond-cut bi-colour alloy wheels	
- Set of 4	£1,377
Alloy wheel inserts ⁵ – various colours	
- Set of 4	£32-36
- Each	£20
Alloy wheel centre caps ⁵ – various colours	£15
Chrome valve caps	£10

Transport solutions Total (inc. VAT)

Towing	
Tow bar with removable tow ball and 13-track wiring loom ⁶	£827
Towing harness socket adaptor (13- to 7-pin)	£30

Electric

Mode 2 emergency charging cable (Type G – UK domestic plug)	£584
Mode 3 charging cable	
- 7.4kW	£331
- 11kW	£371
- 22kW	£438
Cable bag	£49
Mode 2 Universal Charger UK kit (22kW)	£1,555
Accessories for Universal Charger	
- Wall bracket	£105
- Bag	£65
- Safety lock	£20
- Adapter Type 2	£318
- Adapter Type 3c	£358
- Adapter (various)	£120

Please note: Prices shown are fully fitted and painted, where applicable and include VAT. Please check with your local Vauxhall Retailer for details. It is advisable to ensure your insurance policy is adequate to cover additional fitted accessories. Prices correct at time of publication.

¹Vehicle must be ordered with spare wheel fixing option (T7Y) in order to accommodate the spare wheel. ²Restrictions apply to the use of child seats, please consult your vehicle user manual or Vauxhall Retailer. ³Side steps and splash guards are not available together.

⁴Only available with anti-dazzle rear-view mirror. ⁵Only for use with 18-inch diamond-cut alloy wheels. ⁶Available on petrol and diesel models only.

Company Car Driver and Fleet Information

Benefit in kind company car taxation*

The car benefit charge will be the car's list price (including VAT, options and accessories fitted, delivery to Retailer and number plates, but excluding Vehicle Excise Duty and new vehicle first registration fee) multiplied by the percentage charge for the CO₂ emissions band in which the car falls (see table opposite). Multiply this figure by your personal income tax rate (20%** for Basic Rate, 40%** for Higher Rate) to calculate your annual benefit in kind tax liability.

Generic example:

ELECTRIC vehicle: 0g/km CO₂

On-the-road RRP	£27,305.00
Deduct: Vehicle Excise Duty	£0.00
New vehicle first registration fee	-£55.00
Effective list price	£27,250.00
Add: Optional two-coat metallic paint	£600.00
List price for tax purposes (P11D value)	£27,850.00
Car benefit charge 2022-23 tax year (2%)	£557.00
Benefit in kind tax liability	
Basic Rate (20%) tax payer	£111.40
Higher Rate (40%) tax payer	£222.80

*Please note this Price Guide provides taxation information as a guide only. Vauxhall does not provide taxation guidance. Drivers should always take professional advice on their own tax position.
**Excludes residents of Scotland.

BiK for Scottish Residents

Effective 6 April 2018 the Scottish Government have introduced their own BiK taxation structure. This only applies to Company Car Drivers that are Scottish taxpayers. HMRC will determine whether or not an individual is a Scottish taxpayer based on where their main place of residence is.

The BiK rates for Scotland are:

- Over £12,570 - £14,732 Starter Rate 19%
- Over £14,732 - £25,688 Basic Rate 20%
- Over £25,688 - £43,662 Intermediate Rate 21%
- Over £43,662 - £150,000 Higher Rate 41%
- Above £150,000 Top Rate 46%

CO ₂ emissions (g/km)	Percentage of cars price to be taxed 2022-23 tax year
Up to 50	14%
51 - 54	15%
55 - 59	16%
60 - 64	17%
65 - 69	18%
70 - 74	19%
75 - 79	20%
80 - 84	21%
85 - 89	22%
90 - 94	23%
95 - 99	24%
100 - 104	25%
105 - 109	26%
110 - 114	27%
115 - 119	28%
120 - 124	29%
125 - 129	30%
130 - 134	31%
135 - 139	32%
140 - 144	33%
145 - 149	34%
150 - 154	35%
155 - 159	36%
160 - 164	37%
165 - 169	37%
170+	37%

CO ₂ emissions (g/km)	Electric range (miles)	Percentage of cars price to be taxed 2022-23 tax year
0	-	2%
1 - 50	130+	2%
1 - 50	70 - 129	5%
1 - 50	40 - 69	8%
1 - 50	30 - 39	12%
1 - 50	<30	14%

To calculate your own personal liability, search: **Vauxhall BiK**, or click the link below:
[Vauxhall BiK Tool](#)

Fleet Toolbox

Discover the facts in our online Toolbox for both Company Car Drivers and Fleet Decision Makers. The Fleet Toolbox has a host of useful calculators, comparators, interactive listings and information.

Search Vauxhall Fleet Tools or click the link below:
[Vauxhall Fleet Tool Box](#)

Contact Vauxhall Fleet

Please contact one of our dedicated sales teams who will be happy to help with your particular enquiry.

Company Car Drivers

Call: 0345 111 2020

Email: company-car@vauxhallinfo.co.uk

Telephone lines are open

- Monday to Friday 8:00am-9:00pm

- Saturday and Sunday 9:00am-6:00pm

Fleet Decision Makers

Depending on the size of your fleet of vehicles, we have a dedicated team to handle your enquiries. The lines are open Monday to Friday excluding Bank Holidays.

1-24 vehicles

Call: 0845 076 2254 (8:30am-5:00pm)

25+ vehicles

Call: 0330 587 8222 (8:30am-5:00pm)

Email: vauxhallfleet@vauxhall.co.uk

Special Vehicles (Police, Fire and Ambulance)

Call: 01582 409999 (8:30am-5:00pm)

Email: vauxhallspecialvehicles@vauxhall.co.uk

For more information visit vauxhall.co.uk/fleet

Further Information

On-the-road prices

To eliminate uncertainty about hidden costs when buying a new car, Vauxhall publishes on-the-road recommended retail prices (RRP) and these are shown in the pricing tables within this price guide. These prices include VAT, number plates and delivery to Retailer of £700.00 (including £116.67 VAT), 12 months' Government Vehicle Excise Duty (see opposite for details) and the DVLA new vehicle first registration fee of £55.00.*

Please note: The on-the-road recommended retail price (RRP) does not include fuel supplied by the Retailer, motor insurance or any other goods or services supplied by agreement between the Retailer and the customer.

Price protection

Order a new Vauxhall for build in the current model year (as confirmed by your Retailer) for delivery no more than three months in advance and the price you are quoted is the price you pay. This is irrespective of any subsequent price rises between placing your order and delivery of your new car, but you must take delivery as soon as the car is available.

Please note: Price protection does not apply to Mokka-e/Corsa-e/Grandland X hybrid models. Vauxhall Motors Limited is not liable for price adjustments caused by Government changes in the rate of VAT (currently 20%), Vehicle Excise Duty, DVLA new vehicle first registration fee or by any other applicable legislation or regulations.

In the event of an accident

Vauxhall Accident Management helps keep you mobile following an accident. Benefits include vehicle recovery, Vauxhall-approved repairs and contacting your insurer. For more details, visit vauxhall.co.uk/AccidentManagement

Free2Move Lease

Whether you're a big company or a small business looking for vehicle financing, Free2Move Lease, our business finance specialists, can deliver exactly what you need.

Free2Move Lease is one of the UK's largest leasing companies and is also a member of the British Vehicle Rental and Leasing Association (BVRLA).

With over 60,000 vehicles in the Free2Move Lease portfolio, Free2Move Lease is able to offer competitive vehicle solutions. In addition, Free2Move Lease also offer innovative connected management of servicing and maintenance.

For further information, please contact your local Vauxhall Retailer or visit vauxhall.co.uk/offers-finance/business-leasing.html

Vehicle Excise Duty

The amount of Vehicle Excise Duty (road fund licence) payable on new cars varies depending on the level of carbon dioxide (CO₂) emissions produced by the vehicle. CO₂ emissions are measured in grams per kilometre (g/km) travelled and divided into 13 charging bands shown in the table opposite.

A 'first year rate' of Vehicle Excise Duty is payable on all new cars and in subsequent years the amount payable reverts to the 'standard rate'. From 1 April 2017 the breakpoints for each of these bands have been revised. Also, for vehicles with a list price over £40,000, including factory-fitted options, an additional £335 is payable for the first five years of standard rate payments.

Vehicle Excise Duty*

Band	CO ₂ emissions in grams per kilometre	First year rate Petrol/Diesel	Standard rate Petrol/Diesel	Standard rate Electric
A	0	£0	£0	£0
B	1 – 50	£10	£165	–
C	51 – 75	£25	£165	–
D	76 – 90	£120	£165	–
E	91 – 100	£150	£165	–
F	101 – 110	£170	£165	–
G	111 – 130	£190	£165	–
H	131 – 150	£230	£165	–
I	151 – 170	£585	£165	–
J	171 – 190	£945	£165	–
K	191 – 225	£1,420	£165	–
L	226 – 255	£2,015	£165	–
M	Over 255	£2,365	£165	–

*Correct at time of issue.

Further Information

Customer Care Commitment

For added peace of mind, Vauxhall has an innovative Customer Care Commitment that offers the following:

- Three-year vehicle warranty consisting of a one-year/unlimited mileage manufacturer's warranty and a second and third year manufacturer's warranty with a 60,000 miles limitation
- Vauxhall Assistance for 12 months from first registration
- Six years' body panel anti-perforation warranty

Please note: Warranty is only available on vehicles sourced from Vauxhall Motors Limited. Terms and conditions apply – please see your Vauxhall Retailer for details.

Vauxhall Assistance

Vauxhall Assistance is provided automatically with every new Vauxhall for 12 months from first registration and covers everything from accident assistance, roadside recovery and 'at home' service to flat tyres. For even more peace of mind, on Mokka-e models the cover is extended* to 8 years or 100,000 miles, whichever comes first. Even more reason for you to stay calm and let us take care of everything should the need arise. With Vauxhall Assistance help is literally just a free** phone call away, 24 hours a day, 365 days a year!

Protecting the environment

Vauxhall's commitment to the environment is demonstrated by our products' many environmental awards. For even more information on Vauxhall's efforts to achieve an environmentally sustainable future, and how to dispose of your end-of-life vehicle, see vauxhall.co.uk/recycling

Vauxhall Care

This all-inclusive service package is available on Vauxhalls under 10 months old (from date of first registration).

This package offers complete peace of mind for the first 3 years of your Vauxhall's life with fixed monthly payments for the plan duration.

- **3 years' Vauxhall servicing** – covers first, second and third annual services. Including a brake-fluid change in the second service
- **2 years' Vauxhall Roadside Assistance** – first year from us
- **First years' MOT[†]** – free of charge by your local Vauxhall Retailer

For full terms and conditions and to sign up, visit: vauxhall.co.uk/vauxhallcare

Vauxhall Service Club

Vauxhall Service Club is available for all Vauxhall owners, and it's free to join. Members benefit from the following:

- 15% off Vauxhall Approved Accessories
- Vauxhall's aged 2-3 Years = 15% off parts and labour
- Vauxhall's aged over 3 Years = 25% off parts and labour
- Half price MOT's (NI excluded)
- Free pre-MOT test inspection (NI only)
- Fixed price AdBlue[®] Refills
 - Car = £14.99
 - Van = £24.99
- Access to the Vauxhall Accident Management Programme
- Online service booking available 24/7 with servicing appointments available within 3 days – [Book Online](#)
- Collection and delivery/onward mobility options
- Complimentary 'Wash and Vac' with all routine services^{††}
- Vauxhall trained technicians
- Genuine Vauxhall parts
- Minimum 12 months warranty on parts and labour
- Regular newsletters with exclusive offers, discounts and competitions

Terms and conditions apply. To join visit: vauxhall.co.uk/serviceclub

Vauxhall Insurance with added reassurance

Comprehensive cover – Summary of benefits

- Competitive premiums
- Repairs by a Vauxhall-trained technician
- Genuine Vauxhall parts, guaranteed for five years when we repair your car within our Approved Repairer Network
- Free courtesy car as standard when using an Approved Repairer[‡]
- 24 hour claims helpline
- Personal Accident benefit
- Cover for audio equipment
- Windscreen cover

Call for a quote on 0330 678 1130^{‡‡}

For more product information

For further information on the Vauxhall range or location of your nearest Vauxhall Retailer please call 0345 600 1500. Alternatively, details can be found on our website at vauxhall.co.uk

For more information call **0345 600 1500**

For Fleet enquiries call **0330 587 8222**

Discover the full Vauxhall range at **[vauxhall.co.uk](https://www.vauxhall.co.uk)**

Join us online

The invoice price, including delivery to Retailer, factory-fitted options, accessories fitted by the Retailer and number plates, is subject to VAT. Some feature descriptions in this guide may refer to, and some illustrations may show, optional equipment not included in the standard delivery. The information contained in this guide was accurate at the time of publication. We reserve the right to make changes in design and equipment. Please note that Vauxhall Retailers are not the agents of Vauxhall Motors Limited and are not authorised to bind Vauxhall Motors Limited by any specific or implied undertaking or representation. It is advisable to ensure that your motor insurance policy provides adequate cover for additional fitted options and accessories. The colours in this guide are only approximate actual colours. Illustrated optional equipment is available at extra charge. Availability, technical features and equipment provided on our vehicles can vary by model. For precise information on the equipment provided on our vehicles, please contact your local Vauxhall Retailer.

VAUXHALL

Price and Specification Guide
6 April 2022 | Model Year 2022C



Mokka

Contents

To find the information you want use the links below to navigate around the guide:

[Choose Your Trim Level](#)

[Range Highlights](#)

[Models](#)

[Prices](#)

[Features/Options](#)

[Infotainment](#)

[Interior Style and Comfort](#)

[Exterior Colours](#)

[Wheels and Tyres](#)

[Engines and Technical Data](#)

[Performance, Economy and Emissions](#)

[Specifications](#)

[Dimensions and Capacities](#)

[Accessories](#)

[Company Car Information](#)

[Further Information](#)

Choose Your Trim Level

SE Edition

First in the line-up is the wonderfully well-equipped SE Edition.

Mokka-e SE Premium

Mokka-e's entry level trim which is highly equipped as standard.



SRI Premium

This sporty number in the range comes with stylish red accents and is loaded with even more tech.

Mokka-e SRI Premium

Stylish, sporty and 100% electric in more ways than one.



Elite Edition

Both Elite models come with sat nav as standard, with Elite Premium giving you even more styling and technology features.

Mokka-e Elite Premium

e-mobility with more than a hint of style and technology thrown in.



Ultimate

All you could ask for; our Ultimate model has it all.

Mokka-e Ultimate

All you could ask for and all-electric; the Ultimate model is top-of-the range.



Mokka Range Highlights

SE Edition

Standard features include:

- Multimedia infotainment system
 - 7-inch colour touchscreen
 - DAB digital radio
 - Bluetooth®
 - Front USB connection
- Six speakers
- 7-inch digital instrument cluster
- 16-inch silver alloy wheels
- Body coloured front/rear skid plates
- Black painted rear spoiler
- Chrome-effect upper window moulding
- Air conditioning
- Driver drowsiness alert
- Forward collision alert (low speed)
- Automatic emergency city braking
- Speed sign recognition
- Cruise control with speed limiter
- Lane departure warning with lane keep assist
- Flat bottomed leather-covered steering wheel
- Steering column adjustable for reach and rake
- Steering wheel mounted audio controls
- Tyre pressure monitoring system
- Remote control central locking
- Electrically adjustable/heated door mirrors
- LED headlights and tail lights
- LED daytime running lights
- Six airbags
- Hill start assist

SRI Premium

Features over SE Edition models:

- Multimedia Navi Pro infotainment system
 - 10-inch colour touchscreen
- 12-inch digital instrument cluster
- 18-inch bi-colour alloy wheels with red accents
- Black roof
- Red upper window moulding
- Black Griffin logo and vizor frame
- Black front/rear skid plates
- Black headliner
- Dark-tinted rear windows
- Front centre armrest with storage
- 2 rear USB connections
- Forward collision alert (all speed)
- Adaptive cruise control
- Lane positioning assistant*
- Heated front seats
- Electronic climate control
- LED front fog lights
- Alloy sports pedals
- Storage pockets on front seat backs
- Panoramic rear-view camera
- Sports switch with engine sound enhancement
- Side blind spot alert and flank guard
- Front and rear parking distance sensors
- Remote control ultrasonic security alarm system
- Keyless entry and start
- Heated steering wheel
- Electrically foldable door mirrors
- Sight and Light Pack

Elite Edition

Features over SE Edition models:

- Multimedia Navi infotainment system
 - Satellite navigation
 - 2 rear USB connections
- 17-inch bi-colour alloy wheels
- Black roof
- Chrome-effect front/rear skid plates
- Forward collision alert (all speed)
- Adaptive cruise control
- Lane positioning assistant (Automatic transmission only)
- Heated front seats
- Heated steering wheel
- Electronic climate control
- LED front fog lights
- Rear parking distance sensors
- Storage pockets on front seat backs
- Panoramic rear-view camera
- Front centre armrest with storage
- Sight and Light Pack

Elite Premium

Features over Elite Edition models:

- Multimedia Navi Pro system
 - 10-inch colour touchscreen
- 12-inch digital instrument cluster
- Vauxhall Connect
- Side blind spot alert and flank guard
- Front and rear parking distance sensors
- Remote control ultrasonic security alarm system
- Keyless entry and start
- Electrically foldable door mirrors

Ultimate

Features over Elite Edition models:

- Multimedia Navi Pro infotainment system
 - 10-inch colour touchscreen
- 12-inch digital instrument cluster
- Vauxhall Connect
- 18-inch bi-colour alloy wheels
- Black headliner
- Dark-tinted rear windows
- Side blind spot alert and flank guard
- Front and rear parking distance sensors
- Remote control security alarm system
- Keyless entry and start
- IntelliLux LED® Matrix headlights with advanced forward lighting
- Automatic headlight levelling system
- Alloy sports pedals
- Sports switch with engine sound enhancement
- Electrically foldable door mirrors
- Leather seat trim
- Massage functionality for driver's seat
- Advanced park assist

*Replaces lane departure warning with lane keep assist. Automatic transmission only.

Mokka-e Range Highlights

SE Premium

Standard features include:

- Multimedia Navi infotainment system
 - Satellite navigation
 - 7-inch colour touchscreen
 - DAB digital radio
 - Bluetooth® audio streaming
 - Bluetooth® mobile phone portal
 - Apple CarPlay/Android Auto™
 - Front USB connection
- Six speakers
- Vauxhall Connect
- 7-inch digital instrument cluster
- 16-inch silver alloy wheels
- Chrome-effect upper window moulding
- Driver drowsiness alert
- Forward collision alert (all speed)
- Lane positioning assistant
- Speed sign recognition
- Automatic emergency city braking
- Adaptive cruise control
- Rear parking distance sensors
- Panoramic rear-view camera
- Electrically/adjustable/heated door mirrors
- Rain-sensitive windscreen wipers
- Automatic anti-dazzle rear-view mirror
- Automatic lighting control with tunnel detection
- Remote control ultrasonic security alarm system
- Flat bottomed leather-covered steering wheel
- Electronic climate control
- Keyless start
- LED headlights and tail lights

SRI Premium

Features over SE Premium models:

- Multimedia Navi Pro infotainment system
 - 10-inch colour touchscreen
 - 2 rear USB connections
- 12-inch digital instrument cluster
- 18-inch bi-colour alloy wheels with red accents
- Black roof
- Red upper window moulding
- Black Griffin logo and vizor frame
- Black front/rear skid plates
- Black headliner
- Dark-tinted rear windows
- Front centre armrest with storage
- Side blind spot alert and flank guard
- Front and rear parking distance sensors
- Storage pockets on front seat backs
- Keyless entry and start
- Heated steering wheel
- Heated front seats
- LED front fog lights
- Alloy sports pedals
- Electrically foldable door mirrors

Elite Premium

Features over SE Premium models:

- Multimedia Navi Pro infotainment system
 - 10-inch colour touchscreen
 - 2 rear USB connections
- 12-inch digital instrument cluster
- 17-inch bi-colour alloy wheels
- Black roof
- Chrome-effect front/rear skid plates
- Front centre armrest with storage
- Side blind spot alert and flank guard
- Front and rear parking distance sensors
- Storage pockets on front seat backs
- Keyless entry and start
- Heated steering wheel
- Heated front seats
- LED front fog lights
- Electrically foldable door mirrors

Ultimate

Features over Elite Premium models:

- 18-inch bi-colour alloy wheels
- Black headliner
- Advanced park assist
- IntelliLux LED® Matrix headlights with advanced forward lighting
- Automatic headlight levelling system
- Alloy sports pedals
- Dark-tinted rear windows
- Leather seat trim
- Massage functionality for driver's seat

Mokka SE Edition



VX_MOK_32599

SE Edition OTR from £22,265

Infotainment:

- Multimedia system
 - 7-inch colour touchscreen
 - DAB digital radio
 - Bluetooth® audio streaming
 - Bluetooth® mobile phone portal
 - Apple CarPlay/Android Auto™
 - Front USB connection
- Six speakers

Interior convenience/styling:

- 7-inch digital instrument cluster
- Air conditioning
- Flat bottomed leather-covered steering wheel
- Steering column adjustable for reach and rake
- Steering wheel mounted audio controls
- Storage pockets on front seat backs

Exterior convenience/styling:

- 16-inch silver alloy wheels
- Body coloured front/rear skid plates
- Chrome-effect upper window moulding
- Electrically adjustable/heated door mirrors
- LED headlights
- LED daytime running lights
- High beam assist
- LED tail lights

Safety/security:

- Driver drowsiness alert
- Forward collision alert (low speed)
- Automatic emergency city braking
- Cruise control with speed limiter
- Lane departure warning with lane keep assist
- Tyre pressure monitoring system
- Remote control central locking
- Speed sign recognition
- Electronic Stability Programme (ESP)
- Anti-lock Braking System (ABS)
- Six airbags
- Hill start assist

Mokka SRi Premium



VX_MOK_32597

SRi Premium OTR from £26,140

Infotainment:

- Multimedia Navi Pro infotainment system
 - Satellite navigation
 - 10-inch colour touchscreen
 - DAB digital radio
 - Bluetooth® audio streaming
 - Bluetooth® mobile phone portal
 - Apple CarPlay/Android Auto™
 - Front USB connection
 - 2 rear USB connections
- Six speakers

Interior convenience/styling:

- 12-inch digital instrument cluster
- Black headliner
- Flat bottomed leather-covered steering wheel
- Heated steering wheel
- Automatic anti-dazzle rear-view mirror
- Alloy sports pedals
- Heated front seats
- Electronic climate control
- Front centre armrest with storage
- Storage pockets on front seat backs
- Sports switch with engine sound enhancement
- Steering column adjustable for reach and rake
- Steering wheel mounted audio controls

Exterior convenience/styling:

- 18-inch bi-colour alloy wheels with red accents
- Black roof
- Red upper window moulding
- Black Griffin logo and vizor frame
- Black front/rear skid plates
- Dark-tinted rear windows

- Electrically adjustable/heated/foldable door mirrors
- Rain-sensitive windscreen wipers
- LED headlights
- LED front fog lights
- LED daytime running lights
- High beam assist
- LED tail lights
- Automatic lighting control with tunnel detection

Safety/security:

- Active Drive Assist Plus
 - Driver drowsiness alert
 - Forward collision alert (all speed)
 - Automatic emergency city braking
 - Cruise control with speed limiter
 - Lane departure warning with lane keep assist (Manual transmission only)
 - Lane positioning assistant (Automatic transmission only)
- Tyre pressure monitoring system
- Remote control central locking
- Speed sign recognition
- Adaptive cruise control
- Panoramic rear-view camera
- Six airbags
- Hill start assist
- Side blind spot alert and flank guard
- Front and rear parking distance sensors
- Remote control ultrasonic security alarm system
- Keyless entry and start

This vehicle is covered by our Price Protection Guarantee. See 'Further Information' page for details.

Mokka Elite Edition



VX_MOK_32601

Elite Edition OTR from £24,735

Infotainment:

- Multimedia Navi system
 - Satellite navigation
 - 7-inch colour touchscreen
 - DAB digital radio
 - Bluetooth® audio streaming
 - Bluetooth® mobile phone portal
 - Apple CarPlay/Android Auto™
 - Front USB connection
 - 2 rear USB connections
- Six speakers

Interior convenience/styling:

- 7-inch digital instrument cluster
- Flat bottomed leather-covered steering wheel
- Automatic anti-dazzle rear-view mirror
- Heated front seats
- Heated steering wheel
- Electronic climate control
- Storage pockets on front seat backs
- Front centre armrest with storage
- Steering column adjustable for reach and rake
- Steering wheel mounted audio controls

Exterior convenience/styling:

- 17-inch bi-colour alloy wheels
- Black painted rear spoiler
- Black roof
- Chrome-effect upper window moulding
- Matt chrome-effect front/rear skid plates
- Electrically/adjustable/heated door mirrors
- Rain-sensitive windscreen wipers
- LED headlights
- LED daytime running lights
- High beam assist
- LED tail lights

- LED front fog lights
- Automatic lighting control with tunnel detection

Safety/security:

- Active Drive Assist Plus
 - Driver drowsiness alert
 - Forward collision alert (all speed)
 - Automatic emergency city braking
 - Cruise control with speed limiter
 - Lane departure warning with lane keep assist (Manual transmission only)
 - Lane positioning assistant (Automatic transmission only)
- Tyre pressure monitoring system
- Remote control central locking
- Speed sign recognition
- Adaptive cruise control
- Rear parking distance sensors
- Panoramic rear-view camera
- Six airbags
- Hill start assist

Elite Premium

OTR from
£25,785

Features over Elite Nav

- Multimedia Navi Pro system
 - 10-inch colour touchscreen
- 12-inch digital instrument cluster
- Vauxhall Connect
- Side blind spot alert and flank guard
- Front and rear parking distance sensors
- Remote control ultrasonic security alarm system
- Keyless entry and start
- Electrically foldable door mirrors

This vehicle is covered by our Price Protection Guarantee. See 'Further Information' page for details.

Mokka Ultimate



VX_MOK_32603

Ultimate OTR from £30,175

Infotainment:

- Multimedia Navi Pro system
 - Satellite navigation
 - 10-inch colour touchscreen
 - DAB digital radio
 - Bluetooth® audio streaming
 - Bluetooth® mobile phone portal
 - Apple CarPlay/Android Auto™
 - Front USB connection
 - 2 rear USB connections
- Six speakers
- Vauxhall Connect

Interior convenience/styling:

- Leather seat trim
- Massage functionality for driver's seat
- 12-inch digital instrument cluster
- Black headliner
- Flat bottomed leather-covered steering wheel
- Automatic anti-dazzle rear-view mirror
- Heated front seats
- Heated steering wheel
- Electronic climate control
- Alloy sports pedals
- Storage pockets on front seat backs
- Front centre armrest with storage
- Sports switch with engine sound enhancement
- Steering column adjustable for reach and rake
- Steering wheel mounted audio controls

Exterior convenience/styling:

- 18-inch bi-colour alloy wheels
- Black roof
- Chrome-effect upper window moulding
- Chrome-effect front/rear skid plates

- Dark-tinted rear windows
- Electrically foldable/adjustable/heated door mirrors
- Rain-sensitive windscreen wipers
- IntelliLux LED® Matrix headlights with advanced forward lighting
- LED daytime running lights
- High beam assist
- LED tail lights
- LED front fog lights
- Automatic headlight levelling system
- Automatic lighting control with tunnel detection

Safety/security:

- Active Drive Assist Plus
 - Driver drowsiness alert
 - Forward collision alert (all speed)
 - Automatic emergency city braking
 - Cruise control with speed limiter
 - Lane departure warning with lane keep assist (Manual transmission only)
 - Lane positioning assistant (Automatic transmission only)
 - Vauxhall Connect with e-Call
- Tyre pressure monitoring system
- Remote control ultrasonic security alarm system
- Speed sign recognition
- Adaptive cruise control
- Side blind spot alert and flank guard
- Front and rear parking distance sensors
- Panoramic rear-view camera
- Keyless entry and start
- Six airbags
- Hill start assist
- Advanced park assist

This vehicle is covered by our Price Protection Guarantee. See 'Further Information' page for details.

Mokka-e SE Premium



VX_MOK_32600

SE Premium

OTR £29,365*

Infotainment:

- Multimedia Navi system
 - Satellite navigation
 - 7-inch colour touchscreen
 - DAB digital radio
 - Bluetooth® audio streaming
 - Bluetooth® mobile phone portal
 - Apple CarPlay/Android Auto™
 - Front USB connection
- Six speakers
- Vauxhall Connect
- 7-inch digital instrument cluster

Interior convenience/styling:

- Automatic anti-dazzle rear-view mirror
- Flat bottomed leather-covered steering wheel
- Electronic climate control
- Steering column adjustable for reach/rake

Exterior convenience/styling:

- 16-inch silver alloy wheels
- Chrome-effect upper window moulding
- Electrically/adjustable/heated door mirrors
- Rain-sensitive windscreen wipers
- LED headlights
- LED daytime running lights
- High beam assist
- LED tail lights
- Automatic lighting control with tunnel detection

Safety/security:

- Active driver Assist Plus
 - Driver drowsiness alert
 - Forward Collision alert (all speed)
 - Automatic emergency city braking
 - Adaptive cruise control
 - Lane positioning assistant
- Rear parking distance sensors
- Panoramic rear-view camera
- Speed sign recognition
- Remote control ultrasonic security alarm system
- Keyless start
- Tyre pressure monitoring system
- Hill start assist

*Price shown is after allowing for PiCG (Plug-in Car Grant).

Mokka-e SRi Premium



VX_MOK_32598

SRi Premium OTR £30,435*

Infotainment:

- Multimedia Navi Pro system
 - Satellite navigation
 - 10-inch colour touchscreen
 - DAB digital radio
 - Bluetooth® audio streaming
 - Bluetooth® mobile phone portal
 - Apple CarPlay/Android Auto™
 - Front USB connection
 - 2 rear USB connections
- Six speakers
- Vauxhall Connect
- 12-inch digital instrument cluster

Interior convenience/styling:

- Black headliner
- Automatic anti-dazzle rear-view mirror
- Flat bottomed leather-covered steering wheel
- Electronic climate control
- Heated steering wheel
- Heated front seats
- Alloy sports pedals
- Front centre armrest with storage
- Storage pockets on front seat backs
- Steering column adjustable for reach/rake

Exterior convenience/styling:

- 18-inch bi-colour alloy wheels with red accents
- Black roof
- Red upper window moulding
- Black Griffin logo and vizer frame
- Black front/rear skid plates
- Dark-tinted rear windows
- Electrically foldable/adjustable/heated door mirrors
- Rain-sensitive windscreen wipers
- LED headlights
- LED daytime running lights
- High beam assist
- LED tail lights
- LED front fog lights
- Automatic lighting control with tunnel detection

Safety/security:

- Active Driver Assist Plus
 - Driver drowsiness alert
 - Forward collision alert (all speed)
 - Automatic emergency city braking
 - Adaptive cruise control
 - Lane positioning assistant
 - Vauxhall Connect with e-call
- Front and rear parking distance sensors
- Panoramic rear-view camera
- Speed sign recognition
- Remote control ultrasonic security alarm system
- Keyless entry and start
- Tyre pressure monitoring system
- Side blind spot alert and flank guard
- Hill start assist

*Price shown is after allowing for PiCG (Plug-in Car Grant).

Mokka-e Elite Premium



VX_MOK_32602

Elite Premium OTR £30,080*

Infotainment:

- Multimedia Navi Pro system
 - Satellite navigation
 - 10-inch colour touchscreen
 - DAB digital radio
 - Bluetooth® audio streaming
 - Bluetooth® mobile phone portal
 - Apple CarPlay/Android Auto™
 - Front USB connection
 - 2 rear USB connections
- Six speakers
- Vauxhall Connect
- 12-inch digital instrument cluster

Interior convenience/styling:

- Automatic anti-dazzle rear-view mirror
- Flat bottomed leather-covered steering wheel
- Electronic climate control
- Steering column adjustable for reach/rake
- Heated steering wheel
- Heated front seats
- Alloy sports pedals
- Front centre armrest with storage
- Storage pockets on front seat backs

Exterior convenience/styling:

- 17-inch bi-colour alloy wheels
- Black roof
- Chrome-effect upper window moulding
- Chrome-effect front/rear skid plates
- Electrically foldable/adjustable/heated door mirrors
- Rain-sensitive windscreen wipers
- LED headlights
- LED daytime running lights
- High beam assist
- LED tail lights
- LED front fog lights
- Automatic lighting control with tunnel detection

Safety/security:

- Active Driver Assist Plus
 - Driver drowsiness alert
 - Forward collision alert (all speed)
 - Automatic emergency city braking
 - Adaptive cruise control
 - Lane positioning assistant
 - Vauxhall Connect with e-Call
- Front and rear parking distance sensors
- Panoramic rear-view camera
- Speed sign recognition
- Remote control ultrasonic security alarm system
- Keyless entry and start
- Tyre pressure monitoring system
- Side blind spot alert and flank guard
- Hill start assist

*Price shown is after allowing for PiCG (Plug-in Car Grant).

Mokka-e Ultimate



VX_MOK_32604

Ultimate

OTR £30,495*

Infotainment:

- Multimedia Navi Pro system
 - Satellite navigation
 - 10-inch colour touchscreen
 - DAB digital radio
 - Bluetooth® audio streaming
 - Bluetooth® mobile phone portal
 - Apple CarPlay/Android Auto™
 - Front USB connection
 - 2 rear USB connections
- Six speakers
- Vauxhall Connect
- 12-inch digital instrument cluster

Interior convenience/styling:

- Black headliner
- Automatic anti-dazzle rear-view mirror
- Flat bottomed leather-covered steering wheel
- Electronic climate control
- Steering column adjustable for reach/rake
- Heated steering wheel
- Heated front seats
- Alloy sports pedals
- Front centre armrest with storage
- Massage functionality for driver's seat
- Storage pockets on front seat backs
- Leather seat trim

Exterior convenience/styling:

- 18-inch bi-colour alloy wheels
- Black roof
- Chrome-effect upper window moulding
- Chrome-effect front/rear skid plates
- Dark-tinted rear windows
- Electrically foldable/adjustable/heated door mirrors
- Rain-sensitive windscreen wipers
- IntelliLux LED® Matrix headlights with advanced forward lighting
- LED daytime running lights
- High beam assist
- LED tail lights
- LED front fog lights
- Automatic headlight levelling system
- Automatic lighting control with tunnel detection

Safety/security:

- Active Driver Assist Plus
 - Driver drowsiness alert
 - Forward collision alert (all speed)
 - Automatic emergency city braking
 - Adaptive cruise control
 - Lane positioning assistant
 - Vauxhall Connect with e-call
- Front and rear parking distance sensors
- Panoramic rear-view camera
- Speed sign recognition
- Remote control ultrasonic security alarm system
- Keyless entry and start
- Tyre pressure monitoring system
- Side blind spot alert and flank guard
- Advanced park assist
- Hill start assist

*Price shown is after allowing for PiCG (Plug-in Car Grant).

Mokka Prices

	Pack Code	Fuel Type	Price (£)	VAT (£)	Total (£)	On-the-road RRP (£)	Financial Year 2022/23 BiK 20% (£)	WLTP Combined CO ₂ (g/km)* - pack code	Insurance groups
SE Edition									
1.2 (100PS) Turbo	MC76 EU61	Petrol	17,766.67	3,553.33	21,320.00	22,265.00	110.08	125	13E
1.5 (110PS) Turbo D	MC76 HZ61	Diesel	19,266.67	3,853.33	23,120.00	24,065.00	107.18	114	14E
SRI Premium									
1.2 (100PS) Turbo	MS76 EU61	Petrol	20,995.83	4,199.17	25,195.00	26,140.00	129.47	127	14E
1.2 (130PS) Turbo	MS76 EP61	Petrol	21,995.83	4,399.17	26,395.00	27,340.00	135.47	126	18E
1.2 (130PS) Turbo auto	MS76 EF81	Petrol	23,329.17	4,665.83	27,995.00	28,980.00	153.03	137	18E
1.5 (110PS) Turbo D	MS76 HZ61	Diesel	22,495.83	4,499.17	26,995.00	27,940.00	129.23	116	15E
Elite Edition									
1.2 (100PS) Turbo	ME76 EU61	Petrol	19,825.00	3,965.00	23,790.00	24,735.00	122.43	127	14E
1.2 (130PS) Turbo	ME76 EP61	Petrol	20,825.00	4,165.00	24,990.00	25,935.00	128.43	126	20D
1.2 (130PS) Turbo auto	ME76 EF81	Petrol	22,158.33	4,431.67	26,590.00	27,575.00	145.53	137	20D
1.5 (110PS) Turbo D	ME76 HZ61	Diesel	21,325.00	4,265.00	25,590.00	26,535.00	122.68	116	15E
Elite Premium									
1.2 (100PS) Turbo	MJ76 EU61	Petrol	20,700.00	4,140.00	24,840.00	25,785.00	127.68	127	14E
1.2 (130PS) Turbo	MJ76 EP61	Petrol	21,700.00	4,340.00	26,040.00	26,985.00	133.68	126	18E
1.2 (130PS) Turbo auto	MJ76 EF81	Petrol	23,033.33	4,606.67	27,640.00	28,625.00	151.13	137	18E
1.5 (110PS) Turbo D	MJ76 HZ61	Diesel	22,200.00	4,440.00	26,640.00	27,585.00	127.58	116	15E
Ultimate									
1.2 (130PS) Turbo auto	MU76 EF81	Petrol	25,191.67	5,038.33	30,230.00	31,215.00	164.95	137	19E
1.5 (110PS) Turbo D	MU76 HZ61	Diesel	24,358.33	4,871.67	29,230.00	30,175.00	139.67	116	16E

Mokka's petrol and diesel engines meet the Real Driving Emissions Step 2 (RDE2) standards.

*Fuel consumption and CO₂ figures are determined according to the WLTP test cycle. CO₂ figures, BiK values and RRP pricing shown above are for a standard vehicle without any additional optional equipment. CO₂ figures are used to calculate Vehicle Excise Duty (VED) for the first registration of the vehicle and BiK. The addition of optional extras could increase the certified CO₂ emission output. This in turn may affect the amount of VED payable upon registration, and, for company car drivers, the P11D value and the amount of Benefit in Kind (BiK) tax payable. Figures shown are for comparison purposes and should only be compared to the fuel consumption and CO₂ values of other cars tested to the same technical standard. The fuel consumption achieved, and CO₂ produced, in real world conditions will depend upon a number of factors including, but not limited to: the accessories fitted (pre and post registration); variations in weather; driving styles and vehicle load. The WLTP (Worldwide Harmonised Light Vehicles Test Procedure) is used to measure fuel consumption and CO₂ figures. Full data relating to WLTP test cycles can be found at: www.vauxhall.co.uk/wltp

Please note: On-the-road recommended retail prices (RRP) include number plates and delivery to Retailer of £700.00 (inc. £116.67 VAT), 12 months' Vehicle Excise Duty and new vehicle first registration fee of £55.00. Excludes fuel and insurance. Company Car Benefit in Kind (BiK) rates are monthly based on the standard paint price. On-the-road prices feature a VED based on preliminary CO₂ information.

Mokka-e Prices

	Pack Code	Price (£)	VAT (£)	Total (£)	On-the-road RRP before PiCG (£)	On-the-road RRP after PiCG (£)	Financial Year 2022/23 BiK 20% (£)	WLTP Combined CO ₂ (g/km) – pack code	Insurance groups
SE Premium 11kW									
Electric Propulsion (136PS) auto	MD76 9CQ1	25,091.67	5,018.33	30,110.00	30,865.00	29,365.00	5.13	0	21E
SRI Premium 11kW									
Electric Propulsion (136PS) auto	MM76 9CQ1	25,983.33	5,196.67	31,180.00	31,935.00	30,435.00	5.30	0	22E
Elite Premium 11kW									
Electric Propulsion (136PS) auto	ML76 9CQ1	25,687.50	5,137.50	30,825.00	31,580.00	30,080.00	5.25	0	22E
Ultimate 11kW									
Electric Propulsion (136PS) auto	MH76 9CQ1	26,033.33	5,206.67	31,240.00	31,995.00	30,495.00	5.32	0	23E

Please note: On-the-road recommended retail prices (RRP) include number plates and delivery to Retailer of £700.00 (inc. £116.67 VAT), 12 months' Vehicle Excise Duty and new vehicle first registration fee of £55.00. Excludes fuel and insurance. Company Car Benefit in Kind (BiK) rates are monthly based on the standard paint price. Price has been calculated using manufacturer estimates and includes a £1,500.00 OZEV grant which has been deducted from the price of the vehicle (OZEV Grant not available in the Isle of Man). Mokka-e is expected to be a qualifying model for this grant subject to acceptance by OZEV. Please check with your Retailer for latest status. The grant is a government incentive and is subject to withdrawal prior to delivery of your vehicle. Retailers may be required to carry out more than one credit check during the course of the order process. You may be required to place a deposit when placing your order with your supplying Retailer. In the event of a price change, deposit refunds will be governed by your supplying Retailer's policy and as such must be discussed with the supplying Retailer.

Mokka-e is not covered by our Price Protection Guarantee. See 'Further Information' page for details.

Safety

Standard Features – The following features are standard across the entire Mokka range.

Airbags

- Driver's airbag
- Front passenger's airbag
- Front seat side-impact airbags
- Full-size curtain airbags

Seating

- Three height adjustable rear seat head restraints

Seatbelts

- Inertia-reel lap and diagonal seatbelts
- Seatbelt unfastened' audible warning and warning light

Braking

- Automatic emergency city braking – The system works automatically in conjunction with forward collision alert, at speeds between 3mph and 53mph, and detects both vehicles and pedestrians. If no avoiding action is taken by the driver, at speeds below 19mph the system automatically slows the vehicle to a full stop with emergency braking of 0.9g. At speeds from 19mph to 53mph it brakes automatically to reduce speed by a maximum of 14mph – to reduce speed even further the driver must brake him/herself

- Anti-lock Braking System (ABS)
- Emergency brake assist – When emergency braking is detected the vehicle automatically applies the maximum possible braking assistance
- Electronic brakeforce distribution – Automatically apportions the optimum braking force to each wheel
- Hill start assist – Briefly maintains rear brake pressure to stop the vehicle rolling back on an incline
- Adaptive brake lights – Automatically warns other road users of heavy braking

Child safety

- Deactivation switch for front passenger's front and side-impact airbags
- ISOFIX child seat mountings incorporating top tether anchor points located on outer rear seats (does not include child seat) – Allows ISOFIX child safety seats to be securely fixed into the car. The ISOFIX mounting system reduces forward movement in an accident and makes the child seat easier to install
- Child-proof locks on rear doors

Stability

- Electronic Stability Programme (ESP) – ESP monitors many different inputs to determine when the car starts to lose traction, it can then immediately respond by varying the brake pressure between up to three wheels and adjust the engine output to help correct the loss of traction and improve stability

Additional ESP features

- Traction control
- Cornering brake control
- Straight line stability control
- Drag torque control – Maintain stability on slippery roads when lifting off the accelerator or changing gear

Tyre pressure

- Tyre pressure monitoring system

Vauxhall driver assistance systems are intended to support the driver within the system-imminent limitations. The driver remains responsible for the driving task at all times.



Hill start assist.



ISOFIX child seat mountings.



Automatic emergency city braking.

Driver Assistance

Standard Features – The following features are standard across the entire Mokka range.
Specific features by model are outlined in the separate tabular information.

Cruise control with speed limiter

With steering wheel mounted controls. Enables you to maintain a constant speed, making it ideal for economical motorway driving.

Front camera system

A range of class-leading driver assistance and safety features are controlled by the front camera system.

Forward collision alert

The system operates automatically from 3mph and gives an audible warning as well as a visual warning when approaching another vehicle too quickly.

Steering

- Speed sensitive electrically assisted power steering
- Reach and rake adjustable steering

Speed sign recognition

Detects and then displays speed limits, reducing uncertainty and the risk of speeding.

- Recognises different speed signs, including temporary speed restrictions
- Displays reminder in the instrument cluster

Driver drowsiness alert

The system monitors driving time and driving behaviour to help prevent accidents caused by tiredness.

Lane departure warning with lane keep assist

If the driver has not actively steered or signalled, the lane departure warning system provides gentle steering correction and warns when the car moves outside of lane markings at speeds above 40mph.

- Warning light in instrument cluster
- Audible warning
- Facia on/off switch

Model Specific Features

							Electric models			
	SE Edition	SRi Premium	Elite Edition	Elite Premium	Ultimate	SE Premium	SRi Premium	Elite Premium	Ultimate	
Driver Assistance										
Forward collision alert (low speed)	●									
Forward collision alert (all speed)		●	●	●	●	●	●	●	●	
Lane positioning assistant (automatics only)		●	●	●	●	●	●	●	●	
Adaptive cruise control		●	●	●	●	●	●	●	●	
Side blind spot alert and flank guard		●		●	●		●	●	●	
Rear parking distance sensors			●			●				
Front and rear parking distance sensors		●		●	●		●	●	●	
Panoramic rear-view camera		●	●	●	●	●	●	●	●	
Advanced park assist					●				●	
Sports switch with engine sound enhancement		●			●					

Convenience

Standard Features – The following features are standard across the entire Mokka range.
Specific features by model are outlined in the separate tabular information.

Interior Convenience

- Front 12-volt electrical accessory socket
- Driver's and front passengers sunvisors incorporating vanity mirrors with covers
- Dipping rear-view mirror
- Reach and rake-adjustable steering
- Steering wheel mounted audio controls
- Front USB connection

Heating and Ventilation

- Air recirculation facility
- Cabin particulate filter – Removes dust, airborne particles and pollen
- Four-speed fan
- Illuminated controls
- Four adjustable facia vents
- Windscreen demist vents
- Side window demist vents

Interior Storage

- Centre console with two cup holders at front and one in rear
- Interior courtesy light
- Front map reading lights
- Luggage compartment lighting
- Door pockets with two-litre capacity

Model Specific Features

							Electric models			
	SE Edition	SRi Premium	Elite Edition	Elite Premium	Ultimate	SE Premium	SRi Premium	Elite Premium	Ultimate	
Interior Convenience and Storage										
Front centre armrest with storage		●	●	●	●		●	●	●	
Automatically dimming anti-dazzle rear-view mirror		●	●	●	●	●	●	●	●	
Storage pockets on front seat backs		●	●	●	●		●	●	●	
2 rear USB connections		●	●	●	●		●	●	●	
Heating and Ventilation										
Air conditioning	●									
Electronic climate control		●	●	●	●	●	●	●	●	
Heated steering wheel		●	●	●	●		●	●	●	
Heated front seats		●	●	●	●		●	●	●	

Exterior Style and Lighting

Standard Features – The following features are standard across the entire Mokka range.
Specific features by model are outlined in the separate tabular information.

Exterior Styling

- Body-colour front and rear bumpers
- Body-colour door handles
- Black door mirror housing
- Integrated black tailgate spoiler

Exterior Lighting

- LED daytime running lights
- LED side repeat indicators
- Lights-on audible warning – When driver's door is opened an audible warning sounds to alert the lights have been left on

- LED tail lights
- Rear fog light
- Reversing light
- Hazard warning lights

Model Specific Features/Option

						Electric models			
	SE Edition	SRi Premium	Elite Edition	Elite Premium	Ultimate	SE Premium	SRi Premium	Elite Premium	Ultimate
Exterior Styling									
Dark-tinted rear windows		●			●		●		●
Black Griffin logo and vizor frame		●					●		
Body coloured front/rear skid plates	●					●			
Black front/rear skid plates		●					●		
Chrome-effect front/rear skid plates			●	●	●			●	●
Exterior Lighting									
LED headlights	●	●	●	●		●	●	●	
IntelliLux Matrix LED® headlights with advanced forward lighting		£700*	£700*	£700*	●		£700*	£700*	●
Automatic lighting control with tunnel detection		●	●	●	●	●	●	●	●
High beam assist	●	●	●	●		●	●	●	
High beam assist with anti-glare					●				●
LED front fog lights		●	●	●	●		●	●	●
Manual headlight levelling system	●	●	●	●		●	●	●	
Automatic headlight levelling system					●				●

*Optional at extra cost including VAT.

Pure Panel – Driver Information

Standard Features – The following features are standard across the entire Mokka range.
Specific features by model are outlined in the separate tabular information.

Digital Display Information

Pure Panel technology makes driving more intuitive, with a flowing design that presents the information you need. With up to a 10-inch infotainment touchscreen and 12-inch digital instrument cluster right in front of you, you can stay focused on the road ahead.

Driver Information

Digital instrumentation

- Digital speedometer and rev counter
- Satellite Navigation display
- Digital fuel gauge with low fuel level warning light
- Digital water temperature gauge with warning light
- Shift-up/down indication light – Indicates when to change gear for optimum fuel economy

Driver information display (centrally located in digital instrument cluster)

- Total mileage
- Service-due indicator
- Oil life
- Tyre pressure monitoring system

Multi-function trip computer (displayed on digital instrument cluster)

- Trip mileage
- Vehicle range based on remaining fuel
- Average speed
- Average fuel economy
- Instantaneous fuel economy
- Driving time

Digital central facia display (format dependent on infotainment unit)

- Audio information
- Digital clock with automatic RDS time adjustment
- Outside air temperature with ice warning function
- Additional features dependent on infotainment unit



Model Specific Features

							Electric models			
	SE Edition	SRi Premium	Elite Edition	Elite Premium	Ultimate	SE Premium	SRi Premium	Elite Premium	Ultimate	
Driver Information										
7-inch digital instrument cluster (centrally located in instrument panel)	●		●			●				
12-inch digital instrument cluster (centrally located in instrument panel)		●		●	●		●	●	●	

Pure Panel – Infotainment

Standard Features

Multimedia with 7-inch touchscreen

Standard on SE Edition

Onboard features:

- 7-inch colour touchscreen
- DAB Digital radio
- RDS with Traffic Programme
- AM/FM stereo radio with 36 station presets
- Six speakers

Media connections:

- USB connection
- Bluetooth® A2DP audio streaming (Advanced Audio Distribution Profile)

Mobile phone portal:

- Bluetooth® connectivity
- Vehicle microphone
- Handsfree calls via steering wheel controls
- Phone book access – Contacts/last calls/missed calls etc. are mirrored on the display and are easily navigated using the touchscreen (features dependent on mobile phone).
- SMS read out and reply

Smartphone interface:

- Apple CarPlay • Android Auto™
- Smartphone projection that allows operations via voice command, touchscreen and buttons to control apps and music playback

Additional features:

- Steering wheel mounted audio controls
- Flexible roof-mounted aerial

Please note that compatibility and certain functions may be different depending on the type of device and operating system you're using with the Multimedia systems. Apple CarPlay is a trademark of Apple Inc. Apple and iPhone are trademarks of Apple Inc., registered in the U.S. and other countries. Android is a trademark of Google Inc, also registered in the U.S. and other countries. *Standard on Elite Premium and Ultimate models and all Mokka-e models only. Services may require a subscription/fee and are subject to mobile network coverage and availability. Standard on Nav models only. Live navigation services are included for 3 years and thereafter are subject to an additional subscription fee.

Multimedia Navi with 7-inch touchscreen

Standard on Elite Edition

Standard on Mokka-e SE Premium models

Features as Multimedia, with the addition of:

- Satellite navigation system
- 2D/3D street level mapping
- European coverage
- Points-of-interest search
- Map updates via USB

Multimedia Navi Pro with 10-inch touchscreen

Standard on SRi Premium, Elite Premium and Ultimate

Standard on Mokka-e SRi Premium, Elite Premium and Ultimate models

Features as Multimedia Navi, with the addition of:

- 10-inch colour touchscreen

Vauxhall Connect*

e-Call and b-Call:

Help when you need it, 24/7, 365 days a year, that's what you get with new Vauxhall Connect. In an emergency or breakdown, you'll be put in touch with a trained advisor, with just the touch of a button.

Live navigation and more:

You can also access live navigation services, receive regular vehicle diagnostic info plus there's a host of remote convenience features available through the MyVauxhall app.

- **Peace of mind:** emergency call, breakdown call and regular vehicle status and information
- **Convenience:** remote functions (e.g. lock/unlock the door)
- **Our additional services for electric vehicles:** trip planning, remote settings or public charging solutions – we keep you going!
- **Smart driving:** enjoy a relaxed ride thanks to live navigation and trip management



Please note, Apple CarPlay screen illustrated on 10-inch colour touchscreen on multimedia Navi Pro audio unit.

Interior Styling and Comfort

SE Edition/SE Premium



Steering wheel:

- Three-spoke design
- Flat bottomed leather-covered steering wheel
- Satin chrome-effect bezel

Facia and door trim:

- Black facia with silver trim inserts
- Instrument panel bar Light Gravel
- Atlantis black trim inserts on front doors
- Chrome-effect interior door handles

Seating:

- Driver's seat (six-way adjustable):
 - Height
 - Reach
 - Backrest
- Front passenger's seat (four-way adjustable)
 - Reach
 - Backrest

Seat trim:

- Jet black fabric seat trim inserts
- Jet black fabric side bolsters

SRi Premium



Steering wheel:

- Three-spoke design
- Flat bottomed leather-covered steering wheel. Heated for SRi Nav Premium
- Satin chrome-effect bezel

Facia and door trim:

- Black facia with red trim inserts
- Instrument panel bar Light Gravel
- Atlantis black trim inserts on front doors
- Chrome-effect interior door handles

Seating:

- Driver's and front passenger's seat (six-way adjustable):
 - Height
 - Reach
 - Backrest
- Heated front seats

Seat trim:

- Minstral and Jet black fabric leather-effect seat trim inserts
- Jet black fabric side bolsters

Interior Styling and Comfort

Elite Edition/Elite Premium



Steering wheel:

- Three-spoke design
- Flat bottomed leather-covered steering wheel
- Satin chrome-effect bezel

Facia and door trim:

- Black facia with silver trim inserts
- Instrument panel bar Light Gravel
- Atlantis black trim inserts on front doors
- Chrome-effect interior door handles

Seating:

- Driver's and front passenger's seat (six-way adjustable):
 - Height
 - Reach
 - Backrest
- Heated front seats

Seat trim:

- Jet black fabric leather-effect seat trim inserts
- Jet black fabric side bolsters

Elite Premium model illustrated.

Ultimate



Steering wheel:

- Three-spoke design
- Heated flat bottomed leather-covered steering wheel
- Satin chrome-effect bezel

Facia and door trim:

- Black facia with silver trim inserts
- Instrument panel bar Polar Silver
- Atlantis black trim inserts on front doors
- Chrome-effect interior door handles

Seating:

- Driver's and front passenger's seat (six-way adjustable):
 - Height
 - Reach
 - Backrest
- Heated front seats
- Driver's massage function

Seat trim:

- Black Sienna perforated leather seat trim inserts

Exterior Colours

Jade White (G2o)*
Brilliant paint



VX_MOK_31264

Quartz Grey (G4i)**
Two-coat metallic paint £600



VX_MOK_31268

Voltaic Blue (G6l)†
Two-coat metallic paint £600



VX_MOK_31265

Diamond Black (G7o)**
Two-coat metallic paint £600



VX_MOK_31267

Mamba Green (GGl)†
Two-coat premium metallic paint £700



VX_MOK_31269

Power Red (GD6)**
Two-coat premium metallic paint £700



VX_MOK_31266

The colours reproduced may vary slightly from the actual paint colour. As a result they should be used as a guide only. Your Vauxhall Retailer has a comprehensive display of our paint samples.

*Standard exterior paint for Mokka. **Optional at extra cost including VAT. †Optional at extra cost including VAT. Not available on SRi Premium models.

Roof, Bonnet and Window Moulding Colours

							Electric models			
	SE Edition	SRi Premium	Elite Edition	Elite Premium	Ultimate	SE Premium	SRi Premium	Elite Premium	Ultimate	
Roof Colours										
Body-coloured roof	●	No-cost	No-cost	No-cost	No-cost	●	No-cost	No-cost	No-cost	
Black roof		●	●	●	●		●	●	●	
White roof*		£300	£300	£300	£300		£300	£300	£300	
Red roof**		£300					£300			
Bonnet Colours										
Black bonnet		£200	£200	£200	£200		£200	£200	£200	
Window Moulding Colours										
Chrome-effect window moulding	●		●	●	●	●		●	●	
Red upper window moulding [†]		●					●			
Black upper window moulding ^{††}		No-cost					No-cost			



VX_MOK_31270

Black roof (22T)



VX_MOK_31271

White roof (03T)*



VX_MOK_31272

Red roof (34V)**







VX_MOK_31273

Black bonnet (CNP)

*Optional at extra cost including VAT. Not available with White Jade/Voltaic Blue/Mamba Green. **Optional at extra cost including VAT. Not available with Power Red/Voltaic Blue/Mamba Green body colours.
[†]Not available with Mamba Green/Power Red/Voltaic Blue body colours/white roof/red roof. ^{††}Standard with Power Red body colour.

Wheels and Tyres

						Electric models				
		SE Edition	SRi Premium	Elite Edition	Elite Premium	Ultimate	SE Premium	SRi Premium	Elite Premium	Ultimate
 VX_MOK_31304_WR6	16-inch silver alloy wheels • 215/65 R 16 Tyres • Emergency tyre inflation kit (in lieu of spare wheel)	●					●			
 VX_MOK_31279_RV6	18-inch bi-colour alloy wheels with red accents • 215/55 R 18 tyres • Emergency tyre inflation kit (in lieu of spare wheel)		●					●		
 VX_MOK_31280_RNW	17-inch bi-colour alloy wheels • 215/60 R 17 tyres • Emergency tyre inflation kit (in lieu of spare wheel)			●	●				●	
 VX_MOK_31314_RSX	18-inch bi-colour alloy wheels • 215/55 R 18 tyres • Emergency tyre inflation kit (in lieu of spare wheel)					●				●
Provision for spare wheel fitment (spare wheel is Retailer-fit)		£20*	£20*	£20*	£20*	£20*				

*Optional at extra cost including VAT.

Petrol Engines

	1.2 (100PS) Turbo	1.2 (130PS) Turbo with 6-speed manual	1.2 (130PS) Turbo with 8-speed automatic
Capacity	1199cc	1199cc	1199cc
Maximum power	100PS (75kW) @ 5500rpm	130PS (96kW) @ 5500rpm	130PS (96kW) @ 5500rpm
Maximum torque	205Nm (151lb.ft.) @1750rpm	230Nm (169lb.ft.) @1750rpm	230Nm (169lb.ft.) @1750rpm
Configuration	3 cylinders, 4 valves per cylinder, double overhead camshafts	3 cylinders, 4 valves per cylinder, double overhead camshafts	3 cylinders, 4 valves per cylinder, double overhead camshafts
Fuel/induction system	Turbocharger with intercooler. Multi-point sequential fuel injection	Turbocharger with intercooler. Multi-point sequential fuel injection	Turbocharger with intercooler. Multi-point sequential fuel injection
Emission compliance	Euro 6d	Euro 6d	Euro 6d
Service interval	12,500 miles or 1 year (whichever occurs sooner)	12,500 miles or 1 year (whichever occurs sooner)	12,500 miles or 1 year (whichever occurs sooner)

Diesel Engine

	1.5 (110PS) Turbo D
Capacity	1499cc
Maximum power	110PS (81kW) @ 3500rpm
Maximum torque	250Nm (184lb.ft.) @ 1750rpm
Configuration	4 cylinders, 4 valves per cylinder, double overhead camshafts
Fuel/induction system	Turbocharger with intercooler. Variable Valve Timing (VVT). Spark ignited direct injection (SIDI)
Emission compliance	Euro 6d
Service interval	20,000 miles or 1 year (whichever occurs sooner)

Performance, Fuel Economy and Emissions

	Performance (manufacturer's figures)		Fuel economy mpg (litres/100km) [#]		CO ₂ emissions g/km [#]		Vehicle Excise Duty*		BiK rates from - 2022/23 tax year
	Maximum speed (mph)	Acceleration 0-60mph (sec)	Combined Low	Combined High	Combined Low	Combined High	First year rate	Standard rate	
1.2 (100PS) Turbo	116	10.6	49.6 (5.7)	51.4 (5.5)	124	128	£190	£165	30%
1.2 (130PS) Turbo	125	9.1	50.4 (5.6)	51.4 (5.5)	123	126	£190	£165	30%
1.2 (130PS) Turbo automatic	124	9.2	47.1 (6.0)	47.9 (5.9)	133	137	£230	£165	32%
1.5 (110PS) Turbo D	118	10.8	62.8 (4.5)	65.7 (4.3)	114	117	£190	£165	27%

Weights and Towing Data_{kg}

	Gross vehicle weight	Maximum towing weights Trailer with brakes (without brakes)
1.2 (100PS) Turbo	1700	1200 (620)
1.2 (130PS) Turbo	1715	1200 (620)
1.2 (130PS) Turbo automatic	1740	1200 (640)
1.5 (110PS) Turbo D	1750	1200 (640)

[#]Figures shown are for comparison purposes and should only be compared to the fuel consumption and CO₂ values of other cars tested to the same technical standard. The fuel consumption achieved, and CO₂ produced, in real world conditions will depend upon a number of factors including, but not limited to: the accessories fitted (pre and post registration); variations in weather; driving styles and vehicle load. The WLTP (Worldwide Harmonised Light Vehicles Test Procedure) is used to measure fuel consumption and CO₂ figures. The CO₂ figures display a range to reflect the highest value for the highest emitting version with all available options added, through to a minimum value to represent the lowest emitting version in standard specification.

*Correct at time of publication.

Please note: Gross vehicle weight is the total permissible weight of the vehicle including passengers and their luggage. The **maximum roof rack loading** should not exceed 70kg. The **maximum towing weights** are based on the ability of the car, with two occupants of 75kg each, to restart on a 12% gradient, which is approximately 1 in 8.3, at sea level. The permitted trailer load applies up to the specified incline and up to an altitude of 1000 metres above sea level. The permissible gross train weight decreases by 10% for every 1000 metres of additional altitude. At altitudes above 1500 metres, the engine output may drop with a corresponding reduction in towing capability. Any extra weight, such as luggage or additional passengers, should be deducted from the maximum towing weight. With a trailer fully loaded, **maximum noseweight** should not exceed 55kg. Always fit Vauxhall towing attachments and accessories available from your Vauxhall Retailer. They are designed specifically for Vauxhall models and carry a 12-month guarantee. During trailer towing do not exceed a maximum speed of 60mph. This speed limit is also applicable in countries with higher permitted speeds for trailer-vehicle combinations. Pay attention to the local speed limits. For trailers with low driving stability and caravans the use of an oscillation damper is strongly recommended.

Specifications

Transmission

- Front-wheel drive
- Six-speed manual gearbox
 - Available on 1.2 (100PS) Turbo/1.2 (130PS) Turbo/1.5 (110PS) Turbo D models.
- Eight-speed automatic transmission
 - Available on 1.2 (130PS) Turbo models.

Steering

- Single pinion electrical power steering

Brakes

- Anti-lock Braking System (ABS)
- Electronic brakeforce distribution
- Emergency brake assist
- Cornering brake control
- Straight line stability control

Petrol/diesel engines

Front ventilated discs: 283mm diameter

Rear drums: 249mm diameter

Electric engine

Front ventilated discs: 302mm diameter

Rear discs: 268mm diameter

Fuel tank capacity

– 1.2 (100PS) Turbo/1.2 (130PS) Turbo 44 litres (9.7 gallons)

– 1.5 (110PS) Turbo D 41 litres (9.0 gallons)

AdBlue® Tank Capacity

– 15 litres (3.3 gallons)

Start/Stop technology

Mokka's Start/Stop system offers real benefits by improving fuel economy and reducing CO₂ emissions, particularly in town. It does this by automatically stopping the engine when you come to a standstill, and then restarting as you prepare to move off.

Before automatically stopping the engine a number of system checks are carried out to ensure that it is both safe and practical to do so. To ensure safety, the driver must depress the clutch pedal, shift in to neutral, and then release the clutch pedal.

System checks carried out before Auto Stop activates include:

- Start/Stop system is not manually deactivated via the facia button
- Sufficient brake vacuum is available to prevent the car rolling down an incline
- Battery is in good condition and charged
- Outside air temperature and engine temperature are above specified minima
- Electronic climate control (where fitted) is not in maximum heating or maximum cooling mode
- Self-cleaning function of the diesel particulate filter is not active

If all of these conditions are satisfied then the vehicle will Auto Stop.

When you are ready to pull away from standstill, Auto Restart is activated by depressing the clutch pedal.

Whilst at a standstill the vehicle is continually monitored. If necessary, the engine will automatically be restarted. Conditions that would initiate an Auto Restart include:

- Low battery level
- Brake vacuum below specified minimum
- Start/Stop system is manually deactivated
- Stationary for 5.5 minutes

Mokka-e Specifications

Single-speed electronic drive selector

As the motor is an all-electric single-speed drive unit, there is no need for multiple gears. Instead, the shifter lets the driver select from the following:

- Park
- Reverse
- Neutral
- Drive
- Braking (for increased regenerative braking)

Drive Mode Selector

The driver can determine the driving style through selecting one of the following modes:

- **Sport:** for a dynamic drive with a responsive throttle and the highest top speed and torque
- **Normal:** for a balanced drive that offers a compromise between performance and energy efficiency
- **ECO:** for maximum range and energy efficiency. The ECO mode deactivates all unnecessary energy-consuming features and reduces the top speed, torque and overall performance

Drivetrain	Mokka-e
CO ₂ emissions	0g/km
Maximum power	100kW (136PS)
Maximum torque	260Nm (192lb. ft.)
Acceleration 0-60mph	9.2 sec
Maximum speed	93mph
Transmission	Automatic electric drive with fixed gear ratio
Service interval	Initial inspection at 8,000 miles/1 year (whichever comes sooner). Thereafter 16,000 miles/2 years (whichever comes sooner)

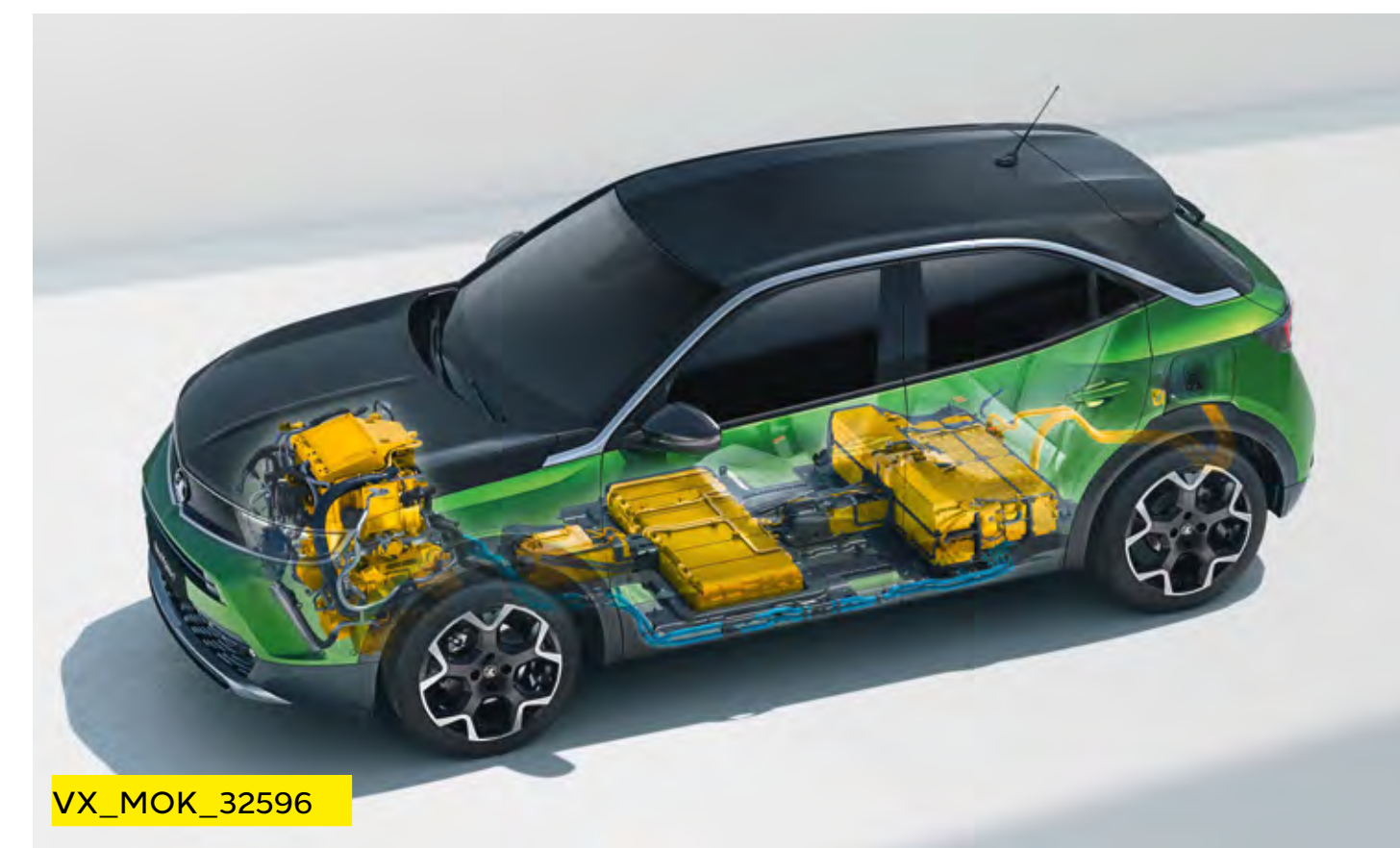

Mokka-e Specifications

Charging

Mokka-e comes fitted with an 11kW on-board charger and mode 3 cable.

The charging flap's Padlock LED lights up when the cable is correctly plugged in and locked and then acts as a user interface to show the charging status via coloured LED lights:

- **White:** welcome light that helps to light up the area, especially useful in dark conditions
- **Flashing green:** charging in progress
- **Solid green:** charging complete
- **Solid blue:** delayed charging toggled; changes to flashing green when charging commences
- **Solid red:** malfunction

The driver may also choose from two settings:

- **Immediate charging (the standard setting):** Starts charging as soon as the vehicle is docked for charging
- **Delayed charging:** This is especially useful for when cheaper electric rates are desired, e.g. charging at night. Simply enter a charging start time

Please note, EV range assumes that vehicle has been pre-conditioned prior to journey. This function can be accessed either via MyVauxhall App (standard with all Mokka-e) or by using the Multimedia Navi Pro infotainment system (standard on SRi Premium, Elite Premium and Ultimate).

Charging		
Supply	Socket	Charge Time (0-100%)
AC current - Domestic 3 pin socket (2.3kW)	Type 2	21h 45m
AC current - Home wallbox or public charger (7kW)	Type 2	7h 30m
AC current - Public charger (11kW)*	Type 2	5h
DC current - Rapid charger (100kW)	CCS	30m (0-80%)

Battery	
Battery capacity	50kWh
AC on-board charger speed (standard)	11kW
EV range (WLTP high)	209 miles
Energy consumption (Combined low/high)	15.8-16.2kWh/100km
Battery warranty	8 years/100,000 miles/70% capacity



The Mokka-e is a battery electric vehicle requiring mains electricity for charging. Range data given has been determined according to WLTP test procedure methodology. The figures shown are intended for comparability purposes only and should only be compared to other cars tested to the same technical standard. The range you achieve under real world driving conditions will depend upon a number of factors, including but not limited to: the accessories fitted (pre and post registration); charging frequency; personal driving style; vehicle load and route characteristics; variations in weather; heating/air conditioning; pre-conditioning and battery condition. For more information, contact your local Vauxhall Retailer.

*Requires optional 11kW on board charger.

Dimensions and Capacities

All measurements in mm (inches) unless stated otherwise.



Loadspace Dimensions	Mokka	Mokka-e
Maximum length behind rear seats	667 (26.3)	667 (26.3)
Maximum length rear seats folded	1418 (55.8)	1418 (55.8)
Maximum width	1021 (40.2)	1021 (40.2)
Maximum height	780 (30.7)	780 (30.7)

Luggage Capacities Litres (cu.ft.)	Mokka	Mokka-e
Rear seats up (under luggage compartment cover)	350 (12.37)	310 (10.9)
Rear seats folded (to roof)	1105 (39.0)	1060 (37.4)

Accessories

Safety Total (inc. VAT)

Spare wheel kit with 16-inch emergency wheel and tool kit (petrol and diesel models only) ¹	£167
Philips ADR620 dash cam	£109
Front parking sensors	£390
Rear parking sensors	£407
Child seats ²	
- Group 0 (0-13kg) – Britax Romer Baby Safe	£239
- ISOFIX Base, Rear-facing for Britax Romer Baby Safe	£251
- Group 2/3 (15-36kg) – Britax Romer KIDFIX 2 R	£317
- Group 2/3 (15-36kg) – Britax Romer KIDFIX XP	£352
- Group 3 (22-36kg) – Booster Seat without Seatback	£76
Safety Pack – first aid kit, hi-vis vest and warning triangle	£16
Warning triangle	£9
Hi-vis safety vest – adult	£4
Hi-vis safety vest – child 3-6 years (42cm)	£4
Hi-vis safety vest – child 7-12 years (52cm)	£4
First aid kit	£15
Emergency seat belt cutter and hammer	£19
Fire extinguisher (1kg) with strap	£33
Under seat bracket for fire extinguisher	£48

Protection Total (inc. VAT)

Floor mats (set of 4)	
- Carpet	£43
- Rubber	£53
- Velour	£74
Rear seat cover	£40
Boot area cover	£54
Reversible boot tray	£81
Rear bumper protection	£100
Front and rear splash guards ³	£100

Comfort

USB charger – 2 front and 2 rear ports	£28
FlexConnect bracket	£20
FlexConnect hook	£37
FlexConnect coat hanger	£41
FlexConnect folding table	£102
FlexConnect iPad Mini holder	£127
FlexConnect iPad holder	£106
FlexConnect iPad Air holder	£106
FlexConnect Samsung Galaxy 10.1 holder	£127
Rear cup holder	£56
Cupholder organisers	£8-10
Smoker's pack	£53
Fragrance diffuser	£24
Fragrance cartridge	£18
Wireless phone charger	£171

Style Total (inc. VAT)

Stainless steel door sill covers (front)	£41
Sport pedal covers – Auto	£44
Sport pedal covers – Manual	£63
Exterior door mirror covers	
- Various colours	£111
Rear-view mirror cover ⁴	
- Various colours	£64
Decal kit with roof and bonnet racing stripes	
- Black	£244
- White	£271
Decal kit with side stripes	
- Black	£222
- White	£256
18-inch diamond-cut bi-colour alloy wheels	
- Set of 4	£1,377
Alloy wheel inserts ⁵ – various colours	
- Set of 4	£32-36
- Each	£20
Alloy wheel centre caps ⁵ – various colours	£15
Chrome valve caps	£10

Transport solutions Total (inc. VAT)

Towing	
Tow bar with removable tow ball and 13-track wiring loom ⁶	£827
Towing harness socket adaptor (13- to 7-pin)	£30

Electric

Mode 2 emergency charging cable (Type G – UK domestic plug)	£584
Mode 3 charging cable	
- 7.4kW	£331
- 11kW	£371
- 22kW	£438
Cable bag	£49
Mode 2 Universal Charger UK kit (22kW)	£1,555
Accessories for Universal Charger	
- Wall bracket	£105
- Bag	£65
- Safety lock	£20
- Adapter Type 2	£318
- Adapter Type 3c	£358
- Adapter (various)	£120

Please note: Prices shown are fully fitted and painted, where applicable and include VAT. Please check with your local Vauxhall Retailer for details. It is advisable to ensure your insurance policy is adequate to cover additional fitted accessories. Prices correct at time of publication.

¹Vehicle must be ordered with spare wheel fixing option (T7Y) in order to accommodate the spare wheel. ²Restrictions apply to the use of child seats, please consult your vehicle user manual or Vauxhall Retailer. ³Side steps and splash guards are not available together.

⁴Only available with anti-dazzle rear-view mirror. ⁵Only for use with 18-inch diamond-cut alloy wheels. ⁶Available on petrol and diesel models only.

Company Car Driver and Fleet Information

Benefit in kind company car taxation*

The car benefit charge will be the car's list price (including VAT, options and accessories fitted, delivery to Retailer and number plates, but excluding Vehicle Excise Duty and new vehicle first registration fee) multiplied by the percentage charge for the CO₂ emissions band in which the car falls (see table opposite). Multiply this figure by your personal income tax rate (20%** for Basic Rate, 40%** for Higher Rate) to calculate your annual benefit in kind tax liability.

Generic example:

ELECTRIC vehicle: 0g/km CO₂

On-the-road RRP	£27,305.00
Deduct: Vehicle Excise Duty	£0.00
New vehicle first registration fee	-£55.00
Effective list price	£27,250.00
Add: Optional two-coat metallic paint	£600.00
List price for tax purposes (P11D value)	£27,850.00
Car benefit charge 2022-23 tax year (2%)	£557.00
Benefit in kind tax liability	
Basic Rate (20%) tax payer	£111.40
Higher Rate (40%) tax payer	£222.80

*Please note this Price Guide provides taxation information as a guide only. Vauxhall does not provide taxation guidance. Drivers should always take professional advice on their own tax position.
**Excludes residents of Scotland.

BiK for Scottish Residents

Effective 6 April 2018 the Scottish Government have introduced their own BiK taxation structure. This only applies to Company Car Drivers that are Scottish taxpayers. HMRC will determine whether or not an individual is a Scottish taxpayer based on where their main place of residence is.

The BiK rates for Scotland are:

- Over £12,570 - £14,732 Starter Rate 19%
- Over £14,732 - £25,688 Basic Rate 20%
- Over £25,688 - £43,662 Intermediate Rate 21%
- Over £43,662 - £150,000 Higher Rate 41%
- Above £150,000 Top Rate 46%

CO ₂ emissions (g/km)	Percentage of cars price to be taxed 2022-23 tax year
Up to 50	14%
51 - 54	15%
55 - 59	16%
60 - 64	17%
65 - 69	18%
70 - 74	19%
75 - 79	20%
80 - 84	21%
85 - 89	22%
90 - 94	23%
95 - 99	24%
100 - 104	25%
105 - 109	26%
110 - 114	27%
115 - 119	28%
120 - 124	29%
125 - 129	30%
130 - 134	31%
135 - 139	32%
140 - 144	33%
145 - 149	34%
150 - 154	35%
155 - 159	36%
160 - 164	37%
165 - 169	37%
170+	37%

CO ₂ emissions (g/km)	Electric range (miles)	Percentage of cars price to be taxed 2022-23 tax year
0	-	2%
1 - 50	130+	2%
1 - 50	70 - 129	5%
1 - 50	40 - 69	8%
1 - 50	30 - 39	12%
1 - 50	<30	14%

To calculate your own personal liability, search: **Vauxhall BiK**, or click the link below:
[Vauxhall BiK Tool](#)

Fleet Toolbox

Discover the facts in our online Toolbox for both Company Car Drivers and Fleet Decision Makers. The Fleet Toolbox has a host of useful calculators, comparators, interactive listings and information.

Search Vauxhall Fleet Tools or click the link below:
[Vauxhall Fleet Tool Box](#)

Contact Vauxhall Fleet

Please contact one of our dedicated sales teams who will be happy to help with your particular enquiry.

Company Car Drivers

Call: 0345 111 2020

Email: company-car@vauxhallinfo.co.uk

Telephone lines are open

- Monday to Friday 8:00am-9:00pm

- Saturday and Sunday 9:00am-6:00pm

Fleet Decision Makers

Depending on the size of your fleet of vehicles, we have a dedicated team to handle your enquiries. The lines are open Monday to Friday excluding Bank Holidays.

1-24 vehicles

Call: 0845 076 2254 (8:30am-5:00pm)

25+ vehicles

Call: 0330 587 8222 (8:30am-5:00pm)

Email: vauxhallfleet@vauxhall.co.uk

Special Vehicles (Police, Fire and Ambulance)

Call: 01582 409999 (8:30am-5:00pm)

Email: vauxhallspecialvehicles@vauxhall.co.uk

For more information visit vauxhall.co.uk/fleet

Further Information

On-the-road prices

To eliminate uncertainty about hidden costs when buying a new car, Vauxhall publishes on-the-road recommended retail prices (RRP) and these are shown in the pricing tables within this price guide. These prices include VAT, number plates and delivery to Retailer of £700.00 (including £116.67 VAT), 12 months' Government Vehicle Excise Duty (see opposite for details) and the DVLA new vehicle first registration fee of £55.00.*

Please note: The on-the-road recommended retail price (RRP) does not include fuel supplied by the Retailer, motor insurance or any other goods or services supplied by agreement between the Retailer and the customer.

Price protection

Order a new Vauxhall for build in the current model year (as confirmed by your Retailer) for delivery no more than three months in advance and the price you are quoted is the price you pay. This is irrespective of any subsequent price rises between placing your order and delivery of your new car, but you must take delivery as soon as the car is available.

Please note: Price protection does not apply to Mokka-e/Corsa-e/Grandland X hybrid models. Vauxhall Motors Limited is not liable for price adjustments caused by Government changes in the rate of VAT (currently 20%), Vehicle Excise Duty, DVLA new vehicle first registration fee or by any other applicable legislation or regulations.

In the event of an accident

Vauxhall Accident Management helps keep you mobile following an accident. Benefits include vehicle recovery, Vauxhall-approved repairs and contacting your insurer. For more details, visit vauxhall.co.uk/AccidentManagement

Free2Move Lease

Whether you're a big company or a small business looking for vehicle financing, Free2Move Lease, our business finance specialists, can deliver exactly what you need.

Free2Move Lease is one of the UK's largest leasing companies and is also a member of the British Vehicle Rental and Leasing Association (BVRLA).

With over 60,000 vehicles in the Free2Move Lease portfolio, Free2Move Lease is able to offer competitive vehicle solutions. In addition, Free2Move Lease also offer innovative connected management of servicing and maintenance.

For further information, please contact your local Vauxhall Retailer or visit vauxhall.co.uk/offers-finance/business-leasing.html

Vehicle Excise Duty

The amount of Vehicle Excise Duty (road fund licence) payable on new cars varies depending on the level of carbon dioxide (CO₂) emissions produced by the vehicle. CO₂ emissions are measured in grams per kilometre (g/km) travelled and divided into 13 charging bands shown in the table opposite.

A 'first year rate' of Vehicle Excise Duty is payable on all new cars and in subsequent years the amount payable reverts to the 'standard rate'. From 1 April 2017 the breakpoints for each of these bands have been revised. Also, for vehicles with a list price over £40,000, including factory-fitted options, an additional £335 is payable for the first five years of standard rate payments.

Vehicle Excise Duty*

Band	CO ₂ emissions in grams per kilometre	First year rate Petrol/Diesel	Standard rate Petrol/Diesel	Standard rate Electric
A	0	£0	£0	£0
B	1 – 50	£10	£165	–
C	51 – 75	£25	£165	–
D	76 – 90	£120	£165	–
E	91 – 100	£150	£165	–
F	101 – 110	£170	£165	–
G	111 – 130	£190	£165	–
H	131 – 150	£230	£165	–
I	151 – 170	£585	£165	–
J	171 – 190	£945	£165	–
K	191 – 225	£1,420	£165	–
L	226 – 255	£2,015	£165	–
M	Over 255	£2,365	£165	–

*Correct at time of issue.

Further Information

Customer Care Commitment

For added peace of mind, Vauxhall has an innovative Customer Care Commitment that offers the following:

- Three-year vehicle warranty consisting of a one-year/unlimited mileage manufacturer's warranty and a second and third year manufacturer's warranty with a 60,000 miles limitation
- Vauxhall Assistance for 12 months from first registration
- Six years' body panel anti-perforation warranty

Please note: Warranty is only available on vehicles sourced from Vauxhall Motors Limited. Terms and conditions apply – please see your Vauxhall Retailer for details.

Vauxhall Assistance

Vauxhall Assistance is provided automatically with every new Vauxhall for 12 months from first registration and covers everything from accident assistance, roadside recovery and 'at home' service to flat tyres. For even more peace of mind, on Mokka-e models the cover is extended* to 8 years or 100,000 miles, whichever comes first. Even more reason for you to stay calm and let us take care of everything should the need arise. With Vauxhall Assistance help is literally just a free** phone call away, 24 hours a day, 365 days a year!

Protecting the environment

Vauxhall's commitment to the environment is demonstrated by our products' many environmental awards. For even more information on Vauxhall's efforts to achieve an environmentally sustainable future, and how to dispose of your end-of-life vehicle, see vauxhall.co.uk/recycling

Vauxhall Care

This all-inclusive service package is available on Vauxhalls under 10 months old (from date of first registration).

This package offers complete peace of mind for the first 3 years of your Vauxhall's life with fixed monthly payments for the plan duration.

- **3 years' Vauxhall servicing** – covers first, second and third annual services. Including a brake-fluid change in the second service
- **2 years' Vauxhall Roadside Assistance** – first year from us
- **First years' MOT[†]** – free of charge by your local Vauxhall Retailer

For full terms and conditions and to sign up, visit: vauxhall.co.uk/vauxhallcare

Vauxhall Service Club

Vauxhall Service Club is available for all Vauxhall owners, and it's free to join. Members benefit from the following:

- 15% off Vauxhall Approved Accessories
- Vauxhall's aged 2-3 Years = 15% off parts and labour
- Vauxhall's aged over 3 Years = 25% off parts and labour
- Half price MOT's (NI excluded)
- Free pre-MOT test inspection (NI only)
- Fixed price AdBlue® Refills
 - Car = £14.99
 - Van = £24.99
- Access to the Vauxhall Accident Management Programme
- Online service booking available 24/7 with servicing appointments available within 3 days – [Book Online](#)
- Collection and delivery/onward mobility options
- Complimentary 'Wash and Vac' with all routine services^{††}
- Vauxhall trained technicians
- Genuine Vauxhall parts
- Minimum 12 months warranty on parts and labour
- Regular newsletters with exclusive offers, discounts and competitions

Terms and conditions apply. To join visit: vauxhall.co.uk/serviceclub

Vauxhall Insurance with added reassurance

Comprehensive cover – Summary of benefits

- Competitive premiums
- Repairs by a Vauxhall-trained technician
- Genuine Vauxhall parts, guaranteed for five years when we repair your car within our Approved Repairer Network
- Free courtesy car as standard when using an Approved Repairer[‡]
- 24 hour claims helpline
- Personal Accident benefit
- Cover for audio equipment
- Windscreen cover

Call for a quote on 0330 678 1130^{‡‡}

For more product information

For further information on the Vauxhall range or location of your nearest Vauxhall Retailer please call 0345 600 1500. Alternatively, details can be found on our website at vauxhall.co.uk

For more information call **0345 600 1500**

For Fleet enquiries call **0330 587 8222**

Discover the full Vauxhall range at **[vauxhall.co.uk](https://www.vauxhall.co.uk)**

Join us online

The invoice price, including delivery to Retailer, factory-fitted options, accessories fitted by the Retailer and number plates, is subject to VAT. Some feature descriptions in this guide may refer to, and some illustrations may show, optional equipment not included in the standard delivery. The information contained in this guide was accurate at the time of publication. We reserve the right to make changes in design and equipment. Please note that Vauxhall Retailers are not the agents of Vauxhall Motors Limited and are not authorised to bind Vauxhall Motors Limited by any specific or implied undertaking or representation. It is advisable to ensure that your motor insurance policy provides adequate cover for additional fitted options and accessories. The colours in this guide are only approximate actual colours. Illustrated optional equipment is available at extra charge. Availability, technical features and equipment provided on our vehicles can vary by model. For precise information on the equipment provided on our vehicles, please contact your local Vauxhall Retailer.

VAUXHALL

Price and Specification Guide
6 April 2022 | Model Year 2022C



Crossland

Contents

To find the information you want use the links below to navigate around the guide:

PureTechnology

Choose Your Trim Level

Range Highlights

Models

Prices

PureSense

PureConnect

Comfort and Convenience

Safety and Security

Lighting

Styling

Exterior Colours

Wheels and Tyres

Specifications

Dimensions and Capacities

Accessories

Company Car Information

Further Information

PureTechnology

The Crossland is Vauxhall's most practical SUV that not only looks great but is prepared to up the ante with innovative automotive technology. Like a front camera safety system and a panoramic rear-view camera.

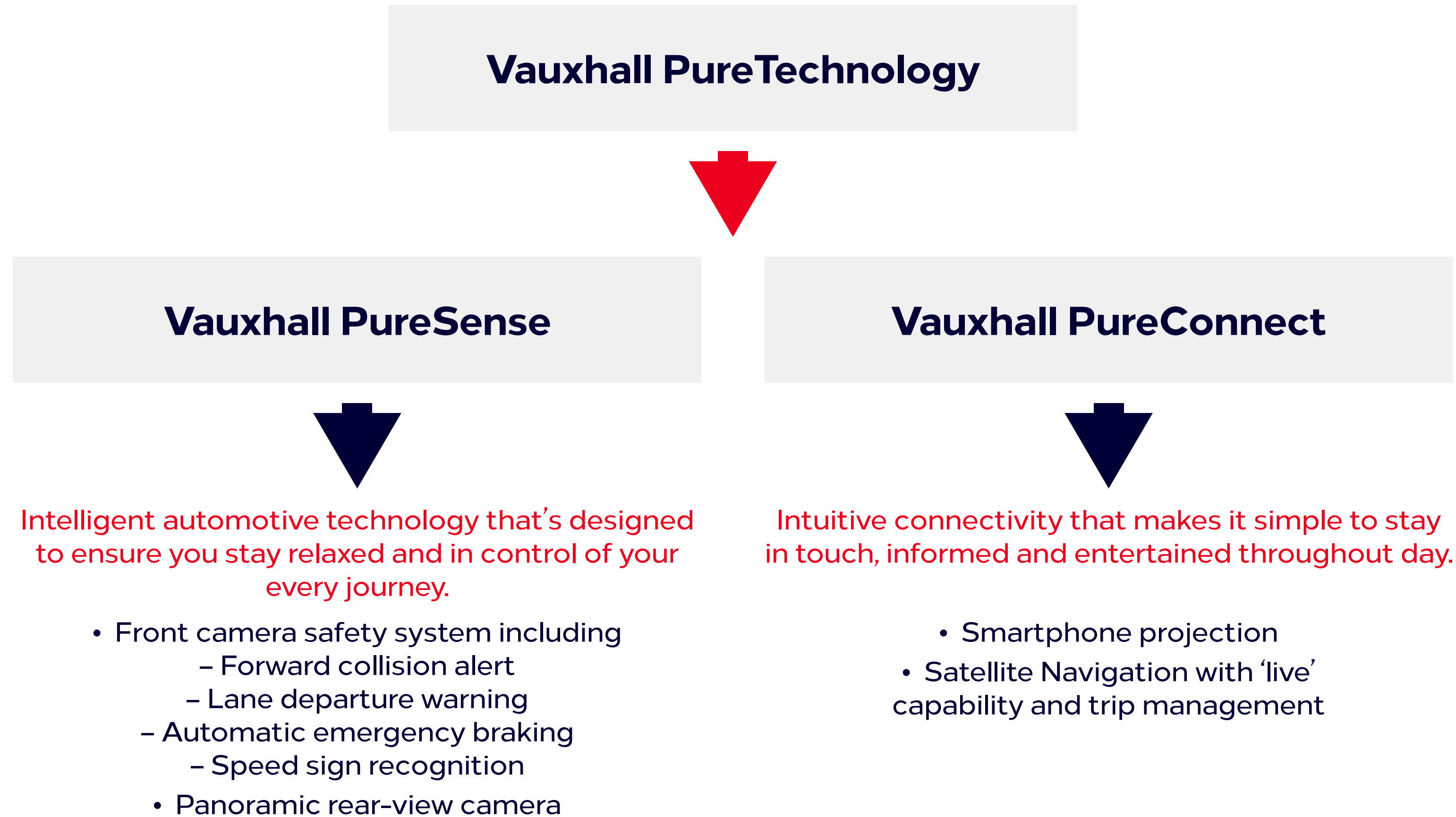

Choose Your Trim Level

Design



Design is Crossland's entry level trim which has a high level of specification as standard including the 7-inch colour touchscreen with smartphone projection, air-con and cruise control.

GS Line



Opt for GS Line for a touch of sportiness in your Crossland. Offering the visual appeal with a black roof, dark-tinted rear windows, 17-inch black alloy wheels and an interior that's unique to the GS Line.

It's sporty from the inside out but still offering the practicality and versatility needed for every day family life.

Ultimate



The top of the range Crossland – Ultimate has everything from Alcantara interior trim to satellite navigation.

Crossland Range Highlights

Design

Standard features include:

PureSense

- LED headlights
- Automatic lighting control
- Lane departure warning
- Speed sign recognition
- Driver drowsiness alert
- Forward collision alert (all speed)
- Automatic emergency braking with pedestrian detection
- Cruise control with speed limiter
- Hill start assist

PureConnect

- Multimedia infotainment system
 - 7-inch colour touchscreen
 - AM/FM/DAB digital radio
 - Bluetooth®
 - Apple CarPlay/Android Auto™
 - USB connection
- Six speakers

Comfort and Convenience

- Air conditioning
- Leather-covered steering wheel
- Steering column adjustable for reach/rake
- 60/40 split-folding rear seat back
- Rain-sensitive windscreen wipers
- Electrically operated front and rear windows
- Electrically adjustable/heated door mirrors
- Automatic anti-dazzle rear-view mirror

Styling

- 16-inch diamond-cut bi-colour five twin-spoke alloy wheels
- Black upper window moulding

GS Line

Features over Design models:

PureSense

- LED tail lights
- LED daytime running lights
- LED front fog lights
- Automatic high beam control and headlight levelling system
- Rear-view camera

PureConnect

- Multimedia Navi Pro infotainment system
 - 8-inch colour touchscreen
 - Satellite navigation
 - 2 x USB connections
- 3.5-inch colour instrument display

Comfort and Convenience

- Dual-zone electronic climate control
- Front centre armrest with storage
- Ergonomic active driver's seat (AGR-approved*)
- Remote control security alarm system

Styling

- 17-inch black five twin-spoke alloy wheels
- Black Griffin logo, vizor frame, rear lettering and skid plates
- Red or chrome upper window moulding**
- Dark-tinted rear windows
- Black roof

Ultimate

Features over GS Line models:

PureSense

- Panoramic rear-view camera

Comfort and Convenience

- Heated front seats
- Heated steering wheel
- Alcantara interior seat trim
- 12v rear seat power outlet
- Sliding 60/40 rear seat with centre rear seat armrest
- Load floor compartment FlexFloor with cargo under floor divider
- Keyless entry and start

Styling

- 17-inch diamond-cut bi-colour five twin-spoke alloy wheels
- Silver-effect side door mouldings
- Silver-effect roof rails
- Chrome-effect upper window moulding

Crossland Design



VX_CRO_33340

Design

OTR from £19,105

PureSense

- LED headlights
- Automatic lighting control
- Lane departure warning
- Speed sign recognition
- Driver drowsiness alert
- Forward collision alert (all speed)
- Automatic emergency braking with pedestrian detection
- Cruise control with speed limiter
- Hill start assist

PureConnect

- Multimedia infotainment system
 - 7-inch colour touchscreen
 - AM/FM/DAB digital radio
 - Bluetooth®
 - Apple CarPlay/Android Auto™
 - USB connection
- Six speakers

Comfort and Convenience

- Air conditioning
- Leather-covered steering wheel
- Steering column adjustable for reach/rake
- 60/40 split-folding rear seat back
- Rain-sensitive windscreen wipers
- Electrically operated front and rear windows
- Electrically adjustable/heated door mirrors
- Automatic anti-dazzle rear-view mirror

Styling

- 16-inch diamond-cut bi-colour five twin-spoke alloy wheels
- Black upper window moulding

Crossland GS Line



VX_CRO_33073

GS Line

OTR from £21,530

PureSense

- LED headlights and tail lights
- LED daytime running lights
- LED front fog lights
- Automatic lighting control
- Automatic high beam control and headlight levelling system
- Lane departure warning
- Speed sign recognition
- Driver drowsiness alert
- Forward collision alert (all speed)
- Automatic emergency braking with pedestrian detection
- Cruise control with speed limiter
- Hill start assist
- Rear-view camera

PureConnect

- Multimedia Navi Pro infotainment system
 - 8-inch colour touchscreen
 - Satellite navigation
 - AM/FM/DAB digital radio
 - Bluetooth®
 - Apple CarPlay/Android Auto™
 - 2 x USB connections
- Six speakers
- 3.5-inch colour instrument display

Comfort and Convenience

- Dual-zone electronic climate control
- Leather-covered steering wheel
- Steering column adjustable for reach/rake
- 60/40 split-folding rear seat back
- Rain-sensitive windscreen wipers
- Electrically operated front and rear windows
- Electrically adjustable/heated door mirrors
- Automatic anti-dazzle rear-view mirror
- Front centre armrest with storage
- Ergonomic active driver's seat (AGR-approved*)
- Remote control security alarm system

Styling

- 17-inch black five twin-spoke alloy wheels
- Black Griffin logo, vizor frame, rear lettering and skid plates
- Red or chrome upper window moulding**
- Dark-tinted rear windows
- Black roof

Crossland Ultimate



VX_CRO_33074

Ultimate OTR from £25,205

PureSense

- LED headlights and tail lights
- LED daytime running lights
- LED front fog lights
- Automatic lighting control
- Automatic high beam control and headlight levelling system
- Lane departure warning
- Speed sign recognition
- Driver drowsiness alert
- Forward collision alert (all speed)
- Automatic emergency braking with pedestrian detection
- Cruise control with speed limiter
- Hill start assist
- Panoramic rear-view camera

PureConnect

- Multimedia Navi Pro infotainment system
 - 8-inch colour touchscreen
 - Satellite navigation
 - AM/FM/DAB digital radio
 - Bluetooth®
 - Apple CarPlay/Android Auto™
 - 2 x USB connections
- Six speakers
- 3.5-inch colour instrument display

Comfort and Convenience

- Dual-zone electronic climate control
- Leather-covered steering wheel
- Steering column adjustable for reach/rake
- Rain-sensitive windscreen wipers
- Electrically operated front and rear windows
- Electrically adjustable/heated door mirrors
- Automatic anti-dazzle rear-view mirror
- 60/40 split-folding rear seat back
- Sliding 60/40 rear seat with centre rear seat armrest
- Load floor compartment FlexFloor with cargo under floor divider
- Front centre armrest with storage
- Ergonomic active driver's seat (AGR-approved*)
- Remote control security alarm system
- Heated front seats
- Heated steering wheel
- Alcantara interior seat trim
- 12v rear seat power outlet
- Keyless entry and start

Styling

- 17-inch diamond-cut bi-colour five twin-spoke alloy wheels
- Black Griffin logo, vizor frame, rear lettering and skid plates
- Chrome-effect upper window moulding
- Dark-tinted rear windows
- Black roof
- Silver-effect side door mouldings
- Silver-effect roof rails

Crossland Prices

	Pack Code	Fuel Type	Price (£)	VAT (£)	Total (£)	On-the-road RRP (£)	Financial Year 2022/23 BiK 20% (£)	WLTP Combined CO ₂ (g/km) [#] – pack code	Insurance groups
Design									
1.2 (83PS)	GD75 E1G1	Petrol	15,100.00	3,020.00	18,120.00	19,105.00	97.23	133	8E
1.2 (110PS) Turbo	GD75 EL61	Petrol	15,775.00	3,155.00	18,930.00	19,875.00	98.13	129	14E
1.2 (130PS) Turbo auto	GD75 EGF1	Petrol	17,491.67	3,498.33	20,990.00	21,975.00	115.67	136	16E
1.5 (110PS) Turbo D	GD75 HS61	Diesel	16,641.67	3,328.33	19,970.00	20,915.00	99.90	120	15E
GS Line									
1.2 (83PS)	GG75 E1G1	Petrol	17,120.83	3,424.17	20,545.00	21,530.00	113.30	135	10E
1.2 (110PS) Turbo	GG75 EL61	Petrol	17,795.83	3,559.17	21,355.00	22,340.00	113.95	132	16E
1.2 (130PS) Turbo auto	GG75 EGF1	Petrol	19,545.83	3,909.17	23,455.00	24,440.00	128.82	138	18E
1.5 (110PS) Turbo D	GG75 HS61	Diesel	18,662.50	3,732.50	22,395.00	23,340.00	111.62	122	17E
Ultimate									
1.2 (110PS) Turbo	GU75 EL61	Petrol	20,183.34	4,036.67	24,220.00	25,205.00	128.75	132	16E
1.2 (130PS) Turbo auto	GU75 EGF1	Petrol	21,966.67	4,393.33	26,360.00	27,345.00	144.32	139	tba
1.5 (110PS) Turbo D	GU75 HS61	Diesel	21,016.67	4,203.33	25,220.00	26,165.00	125.27	123	tba

Crossland's petrol and diesel engines meet the Real Driving Emissions Step 2 (RDE2) standards.

[#]Fuel consumption and CO₂ figures are determined according to the WLTP test cycle. CO₂ figures, BiK values and RRP pricing shown above are for a standard vehicle without any additional optional equipment. CO₂ figures are used to calculate Vehicle Excise Duty (VED) for the first registration of the vehicle and BiK. The addition of optional extras could increase the certified CO₂ emission output. This in turn may affect the amount of VED payable upon registration, and, for company car drivers, the P11D value and the amount of Benefit in Kind (BiK) tax payable. Figures shown are for comparison purposes and should only be compared to the fuel consumption and CO₂ values of other cars tested to the same technical standard. The fuel consumption achieved, and CO₂ produced, in real world conditions will depend upon a number of factors including, but not limited to: the accessories fitted (pre and post registration); variations in weather; driving styles and vehicle load. The WLTP (Worldwide Harmonised Light Vehicles Test Procedure) is used to measure fuel consumption and CO₂ figures. Full data relating to WLTP test cycles can be found at: www.vauxhall.co.uk/wltp

Please note: On-the-road recommended retail prices (RRP) include number plates and delivery to Retailer of £700.00 (inc. £116.67 VAT), 12 months' Vehicle Excise Duty and new vehicle first registration fee of £55.00. Excludes fuel and insurance. Company Car Benefit in Kind (BiK) rates are monthly based on the standard paint price. On-the-road prices feature a VED based on preliminary CO₂ information.

PureSense

Standard Features – The following features are standard across the entire Crossland range.
 Specific features by model are outlined in the separate tabular information.

Cruise control with speed limiter

With steering wheel mounted controls. Enables you to maintain a constant speed, making it ideal for economical motorway driving.

Rear-view mirror

- Automatically dimming anti-dazzle rear-view mirror

Speed sign recognition

Detects and then displays speed limits, reducing uncertainty and the risk of speeding.

- Recognises different speed signs, including temporary speed restrictions
- Displays reminder in the instrument cluster

Driver drowsiness alert

The system monitors driving time and driving behaviour to help prevent accidents caused by tiredness.

Automatic emergency braking with pedestrian detection

Front camera system

Monitors the traffic situation in front of the vehicle using the front camera to detect mobile and fixed cars as well as adult pedestrians. The system first warns you through a series of visual and audible alerts and should you not react quickly enough, will automatically brake the vehicle to avoid or mitigate the impact of front-end collisions.*

*Cycles, motorcycles, animals and other objects are not detected.

Lane departure warning

If the driver has not actively steered or signalled, the lane departure warning system warns when the car moves outside of lane markings at speeds above 37mph.

- Warning light in instrument cluster
- Audible warning
- Facia on/off switch

Forward collision alert

The system operates automatically and gives an audible warning as well as a visual warning when approaching another vehicle too quickly.

Please note, Vauxhall driver assistance systems are intended to support the driver within the system-imminent limitations. The driver remains responsible for the driving task at all times.

Model Specific Feature

	Design	GS Line	Ultimate
Driver Assistance			
Panoramic rear-view camera			●
Rear-view camera		●	

PureConnect

Standard Infotainment Features

Multimedia with 7-inch touchscreen

Standard on Design

Onboard features:

- 7-inch colour touchscreen
- DAB Digital radio
- RDS with Traffic Programme
- AM/FM stereo radio with 36 station presets
- Six speakers

Media connections:

- USB connection
- Bluetooth® A2DP audio streaming (Advanced Audio Distribution Profile)

Mobile phone portal:

- Bluetooth® connectivity
- Vehicle microphone
- Handsfree calls via steering wheel controls
- Phone book access – Contacts/last calls/missed calls etc. are mirrored on the display and are easily navigated using the touchscreen (features dependent on mobile phone).
- SMS read out and reply

Smartphone interface:

- Apple CarPlay
- Android Auto™
- Smartphone projection that allows operations via voice command, touchscreen and buttons to control apps and music playback

Additional features:

- Steering wheel mounted audio controls
- Flexible roof-mounted aerial

Multimedia Navi Pro with 8-inch Touchscreen

Standard on GS Line and Ultimate

Features as Multimedia, with the addition of:

- Satellite navigation system
- 2D/3D street level mapping
- European coverage
- Points-of-interest search
- Map updates via USB
- 1 extra USB connection

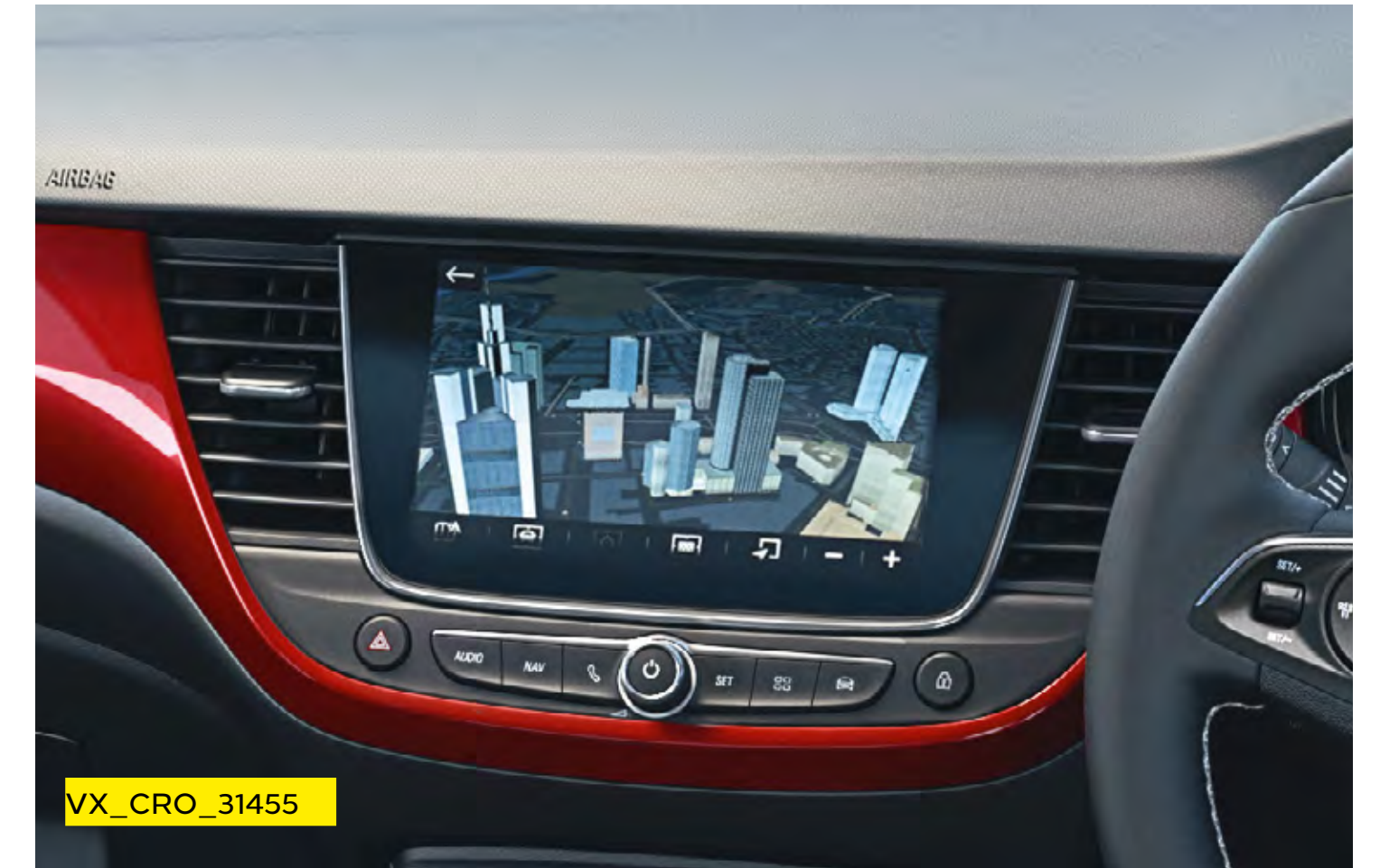

Please note that compatibility and certain functions may be different depending on the type of device and operating system you're using with the Multimedia systems. Apple CarPlay is a trademark of Apple Inc. Apple and iPhone are trademarks of Apple Inc., registered in the U.S. and other countries. Android is a trademark of Google Inc, also registered in the U.S. and other countries.

Please note, Apple CarPlay screen illustrated on 8-inch colour touchscreen on multimedia Navi Pro audio unit.

Standard Features – The following features are standard across the entire Crossland range.
Specific features by model are outlined in the separate tabular information.

Driver Information

Instrumentation

- Speedometer and rev counter
- Fuel gauge with low fuel level warning light
- Water temperature gauge with warning light
- Shift-up/down indication light – Indicates when to change gear for optimum fuel economy

Driver information display

(centrally located in instrument cluster)

- Trip computer data
- Total mileage
- Service-due indicator
- Oil life
- Tyre pressure monitoring system

Multi-function trip computer

(displayed on driver information display)

- Trip mileage
- Vehicle range based on remaining fuel
- Average speed
- Average fuel economy
- Instantaneous fuel economy

Central facia display

(format dependent on infotainment unit)

- Audio information
- Digital clock with automatic RDS time adjustment
- Outside air temperature with ice warning function
- Additional features dependent on infotainment unit (see infotainment for details)

Model Specific Feature

	Design	GS Line	Ultimate
Driver Information			
3.5-inch colour instrument display		●	●

Comfort and Convenience

Standard Features – The following features are standard across the entire Crossland range.
Specific features by model are outlined in the separate tabular information.

Interior Convenience

- Front 12-volt electrical accessory socket
- Driver’s and front passenger’s illuminated vanity mirrors with flip-up cover
- Reach and rake-adjustable steering
- Steering wheel mounted audio/phone/cruise controls
- Automatically dimming anti-dazzle rear-view mirror

Interior Storage

- Glovebox with lid
- Front door pockets with 1.5-litre bottle holder
- Rear door pockets with 0.5-litre bottle holder
- Two drinks holders in centre console
- Open storage compartment in centre console

Luggage Area

- Luggage compartment foldable cover
- Illuminated luggage area
- Fully carpeted luggage area

Model Specific Features

	Design	GS Line	Ultimate
Interior Convenience			
Front centre armrest with storage		●	●
12v rear seat power outlet		●	●
Storage pockets on front seat backs		●	●
60/40 split-folding rear seat back	●	●	
Versatility Pack – Sliding 60/40 rear seat back with centre rear seat armrest/Centre rear head restraint/ Load floor compartment FlexFloor with cargo under floor divider			●

Standard Features – The following features are standard across the entire Crossland range.
 Specific features by model are outlined in the separate tabular information.

Heating and Ventilation

- Air recirculation facility
- Cabin particulate filter – Removes dust, airborne particles and pollen
- Multi-speed fan
- Illuminated controls
- Four adjustable facia vents
- Windscreen demist vents
- Side window demist vents

Windows

- Electrically operated front and rear windows with safety autoreverse and one-touch up/down facility
- Heated rear window
- Tinted windows
- Solar heat-absorbing windscreen, rear windows and tailgate windows

Door mirrors

- Twin electrically adjustable/heated door mirrors

Wipers

- Rain-sensitive windscreen wipers

Model Specific Features/Option

	Design	GS Line	Ultimate
Heating and Ventilation			
Air conditioning	●		
Dual-zone electronic climate control		●	●
Winter Pack – Heated front seats/Heated steering wheel		£350*	●
Exterior Convenience			
Remote control security alarm system		●	●
Keyless entry and start			●

*Optional at extra cost including VAT.

Design



Steering wheel:

- Three-spoke design
- Leather-covered steering wheel
- Satin chrome-effect bezel

Facia and door trim:

- Black facia with silver trim inserts
- Black trim inserts on front doors

Seating:

- Driver's seat (four-way adjustable)
 - Height
 - Reach
 - Backrest
 - Head restraint
- Front passenger's seat (two-way adjustable)
 - Reach
 - Backrest
 - Head restraint
- 60/40 split-folding rear seat back

Seat trim:

- Peanut jet black fabric seat trim inserts
- Jet black fabric side bolsters

GS Line



Steering wheel:

- Three-spoke design
- Leather-covered steering wheel
- Satin chrome-effect bezel

Facia and door trim:

- Black facia with red trim inserts
- Red trim inserts on front doors

Seating:

- Ergonomic active driver's seat (AGR-approved*) (eight-way adjustable)
 - Height - Reach - Backrest
 - Seat cushion extension
 - Lumbar adjustment (four-way electrical)
 - Head restraint

- Front passenger's seat (eight-way adjustable)
 - Height - Reach - Backrest
 - Seat cushion extension - Head restraint
- 60/40 split-folding rear seat back

Seat trim:

- Banda jet black/Rubar red fabric seat trim inserts
- Jet black premium leather-effect side bolsters

VX_CRO_32748

*AGR (The Campaign for Healthier Backs) is an independent centre of excellence for ergonomics, based in Germany.

Ultimate



Steering wheel:

- Three-spoke design
- Heated leather-covered steering wheel
- Satin chrome-effect bezel

Facia and door trim:

- Black facia with silver trim inserts
- Black trim inserts on front doors

Seating:

- Ergonomic active driver's and front passenger's seat (AGR-approved*) (eight-way adjustable)
 - Height - Reach - Backrest
 - Seat cushion extension
 - Lumbar adjustment (four-way electrical)
 - Head restraint
- Sliding 60/40 split-folding rear seat back with centre rear seat armrest
- Heated front seats

Seat trim:

- Alcantara seat trim inserts
- Jet black premium leather-effect side bolsters

VX_CRO_31457

*AGR (The Campaign for Healthier Backs) is an independent centre of excellence for ergonomics, based in Germany.

Safety and Security

Standard Safety Features – The following features are standard across the entire Crossland range.

Airbags

- Driver's airbag
- Front passenger's airbag
- Front seat side-impact airbags
- Full-size curtain airbags

Seatbelts

- Inertia-reel lap and diagonal seatbelts for all seats
- Dual seatbelt pretensioners on front seats
- Pretensioners on outer rear seatbelt retractors
- Load limiters on front and outer rear seatbelt retractors
- Smart seatbelt reminder for front and rear seats

Braking

- Hill start assist – Briefly maintains rear brake pressure to stop the vehicle rolling back on an incline

Tyre pressure

- Tyre pressure monitoring system

Child safety

- Deactivation switch for front passenger's front and side-impact airbags
- ISOFIX child seat mountings incorporating top tether anchor points located on outer rear seats (does not include child seat)
- Child-proof locks on rear doors

Pedestrian safety

- Collapsible windscreen wiper system – Designed to reduce pedestrian head injuries
- Upper and lower bumper design – Reduces upper and lower leg injuries

Security

- Electronically protected audio equipment
- Engine deadlock immobiliser
- Visible Vehicle Identification Number (VIN)
- Locking wheel bolts for alloy wheels
- Luggage area cover

Remote control central locking

- Operates on doors, tailgate and fuel filler flap
- Deadlocking
- Central locking activation switch on driver's door



Hill start assist.



ISOFIX child seat mountings.

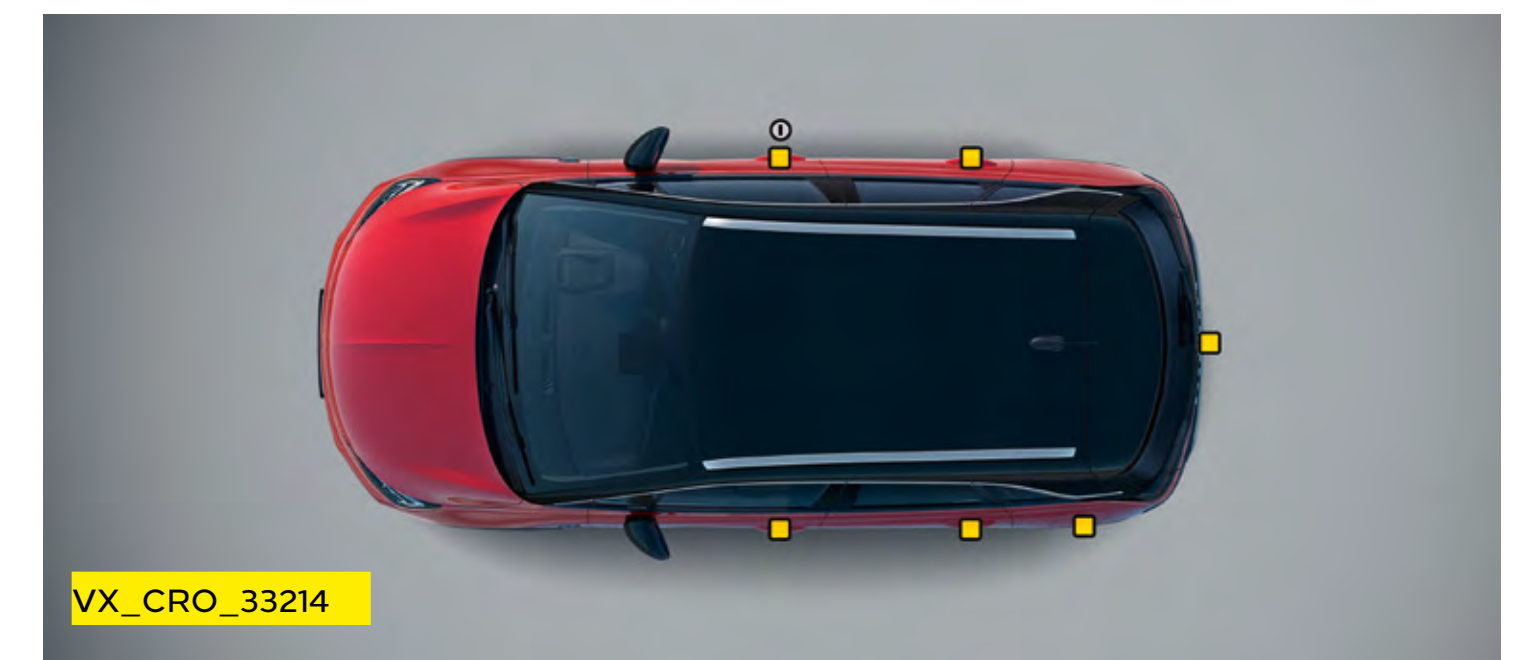

Remote control central locking.

Lighting

Standard Lighting Features – The following features are standard across the entire Crossland range.
Specific features by model are outlined in the separate tabular information.

Exterior Lighting

- LED headlights
- LED side repeat indicators
- Lights-on audible warning – When driver's door is opened an audible warning sounds to alert the lights have been left on

- Rear fog light
- Reversing light
- Hazard warning lights
- Automatic lighting control

Interior Lighting

- Central front courtesy light
- Central rear courtesy lights
- Fade up/fade down

Model Specific Features

	Design	GS Line	Ultimate
Exterior Lighting			
Manual headlight levelling system	●		
Automatic headlight levelling system		●	●
Automatic high beam control with cornering light		●	●
LED daytime running lights		●	●
LED tail lights		●	●
LED front fog lights		●	●
Interior Lighting			
Ambient lighting		●	●

Styling

Standard Features – The following features are standard across the entire Crossland range. Specific features by model are outlined in the separate tabular information.

Exterior Styling

- Body-colour front and rear bumpers
- Body-colour door handles
- Black painted door mirrors
- Integrated tailgate spoiler



Black roof (22T)

Model Specific Features

	Design	GS Line	Ultimate
Exterior Styling			
Chrome-effect Griffin logo, vizzor frame and rear lettering. Black grained skid plates	●		
Black Griffin logo, vizzor frame, rear lettering and skid plates		●	●
Dark-tinted rear side and tailgate windows		●	●
Silver-effect side door mouldings			●
Silver-effect roof rails			●
Roof Colours			
Body-coloured roof	●		
Black roof		●	●
Window Moulding Colours			
Black upper window moulding	●		
Red upper window moulding		●*	
Chrome-effect upper window moulding		●**	●

*Not available with Hot Red and Navy Blue body colours. **Standard with Hot Red and Navy Blue body colours.

Exterior Colours

Jade White (G20)*
Brilliant paint



VX_CRO_33075

Navy Blue (G4B)**
Two-coat metallic paint £600



VX_CRO_33081

Crystal Silver (GAU)†
Two-coat metallic paint £600



VX_CRO_33352

Quartz Grey (G4I)†
Two-coat metallic paint £600



VX_CRO_33076

Moonstone Grey (G4O)†
Two-coat metallic paint £600



VX_CRO_33077

Diamond Black (G7O)†
Two-coat metallic paint £600



VX_CRO_33078

Hot Red (G1R)†
Two-coat premium metallic paint £700





VX_CRO_33079

The colours reproduced may vary slightly from the actual paint colour. As a result they should be used as a guide only. Your Vauxhall Retailer has a comprehensive display of our paint samples.

*Standard exterior paint. **Optional at extra cost including VAT. Not available on GS Line. †Optional at extra cost including VAT.

Wheels and Tyres

	Design	GS Line	Ultimate
 <p>VX_CRO_31466_WQS</p> <p>16-inch diamond-cut bi-colour five twin-spoke alloy wheels</p> <ul style="list-style-type: none"> • 195/60 R 16 Tyres • Emergency tyre inflation kit (in lieu of spare wheel) 	●		
 <p>VX_CRO_31509_PYX</p> <p>17-inch black five twin-spoke alloy wheels</p> <ul style="list-style-type: none"> • 215/50 R 17 tyres • Emergency tyre inflation kit (in lieu of spare wheel) 		●	
 <p>VX_CRO_31465_PZE</p> <p>17-inch diamond-cut bi-colour five twin-spoke alloy wheels</p> <ul style="list-style-type: none"> • 215/50 R 17 tyres • Emergency tyre inflation kit (in lieu of spare wheel) 			●
Provision for spare wheel fitment (spare wheel is Retailer-fit)	£20*	£20*	£20*

*Optional at extra cost including VAT.

Performance, Fuel Economy and Emissions**

	Performance (manufacturer's figures)		Fuel economy mpg (litres/100km)#		CO ₂ emissions g/km#		Vehicle Excise Duty*		BiK rates from - 2022/23 tax year
	Maximum speed (mph)	Acceleration 0-60mph (sec)	Combined Low	Combined High	Combined Low	Combined High	First year rate	Standard rate	
1.2 (83PS)	106	14.0	46.3 (6.1)	48.7 (5.8)	132	139	£230	£165	32%
1.2 (110PS) Turbo	116	10.5	46.3 (6.1)	48.7 (5.8)	129	138	£230	£165	31%
1.2 (130PS) Turbo auto	123	9.9	44.1 (6.4)	46.3 (6.1)	136	143	£230	£165	32%
1.5 (110PS) Turbo D	115	11.4	58.9 (4.8)	62.8 (4.5)	120	126	£190	£165	29%

Weights and Towing Data_{kg}**

	Gross vehicle weight	Maximum towing weights Trailer with brakes (without brakes)
1.2 (83PS)	1690	650 (560)
1.2 (110PS) Turbo	1770	840 (600)
1.2 (130PS) Turbo auto	1835	840 (600)
1.5 (110PS) Turbo D	1820	840 (620)

*Figures shown are for comparison purposes and should only be compared to the fuel consumption and CO₂ values of other cars tested to the same technical standard. The fuel consumption achieved, and CO₂ produced, in real world conditions will depend upon a number of factors including, but not limited to: the accessories fitted (pre and post registration); variations in weather; driving styles and vehicle load. The WLTP (Worldwide Harmonised Light Vehicles Test Procedure) is used to measure fuel consumption and CO₂ figures. The CO₂ figures display a range to reflect the highest value for the highest emitting version with all available options added, through to a minimum value to represent the lowest emitting version in standard specification. *Correct at time of publication. **Provisional data.

Please note: Gross vehicle weight is the total permissible weight of the vehicle including passengers and their luggage. The **maximum roof rack loading** should not exceed 70kg. The **maximum towing weights** are based on the ability of the car, with two occupants of 75kg each, to restart on a 12% gradient, which is approximately 1 in 8.3, at sea level. The permitted trailer load applies up to the specified incline and up to an altitude of 1000 metres above sea level. The permissible gross train weight decreases by 10% for every 1000 metres of additional altitude. At altitudes above 1500 metres, the engine output may drop with a corresponding reduction in towing capability. Any extra weight, such as luggage or additional passengers, should be deducted from the maximum towing weight. With a trailer fully loaded, **maximum noseweight** should not exceed 55kg. Always fit Vauxhall towing attachments and accessories available from your Vauxhall Retailer. They are designed specifically for Vauxhall models and carry a 12-month guarantee. During trailer towing do not exceed a maximum speed of 60mph. This speed limit is also applicable in countries with higher permitted speeds for trailer-vehicle combinations. Pay attention to the local speed limits. For trailers with low driving stability and caravans the use of an oscillation damper is strongly recommended.

Petrol Engines

	1.2 (83PS) with 6-speed manual	1.2 (110PS) Turbo with 6-speed manual	1.2 (130PS) Turbo with 6-speed automatic
Capacity	1199cc	1199cc	1199cc
Maximum power	83PS (61kW) @ 5750rpm	110PS (81kW) @ 5500rpm	130PS (96kW) @ 5500rpm
Maximum torque	118Nm (87lb.ft.) @ 1750rpm	205Nm (151lb.ft.) @ 1750rpm	230Nm (169lb.ft.) @1750rpm
Configuration	3 cylinders, 4 valves per cylinder, double overhead camshafts	3 cylinders, 4 valves per cylinder, double overhead camshafts	3 cylinders, 4 valves per cylinder, double overhead camshafts
Fuel/induction system	Naturally aspirated with Variable Valve Timing. Multi-point sequential electronic fuel injection	Turbocharger. Variable Valve Timing. Direct fuel injection	Turbocharger with intercooler. Multi-point sequential fuel injection
Emission compliance	Euro 6d	Euro 6d	Euro 6d
Service interval	12,500 miles or 1 year (whichever occurs sooner)	12,500 miles or 1 year (whichever occurs sooner)	12,500 miles or 1 year (whichever occurs sooner)

Diesel Engine

	1.5 (110PS) Turbo D with 6-speed manual
Capacity	1499cc
Maximum power	110PS (81kW) @ 3500rpm
Maximum torque	250Nm (184lb.ft.) @ 1750rpm
Configuration	4 cylinders, 4 valves per cylinder, double overhead camshafts
Fuel/induction system	Turbocharger. Direct fuel injection
Emission compliance	Euro 6d
Service interval	20,000 miles or 1 year (whichever occurs sooner)

Specifications

Transmission

Five-speed manual gearbox

Petrol engines: 1.2 (83PS)

Six-speed manual gearbox

Petrol engines: 1.2 (110/130PS) Turbo models

Diesel engines: 1.5 (110PS) Turbo D models

Six-speed automatic transmission

Petrol engines: 1.2 (130PS) Turbo models

Steering

- Speed-sensitive electric power-assisted steering
- Turning circle (wall-to-wall): 11.21m (36.7ft)

Suspension

Front: Independent. Lightweight MacPherson struts with gas-pressure dampers and coil springs. Anti-roll bar.

Rear: Compound crank with coil springs and hydraulic dampers.

Braking and stability

- Switchable Electronic Stability Programme (ESP)
- Anti-lock Braking System (ABS)
- Corner stability control
- Traction control
- Hill start assist
- Engine drag torque control
- Hydraulic brake assist
- Hydraulic brake boost
- Electronic brakeforce distribution

1.2 (83PS)/1.5 (110PS) Turbo D models

Front ventilated discs: 266mm diameter

Rear discs: 249mm diameter

1.2 (110PS) Turbo/1.2 (130PS) Turbo

Front ventilated discs: 283mm diameter

Rear discs: 249mm diameter

Fuel tank capacity

- 45 litres (9.9 gallons)

AdBlue® Tank Capacity

- 14.8 litres (3.2 gallons)

Body

- Aerodynamic drag co-efficient: Cd 0.31

Start/Stop technology

Crossland's Start/Stop system, fitted as standard to all models, offers real benefits by improving fuel economy and reducing CO₂ emissions, particularly in town. It does this by automatically stopping the engine when you come to a standstill, and then restarting as you prepare to move off.

Before automatically stopping the engine a number of system checks are carried out to ensure that it is both safe and practical to do so. To ensure safety, the driver must depress the clutch pedal, shift in to neutral, and then release the clutch pedal. System checks carried out before Auto Stop activates include:

- Start/Stop system is not manually deactivated via the facia button
- Sufficient brake vacuum is available to prevent the car rolling down an incline
- Battery is in good condition and charged
- Outside air temperature and engine temperature are above specified minima
- Electronic climate control (where fitted) is not in maximum heating or maximum cooling mode
- Self-cleaning function of the diesel particulate filter is not active

If all of these conditions are satisfied then the vehicle will Auto Stop.

When you are ready to pull away from standstill, Auto Restart is activated by depressing the clutch pedal.

Whilst at a standstill the vehicle is continually monitored. If necessary, the engine will automatically be restarted. Conditions that would initiate an Auto Restart include:

- Low battery level
- Brake vacuum below specified minimum
- Start/Stop system is manually deactivated
- Stationary for 5.5 minutes

Dimensions and Capacities All measurements in mm (inches) unless stated otherwise.



Loadspace Dimensions	
Maximum length behind rear seats	793 (31.2)
Maximum length rear seats folded	1483 (58.4)
Maximum width	1000 (39.4)
Maximum height	894 (35.2)

Luggage Capacities Litres (cu.ft.)	
Rear seats up (under luggage compartment cover)	410 (14.5)
Rear seats up with optional sliding rear seats in forward-most position	520 (18.4)
Rear seats folded (to roof)	1255 (44.3)

Accessories

Safety	Total (inc. VAT)	Protection	Total (inc. VAT)	Comfort	Total (inc. VAT)	Transport solutions	Total (inc. VAT)
Spare wheel kit with 16-inch emergency wheel and tool kit ¹	£167	Floor mats (set of 4)		USB charger – 2 front and 2 rear ports	£28	Roof base carrier (set of 2 bars) ⁶	
Philips ADR620 dash cam	£109	– Carpet	£44	FlexConnect bracket	£20	– Without roof rails	£183
Front parking sensors ²	£370	– Velour	£55	FlexConnect hook	£37	– With roof rails	£174
Rear parking sensors	£415	– Rubber	£62	FlexConnect coat hanger	£41	Roof carriers (requires base carrier)	
Rear view camera ³	£334	Boot carpet mat	£52	FlexConnect folding table	£102	Roof box – Thule Ocean 80	£164
Side steps	£653	Boot tray ⁵	£74	FlexConnect iPad Mini holder	£127	Roof box – Thule Ocean 200	£374
Child seats ⁴		Vertical cargo net	£293	FlexConnect iPad holder	£106	Roof box – Thule Touring 200	£428
– Group 0 (0-13kg) – Britax Romer Baby Safe	£239	Dog guard	£206	FlexConnect iPad Air holder	£106	Roof box – Thule Touring 700	£492
– ISOFIX Base, Rear-facing for Britax Romer Baby Safe	£251	Front and rear splash guards	£117	FlexConnect Samsung Galaxy 10.1 holder	£127	Roof box – Thule Motion 800	from £426
– Group 2/3 (15-36kg) – Britax Romer KIDFIX 2 R	£317	Style		Privacy shades for rear and side rear windows (set of 4)	£102	Bike carrier – Thule FreeRide 532	£81
– Group 2/3 (15-36kg) – Britax Romer KIDFIX XP	£352	Door sills		Cupholder organisers	£8-10	Bike carrier – Thule Expert 298	£134
– Group 3 (22-36kg) – Booster Seat without Seatback	£76	– Stainless steel	£41	Smoker's kit	£38	Surfboard carrier – Thule 833	£84
Safety Pack – first aid kit, hi-vis vest and warning triangle	£16	– Illuminated kit	£177	Fragrance diffuser	£24	Kayak carrier – Thule Hull-a-Port Pro 837	£234
Warning triangle	£9	Sport pedal covers		Fragrance cartridge (various)	£18	Ski/snowboard carrier	
Hi-vis safety vest – adult	£4	– Manual	£117			– Thule Snow Pack 7324 (4 x pairs)	£147
Hi-vis safety vest – child 3-6 years (42cm)	£4	– Automatic	£117			Ski/snowboard carrier	
Hi-vis safety vest – child 7-12 years (52cm)	£4					– Thule Snow Pack 7326 (6 x pairs)	£265
First aid kit	£15					Towing	
Emergency seat belt cutter and hammer	£19					Tow bar	
Spare bulb kit	£61					– Fixed	from £627
Stretch tow rope	£20					– Detachable	from £502

Please note: Prices shown are fully fitted and painted, where applicable and include VAT. Please check with your local Vauxhall Retailer for details. It is advisable to ensure your insurance policy is adequate to cover additional fitted accessories. Prices correct at time of publication.

¹Vehicle must be ordered with spare wheel fixing option (T7Y) in order to accommodate the spare wheel. ²Can only be fitted with rear parking sensors. ³Only compatible with IOA radio (BYOM2). ⁴Restrictions apply to the use of child seats, please consult your vehicle user manual or Vauxhall Retailer. ⁵Not compatible with spare wheel. ⁶A dedicated T-Track adapter (Thule 697-4 or Thule 697-6) is required for the installation of specific roof boxes, contact your local Vauxhall Retailer for details.

Company Car Driver and Fleet Information

High spec, low P11D

As a business and company car driver, you'll find all of our models are seriously fit for fleet; we're talking very low P11D values, generous standard specification and high-tech engines designed for great fuel economy and low emissions – and that's just to get you started.

To get access to even more spec as standard, simply take a step up in the range – low P11D values will continue to apply.

Drivers and businesses all have unique requirements and by taking advantage of low whole-life costs and low company car driver taxation you can get in the driving seat with the spec to suit.

Benefit in kind company car taxation*

The car benefit charge will be the car's list price (including VAT, options and accessories fitted, delivery to Retailer and number plates, but excluding Vehicle Excise Duty and new vehicle first registration fee) multiplied by the percentage charge for the CO₂ emissions band in which the car falls (see table opposite). Multiply this figure by your personal income tax rate (20%** for Basic Rate, 40%** for Higher Rate) to calculate your annual benefit in kind tax liability.

Generic example:

DIESEL vehicle: 120g/km CO ₂	
On-the-road RRP	£20,225.00
Deduct: Vehicle Excise Duty	-£180.00
New vehicle first registration fee	-£55.00
Effective list price	£19,990.00
Add: Optional two-coat metallic paint	£600.00
List price for tax purposes (P11D value)	£20,590.00
Car benefit charge 2022-23 tax year (29%)	£5,972.00
Benefit in kind tax liability	
Basic Rate (20%) tax payer	£1,194.40
Higher Rate (40%) tax payer	£2,388.80

*Please note this Price Guide provides taxation information as a guide only. Vauxhall does not provide taxation guidance. Drivers should always take professional advice on their own tax position.

**Excludes residents of Scotland.

BiK for Scottish Residents

Effective 6 April 2018 the Scottish Government have introduced their own BiK taxation structure. This only applies to Company Car Drivers that are Scottish taxpayers. HMRC will determine whether or not an individual is a Scottish taxpayer based on where their main place of residence is.

The BiK rates for Scotland are:

- Over £12,570 – £14,732 Starter Rate 19%
- Over £14,732 – £25,688 Basic Rate 20%
- Over £25,688 – £43,662 Intermediate Rate 21%
- Over £43,662 – £150,000 Higher Rate 41%
- Above £150,000 Top Rate 46%

CO ₂ emissions (g/km)	Percentage of cars price to be taxed 2022-23 tax year
Up to 50	14%
51 – 54	15%
55 – 59	16%
60 – 64	17%
65 – 69	18%
70 – 74	19%
75 – 79	20%
80 – 84	21%
85 – 89	22%
90 – 94	23%
95 – 99	24%
100 – 104	25%
105 – 109	26%
110 – 114	27%
115 – 119	28%
120 – 124	29%
125 – 129	30%
130 – 134	31%
135 – 139	32%
140 – 144	33%
145 – 149	34%
150 – 154	35%
155 – 159	36%
160 – 164	37%
165 – 169	37%
170+	37%

Fleet Toolbox

Discover the facts in our online Toolbox for both Company Car Drivers and Fleet Decision Makers. The Fleet Toolbox has a host of useful calculators, comparators, interactive listings and information.

Search Vauxhall Fleet Tools or click the link below:

[Vauxhall Fleet Tool Box](#)

Contact Vauxhall Fleet

Please contact one of our dedicated sales teams who will be happy to help with your particular enquiry.

Company Car Drivers

Call: 0345 111 2020

Email: company-car@vauxhallinfo.co.uk

Telephone lines are open

– Monday to Friday 8:00am–9:00pm

– Saturday and Sunday 9:00am–6:00pm

Fleet Decision Makers

Depending on the size of your fleet of vehicles, we have a dedicated team to handle your enquiries. The lines are open Monday to Friday excluding Bank Holidays.

1-24 vehicles

Call: 0845 076 2254 (8:30am–5:00pm)

25+ vehicles

Call: 0330 587 8222 (8:30am–5:00pm)

Email: vauxhallfleet@vauxhall.co.uk

Special Vehicles (Police, Fire and Ambulance)

Call: 01582 409999 (8:30am–5:00pm)

Email: vauxhallspecialvehicles@vauxhall.co.uk

To calculate your own personal liability, search:

Vauxhall BiK, or click the link below:

[Vauxhall BiK Tool](#)

Further Information

On-the-road prices

To eliminate uncertainty about hidden costs when buying a new car, Vauxhall publishes on-the-road recommended retail prices (RRP) and these are shown in the pricing tables within this price guide. These prices include VAT, number plates and delivery to Retailer of £700.00 (including £116.67 VAT), 12 months' Government Vehicle Excise Duty (see opposite for details) and the DVLA new vehicle first registration fee of £55.00.*

Please note: The on-the-road recommended retail price (RRP) does not include fuel supplied by the Retailer, motor insurance or any other goods or services supplied by agreement between the Retailer and the customer.

Price protection

Order a new Vauxhall for build in the current model year (as confirmed by your Retailer) for delivery no more than three months in advance and the price you are quoted is the price you pay. This is irrespective of any subsequent price rises between placing your order and delivery of your new car, but you must take delivery as soon as the car is available.

In the event of an accident

Vauxhall Accident Management helps keep you mobile following an accident. Benefits include vehicle recovery, Vauxhall-approved repairs and contacting your insurer. For more details, visit vauxhall.co.uk/AccidentManagement

Free2Move Lease

Whether you're a big company or a small business looking for vehicle financing, Free2Move Lease, our business finance specialists, can deliver exactly what you need.

Free2Move Lease is one of the UK's largest leasing companies and is also a member of the British Vehicle Rental and Leasing Association (BVRLA).

With over 60,000 vehicles in the Free2Move Lease portfolio, Free2Move Lease is able to offer competitive vehicle solutions. In addition, Free2Move Lease also offer innovative connected management of servicing and maintenance.

For further information, please contact your local Vauxhall Retailer or visit vauxhall.co.uk/offers-finance/business-leasing.html

Vehicle Excise Duty

The amount of Vehicle Excise Duty (road fund licence) payable on new cars varies depending on the level of carbon dioxide (CO₂) emissions produced by the vehicle. CO₂ emissions are measured in grams per kilometre (g/km) travelled and divided into 13 charging bands shown in the table opposite.

A 'first year rate' of Vehicle Excise Duty is payable on all new cars and in subsequent years the amount payable reverts to the 'standard rate'. From 1 April 2017 the breakpoints for each of these bands have been revised. Also, for vehicles with a list price over £40,000, including factory-fitted options, an additional £335 is payable for the first five years of standard rate payments.

Vehicle Excise Duty*

Band	CO ₂ emissions in grams per kilometre	First year rate Petrol/Diesel	Standard rate Petrol/Diesel
A	0	£0	£0
B	1 – 50	£10	£165
C	51 – 75	£25	£165
D	76 – 90	£120	£165
E	91 – 100	£150	£165
F	101 – 110	£170	£165
G	111 – 130	£190	£165
H	131 – 150	£230	£165
I	151 – 170	£585	£165
J	171 – 190	£945	£165
K	191 – 225	£1,420	£165
L	226 – 255	£2,015	£165
M	Over 255	£2,365	£165

*Correct at time of issue.

Further Information

Customer Care Commitment

For added peace of mind, Vauxhall has an innovative Customer Care Commitment that offers the following:

- Three-year vehicle warranty consisting of a one-year/unlimited mileage manufacturer's warranty and a second and third year manufacturer's warranty with a 60,000 miles limitation
- Vauxhall Assistance for 12 months from first registration
- Six years' body panel anti-perforation warranty

Please note: Warranty is only available on vehicles sourced from Vauxhall Motors Limited. Terms and conditions apply – please see your Vauxhall Retailer for details.

Vauxhall Assistance

Vauxhall Assistance is provided automatically with every new Vauxhall for 12 months from first registration and covers everything from accident assistance, roadside recovery and 'at home' service to flat tyres. Even more reason for you to stay calm and let us take care of everything should the need arise. With Vauxhall Assistance help is literally just a free* phone call away, 24 hours a day, 365 days a year!

Protecting the environment

Vauxhall's commitment to the environment is demonstrated by our products' many environmental awards. For even more information on Vauxhall's efforts to achieve an environmentally sustainable future, and how to dispose of your end-of-life vehicle, see vauxhall.co.uk/recycling

Vauxhall Care

This all-inclusive service package is available on Vauxhalls under 10 months old (from date of first registration).

This package offers complete peace of mind for the first 3 years of your Vauxhall's life with fixed monthly payments for the plan duration.

- **3 years' Vauxhall servicing** – covers first, second and third annual services. Including a brake-fluid change in the second service
- **2 years' Vauxhall Roadside Assistance** – first year from us
- **First years' MOT**** – free of charge by your local Vauxhall Retailer

For full terms and conditions and to sign up, visit: vauxhall.co.uk/vauxhallcare

Vauxhall Service Club

Vauxhall Service Club is available for all Vauxhall owners, and it's free to join. Members benefit from the following:

- 15% off Vauxhall Approved Accessories
- Vauxhall's aged 2-3 Years = 15% off parts and labour
- Vauxhall's aged over 3 Years = 25% off parts and labour
- Half price MOT's (NI excluded)
- Free pre-MOT test inspection (NI only)
- Fixed price AdBlue® Refills
 - Car = £14.99
 - Van = £24.99
- Access to the Vauxhall Accident Management Programme
- Online service booking available 24/7 with servicing appointments available within 3 days – [Book Online](#)
- Collection and delivery/onward mobility options
- Complimentary 'Wash and Vac' with all routine services†
- Vauxhall trained technicians
- Genuine Vauxhall parts
- Minimum 12 months warranty on parts and labour
- Regular newsletters with exclusive offers, discounts and competitions

Terms and conditions apply. To join visit: vauxhall.co.uk/serviceclub

Vauxhall Insurance with added reassurance

Comprehensive cover – Summary of benefits

- Competitive premiums
- Repairs by a Vauxhall-trained technician
- Genuine Vauxhall parts, guaranteed for five years when we repair your car within our Approved Repairer Network
- Free courtesy car as standard when using an Approved Repairer††
- 24 hour claims helpline
- Personal Accident benefit
- Cover for audio equipment
- Windscreen cover

Call for a quote on **0330 678 1130**‡

For more product information

For further information on the Vauxhall range or location of your nearest Vauxhall Retailer please call **0345 600 1500**. Alternatively, details can be found on our website at vauxhall.co.uk

For more information call **0345 600 1500**

For Fleet enquiries call **0330 587 8222**

Discover the full Vauxhall range at **[vauxhall.co.uk](https://www.vauxhall.co.uk)**

Join us online

The invoice price, including delivery to Retailer, factory-fitted options, accessories fitted by the Retailer and number plates, is subject to VAT. Some feature descriptions in this guide may refer to, and some illustrations may show, optional equipment not included in the standard delivery. The information contained in this guide was accurate at the time of publication. We reserve the right to make changes in design and equipment. Please note that Vauxhall Retailers are not the agents of Vauxhall Motors Limited and are not authorised to bind Vauxhall Motors Limited by any specific or implied undertaking or representation. It is advisable to ensure that your motor insurance policy provides adequate cover for additional fitted options and accessories. The colours in this guide are only approximate actual colours. Illustrated optional equipment is available at extra charge. Availability, technical features and equipment provided on our vehicles can vary by model. For precise information on the equipment provided on our vehicles, please contact your local Vauxhall Retailer.

VAUXHALL

Price and Specification Guide
6 April 2022 | Model Year 2022A



New Grandland

Including new Plug-in HYBRID-e models

Contents

To find the information you want use the links below to navigate around the guide:

[Pure Technology](#)

[Choose Your Trim Level](#)

[Range Highlights](#)

[Models](#)

[Prices](#)

[PureSense](#)

[PureConnect](#)

[Comfort and Convenience](#)

[Safety and Lighting](#)

[Styling](#)

[Exterior Colours](#)

[Wheels and Tyres](#)

[Specifications](#)

[Dimensions and Capacities](#)

[Accessories](#)

[Company Car Information](#)

[Further Information](#)

Pure Technology

The New Grandland is an all-round class-leading car, with an advanced plug-in hybrid option and intuitive technology. Like adaptive IntelliLux Pixel Lights with 84 elements per headlamp, state-of-the-art driver assistance systems and the new fully digital 'Pure Panel' dashboard.

Vauxhall Pure Technology

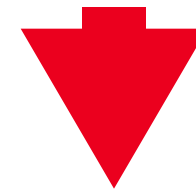

Vauxhall PureEnergy

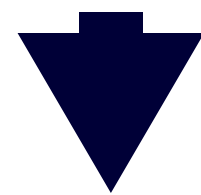

New Grandland Plug-in HYBRID-e.

- Plug in Hybrid
- Total cost of ownership equal to Petrol and Diesel models
 - Up to 39 miles electric-only range
- Smooth 8-speed electrified automatic transmission

Vauxhall PureSense

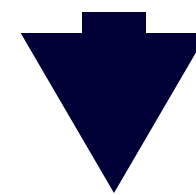

Intelligent automotive technology that's designed to give you unparalleled command and control of your every journey.

- IntelliLux pixel matrix lights
 - Night vision
- Highway integration assist (auto only)
 - Front camera safety system
 - Side blind spot alert
 - Driver drowsiness alert
- 360° panoramic parking camera
 - Advanced park assist

Vauxhall PureConnect

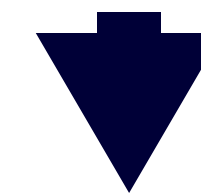

Intuitive connectivity that makes it simple to stay in touch, informed and entertained throughout day.

- Pure Panel technology
- Live satellite navigation capability
 - Smartphone projection
 - Wireless phone charging
 - Vauxhall Connect (Plug-in HYBRID-e models only)

Choose Your Trim Level

Design



Design is New Grandland's entry level trim which has a high level of specification as standard including the 7-inch colour touchscreen with smartphone projection, 17-inch alloy wheels, dual-zone climate control and more.

GS Line



The sporty GS Line provides an aggressive look with a black roof and door mirrors combined with 18-inch high gloss black alloy wheels, dark tinted rear windows and high gloss black exterior detailing.

Also available as a Plug-in HYBRID-e model.

Ultimate



Ultimate builds on the already impressive GS Line spec adding a 360° panoramic parking camera, Alcantara seats, high gloss black badging and more.

Also available as a Plug-in HYBRID-e model.

New Grandland Plug-in HYBRID-e Range Highlights

GS Line

Standard features include:

PureSense

- LED headlights, tail lights and daytime running lights
- High beam assist
- Automatic lighting control
- Electronic parking brake
- Lane departure warning with lane keep assist
- Speed sign recognition
- Driver drowsiness alert
- Forward collision alert
- Automatic emergency braking
- Highway integration assist (auto only)
 - Lane positioning assistant
 - Adaptive cruise control
- Six airbags
- Hill start assist
- ISOFIX child seat fixings on front passenger seat and outer rear seats
- 180° rear-view parking camera

PureConnect

- Multimedia Pure Panel Navigation system
 - 10-inch colour touchscreen
 - 12-inch digital instrument cluster
 - Satellite navigation
 - AM/FM/DAB digital radio
 - Bluetooth®
 - Apple CarPlay/Android Auto™
 - Front USB connection
- Six speakers
- Vauxhall Connect

Comfort and Convenience

- Dual-zone electronic climate control with pre-conditioning
- Flat-bottomed leather-covered steering wheel
- Steering wheel audio/phone/cruise controls
- 60/40 split-folding rear seat backs
- Rain-sensitive windscreen wipers
- Electrically operated front and rear windows
- Electrically adjustable/heated power folding door mirrors
- Soundproofed insulated windscreen
- Driver's ergonomic active sports-style seat (AGR approved*)
- Front passenger's sports-style seat
- Driver's armrest
- Centre rear seat armrest with load through facility
- Frameless automatic anti-dazzle rear-view mirror with LED spotlight
- Remote control security alarm system

Styling

- 18-inch 5-twin spoke high gloss black alloy wheels
- Black roof with high gloss black roof rails
- High gloss black exterior detailing
- Dark-tinted rear windows

Ultimate

Features over GS Line models:

PureSense

- IntelliLux adaptive LED® pixel headlights
- LED front fog lights
- 360° panoramic parking camera
- Side blind spot alert
- Advanced park assist
- Front and rear parking distance sensors

PureConnect

- Wireless charger for mobile devices

Comfort and Convenience

- Storage pocket on front seat backs
- Ergonomic active heated sports-style front seats (AGR approved*)
- 12-volt accessory socket in luggage compartment
- 230-volt accessory socket in rear
- Power operated tailgate with foot sensor
- Alcantara interior seat trim
- Heated steering wheel
- Keyless entry and start

Styling

- 19-inch diamond-cut bi-colour alloy wheels
- Alloy-effect protective front and rear skid plates

New Grandland Range Highlights

Design

Standard features include:

PureSense

- LED headlights, tail lights and daytime running lights
- High beam assist
- Automatic lighting control
- Electronic parking brake
- Lane departure warning with lane keep assist
- Speed sign recognition
- Driver drowsiness alert
- Automatic emergency braking
- Six airbags
- Cruise control with speed limiter
- Hill start assist
- ISOFIX child seat fixings on front passenger seat and outer rear seats
- 180° rear-view parking camera

PureConnect

- Multimedia infotainment system
 - 7-inch colour touchscreen
 - 7-inch digital instrument cluster
 - AM/FM/DAB digital radio
 - Bluetooth®
 - Apple CarPlay/Android Auto™
 - Front USB connection
- Six speakers

Comfort and Convenience

- Dual-zone electronic climate control
- Flat-bottomed leather-covered steering wheel
- Steering wheel audio/phone/cruise controls
- 60/40 split-folding rear seat backs
- Rain-sensitive windscreen wipers
- Electrically operated front and rear windows
- Electrically adjustable/heated power folding door mirrors
- Soundproofed insulated windscreen
- Driver's armrest
- Remote control security alarm system

Styling

- 17-inch 5-twin spoke silver-effect alloy wheels

GS Line

Features over Design models:

PureConnect

- Multimedia Pure Panel Navigation system
 - 10-inch colour touchscreen
 - 12-inch digital instrument cluster
 - Satellite navigation

Comfort and Convenience

- Driver's ergonomic active sports-style seat (AGR approved*)
- Front passenger's sports-style seat
- Centre rear seat armrest
- Automatic anti-dazzle rear-view mirror

Styling

- 18-inch 5-twin spoke high gloss black alloy wheels
- Black roof with high gloss black roof rails
- High gloss black exterior detailing
- Dark-tinted rear windows
- Alloy sports pedals (auto models only)

Ultimate

Features over GS Line models:

PureSense

- IntelliLux adaptive LED® pixel headlights
- LED front fog lights
- 360° panoramic parking camera
- Side blind spot alert
- Advanced park assist
- Highway integration assist (auto only)
 - Lane positioning assistant
 - Adaptive cruise control
- Front and rear parking distance sensors

PureConnect

- Wireless charger for mobile devices

Comfort and Convenience

- Storage pocket on front seat backs
- Ergonomic active heated sports-style front seats (AGR approved*)
- Centre rear seat armrest with load through facility
- 12-volt accessory socket in luggage compartment
- 230-volt accessory socket in rear
- Power operated tailgate with foot sensor
- Alcantara interior seat trim
- Heated steering wheel
- Heated windscreen
- Keyless entry and start

Styling

- 19-inch diamond-cut bi-colour alloy wheels
- Alloy-effect protective front and rear skid plates

New Grandland Plug-in HYBRID-e GS Line

VX_GRA_PHEV_33117



GS Line

OTR from £34,570

PureSense

- LED headlights, tail lights and daytime running lights
- High beam assist
- Automatic lighting control
- Electronic parking brake
- Lane departure warning with lane keep assist
- Speed sign recognition
- Driver drowsiness alert
- Forward collision alert
- Automatic emergency braking
- Highway integration assist (auto only)
 - Lane positioning assistant
 - Adaptive cruise control
- Six airbags
- Hill start assist
- ISOFIX child seat fixings on front passenger seat and outer rear seats
- 180° rear-view parking camera

PureConnect

- Multimedia Pure Panel Navigation system
 - 10-inch colour touchscreen
 - 12-inch digital instrument cluster
 - Satellite navigation
 - AM/FM/DAB digital radio
 - Bluetooth®
 - Apple CarPlay/Android Auto™
 - Front USB connection
- Six speakers
- Vauxhall Connect

Comfort and Convenience

- Dual-zone electronic climate control with pre-conditioning
- Flat-bottomed leather-covered steering wheel
- Steering wheel audio/phone/cruise controls
- 60/40 split-folding rear seat backs
- Rain-sensitive windscreen wipers
- Electrically operated front and rear windows
- Electrically adjustable/heated power folding door mirrors
- Soundproofed insulated windscreen
- Driver's ergonomic active sports-style seat (AGR approved*)
- Front passenger's sports-style seat
- Driver's armrest
- Centre rear seat armrest with load through facility
- Frameless automatic anti-dazzle rear-view mirror with LED spotlight
- Remote control security alarm system

Styling

- 18-inch 5-twin spoke high gloss black alloy wheels
- High gloss black front and rear badging
- High gloss black protective front and rear skid plates
- Carbon Black protective wheel arches and lower door cladding
- Black roof with high gloss black roof rails
- High gloss black exterior detailing
- Dark-tinted rear windows

New Grandland Plug-in HYBRID-e Ultimate

VX_GRA_PHEV_33121



Ultimate

OTR from £38,125

PureSense

- IntelliLux adaptive LED® pixel headlights
- LED front fog lights, tail lights and daytime running lights
- High beam assist
- Automatic lighting control
- Electronic parking brake
- Front and rear parking distance sensors
- Lane departure warning with lane keep assist
- Speed sign recognition
- Driver drowsiness alert
- Forward collision alert
- Automatic emergency braking
- Highway integration assist (auto only)
 - Lane positioning assistant
 - Adaptive cruise control
- Six airbags
- Hill start assist
- ISOFIX child seat fixings on front passenger seat and outer rear seats
- 360° panoramic parking camera
- Side blind spot alert
- Advanced park assist

PureConnect

- Multimedia Pure Panel Navigation system
 - 10-inch colour touchscreen
 - 12-inch digital instrument cluster
 - Satellite navigation
 - AM/FM/DAB digital radio
 - Bluetooth®
 - Apple CarPlay/Android Auto™
 - Front USB connection
- Six speakers
- Vauxhall Connect
- Wireless charger for mobile devices

Comfort and Convenience

- Dual-zone electronic climate control with pre-conditioning
- Heated flat-bottomed leather-covered steering wheel
- Steering wheel audio/phone/cruise controls
- 60/40 split-folding rear seat backs
- Rain-sensitive windscreen wipers
- Electrically operated front and rear windows
- Electrically adjustable/heated power folding door mirrors
- Soundproofed insulated windscreen
- Driver's ergonomic active sports-style seat (AGR approved*)
- Front passenger's sports-style seat
- Driver's armrest • Centre rear seat armrest with load through facility
- Frameless automatic anti-dazzle rear-view mirror with LED spotlight
- Remote control security alarm system
- Storage pocket on front seat backs
- Ergonomic active heated sports-style front seats (AGR approved*)
- 12-volt accessory socket in luggage compartment
- 230-volt accessory socket in rear
- Power operated tailgate with foot sensor
- Alcantara interior seat trim
- Keyless entry and start

Styling

- 19-inch diamond-cut bi-colour alloy wheels
- Black roof with high gloss black roof rails
- High gloss black exterior detailing
- High gloss black front and rear badging
- Body colour protective wheel arches and lower door cladding
- Dark-tinted rear windows
- Alloy-effect protective front/rear skid plates

New Grandland Design

VX_GRA_33112



Design

OTR from £26,720

PureSense

- LED headlights, tail lights and daytime running lights
- High beam assist
- Automatic lighting control
- Electronic parking brake
- Lane departure warning with lane keep assist
- Speed sign recognition
- Driver drowsiness alert
- Automatic emergency braking
- Six airbags
- Cruise control with speed limiter
- Hill start assist
- ISOFIX child seat fixings on front passenger seat and outer rear seats
- 180° rear-view parking camera

PureConnect

- Multimedia infotainment system
 - 7-inch colour touchscreen
 - 7-inch digital instrument cluster
 - AM/FM/DAB digital radio
 - Bluetooth®
 - Apple CarPlay/Android Auto™
 - Front USB connection
- Six speakers

Comfort and Convenience

- Dual-zone electronic climate control
- Flat-bottomed leather-covered steering wheel
- Steering wheel audio/phone/cruise controls
- 60/40 split-folding rear seat backs
- Rain-sensitive windscreen wipers
- Electrically operated front and rear windows
- Electrically adjustable/heated power folding door mirrors
- Soundproofed insulated windscreen
- Driver's armrest
- Remote control security alarm system

Styling

- 17-inch 5-twin spoke silver-effect alloy wheels

Effective 6 April 2022

New Grandland Model Year 2022A

New Grandland GS Line

VX_GRA_33114



GS Line OTR from £28,980

PureSense

- LED headlights, tail lights and daytime running lights
- High beam assist
- Automatic lighting control
- Electronic parking brake
- Lane departure warning with lane keep assist
- Speed sign recognition
- Driver drowsiness alert
- Automatic emergency braking
- Six airbags
- Cruise control with speed limiter
- Hill start assist
- ISOFIX child seat fixings on front passenger seat and outer rear seats
- 180° rear-view parking camera

PureConnect

- Multimedia Pure Panel Navigation system
 - 10-inch colour touchscreen
 - 12-inch digital instrument cluster
 - Satellite navigation
 - AM/FM/DAB digital radio
 - Bluetooth®
 - Apple CarPlay/Android Auto™
 - Front USB connection
- Six speakers

Comfort and Convenience

- Dual-zone electronic climate control
- Flat-bottomed leather-covered steering wheel
- Steering wheel audio/phone/cruise controls
- 60/40 split-folding rear seat backs
- Rain-sensitive windscreen wipers
- Electrically operated front and rear windows
- Electrically adjustable/heated power folding door mirrors
- Soundproofed insulated windscreen
- Driver's ergonomic active sports-style seat (AGR approved*)
- Front passenger's sports-style seat
- Driver's armrest
- Centre rear seat armrest
- Automatic anti-dazzle rear-view mirror
- Remote control security alarm system

Styling

- 18-inch 5-twin spoke high gloss black alloy wheels
- Black roof with high gloss black roof rails
- High gloss black exterior detailing
- High gloss black front and rear badging
- High gloss black protective front and rear skid plates
- Carbon Black protective wheel arches and lower door cladding
- Dark-tinted rear windows
- Alloy sports pedals (auto models only)

This vehicle is covered by our Price Protection Guarantee. See 'Further Information' page for details.

*AGR (The Campaign for Healthier Backs) is an independent centre of excellence for ergonomics, based in Germany.

New Grandland Ultimate

VX_GRA_32069



Ultimate OTR from £32,480

PureSense

- IntelliLux adaptive LED® pixel headlights
- LED front fog lights, tail lights and daytime running lights
- High beam assist
- Automatic lighting control
- Electronic parking brake
- Front and rear parking distance sensors
- Lane departure warning with lane keep assist
- Speed sign recognition
- Driver drowsiness alert
- Automatic emergency braking
- Highway integration assist (auto only)
 - Lane positioning assistant
 - Adaptive cruise control
- Six airbags
- Hill start assist
- ISOFIX child seat fixings on front passenger seat and outer rear seats
- 360° panoramic parking camera
- Side blind spot alert
- Advanced park assist

PureConnect

- Multimedia Pure Panel Navigation system
 - 10-inch colour touchscreen
 - 12-inch digital instrument cluster
 - Satellite navigation
 - AM/FM/DAB digital radio
 - Bluetooth®
 - Apple CarPlay/Android Auto™
 - Front USB connection
- Six speakers
- Wireless charger for mobile devices

Comfort and Convenience

- Dual-zone electronic climate control
- Heated flat-bottomed leather-covered steering wheel
- Steering wheel audio/phone/cruise controls
- 60/40 split-folding rear seat backs
- Rain-sensitive windscreen wipers
- Electrically operated front and rear windows
- Electrically adjustable/heated power folding door mirrors
- Soundproofed insulated windscreen
- Ergonomic active heated sports-style front seats (AGR approved*)
- Front passenger's sports-style seat
- Driver's armrest • Centre rear seat armrest with load through facility
- Automatic anti-dazzle rear-view mirror
- Remote control security alarm system
- Storage pocket on front seat backs
- 12-volt accessory socket in luggage compartment
- 230-volt accessory socket in rear
- Power operated tailgate with foot sensor
- Alcantara interior seat trim
- Heated windscreen
- Keyless entry and start

Styling

- 19-inch diamond-cut bi-colour alloy wheels
- Black roof with high gloss black roof rails
- High gloss black exterior detailing
- High gloss black front and rear badging
- Body colour protective wheel arches and lower door cladding
- Dark-tinted rear windows
- Alloy sports pedals (auto models only)
- Alloy-effect protective front/rear skid plates

This vehicle is covered by our Price Protection Guarantee. See 'Further Information' page for details.

Effective 6 April 2022

New Grandland Model Year 2022A

New Grandland Plug-in HYBRID-e Prices

	Pack Code	Fuel Type	Price (£)	VAT (£)	Total (£)	On-the-road RRP (£)	Financial Year 2022/23 BiK 20% (£)	WLTP Combined CO ₂ (g/km)* - pack code	Insurance groups
GS Line									
1.6 (225PS) Turbo/Electric auto	2B75 ID81	Petrol/Electric	28,179.17	5,635.83	33,815.00	34,570.00	69.02	31	23E
Ultimate									
1.6 (225PS) Turbo/Electric auto	2V75 ID81	Petrol/Electric	31,141.67	6,228.33	37,370.00	38,125.00	76.13	31	tba

WLTP Combined CO₂ (g/km) figures are based on a configured vehicle as per pack code for UK with no options fitted.

*Provisional fuel consumption and CO₂ figures are determined according to the WLTP test cycle. CO₂ figures, BiK values and RRP pricing shown above are for a standard vehicle without any additional optional equipment. CO₂ figures are used to calculate Vehicle Excise Duty (VED) for the first registration of the vehicle and BiK. The addition of optional extras could increase the certified CO₂ emission output. This in turn may affect the amount of VED payable upon registration, and, for company car drivers, the P11D value and the amount of Benefit in Kind (BiK) tax payable. Figures shown are for comparison purposes and should only be compared to the fuel consumption and CO₂ values of other cars tested to the same technical standard. The fuel consumption achieved, and CO₂ produced, in real world conditions will depend upon a number of factors including, but not limited to: the accessories fitted (pre and post registration); variations in weather; driving styles and vehicle load. The WLTP (Worldwide Harmonised Light Vehicles Test Procedure) is used to measure fuel consumption and CO₂ figures. Full data relating to WLTP test cycles can be found at: www.vauxhall.co.uk/wltp

Please note: On-the-road recommended retail prices (RRP) include number plates and delivery to Retailer of £700.00 (inc. £116.67 VAT), 12 months' Vehicle Excise Duty and new vehicle first registration fee of £55.00. Excludes fuel and insurance. Company Car Benefit in Kind (BiK) rates are monthly based on the standard paint price.

New Grandland Prices

	Pack Code	Fuel Type	Price (£)	VAT (£)	Total (£)	On-the-road RRP (£)	Financial Year 2022/23 BiK 20% (£)	WLTP Combined CO ₂ (g/km) [#] – pack code	Insurance groups
Design									
1.2 (130PS) Turbo	2C75 EP61	Petrol	21,445.84	4,289.17	25,735.00	26,720.00	140.98	139	15E
1.2 (130PS) Turbo auto	2C75 EF81	Petrol	22,695.84	4,539.17	27,235.00	28,220.00	153.63	144	15E
1.5 (130PS) Turbo D auto	2C75 HE81	Diesel	23,529.17	4,705.83	28,235.00	29,220.00	149.48	133	16E
GS Line									
1.2 (130PS) Turbo	2L75 EP61	Petrol	23,329.17	4,665.83	27,995.00	28,980.00	157.82	140	15E
1.2 (130PS) Turbo auto	2L75 EF81	Petrol	24,579.17	4,915.83	29,495.00	30,480.00	171.10	145	16E
1.5 (130PS) Turbo D auto	2L75 HE81	Diesel	25,412.50	5,082.50	30,495.00	31,480.00	161.17	134	16E
Ultimate									
1.2 (130PS) Turbo	2U75 EP61	Petrol	26,245.84	5,249.17	31,495.00	32,480.00	177.07	141	17E
1.2 (130PS) Turbo auto	2U75 EF81	Petrol	27,620.84	5,524.17	33,145.00	34,130.00	191.78	146	tba
1.5 (130PS) Turbo D auto	2U75 HE81	Diesel	28,454.17	5,690.83	34,145.00	35,130.00	185.83	135	tba

Grandland's petrol and diesel engines meet the Real Driving Emissions Step 2 (RDE2) standards.

WLTP Combined CO₂ (g/km) figures are based on a configured vehicle as per pack code for UK with no options fitted.

[#]Provisional fuel consumption and CO₂ figures are determined according to the WLTP test cycle. CO₂ figures, BiK values and RRP pricing shown above are for a standard vehicle without any additional optional equipment. CO₂ figures are used to calculate Vehicle Excise Duty (VED) for the first registration of the vehicle and BiK. The addition of optional extras could increase the certified CO₂ emission output. This in turn may affect the amount of VED payable upon registration, and, for company car drivers, the P11D value and the amount of Benefit in Kind (BiK) tax payable. Figures shown are for comparison purposes and should only be compared to the fuel consumption and CO₂ values of other cars tested to the same technical standard. The fuel consumption achieved, and CO₂ produced, in real world conditions will depend upon a number of factors including, but not limited to: the accessories fitted (pre and post registration); variations in weather; driving styles and vehicle load. The WLTP (Worldwide Harmonised Light Vehicles Test Procedure) is used to measure fuel consumption and CO₂ figures. Full data relating to WLTP test cycles can be found at: www.vauxhall.co.uk/wltp

Please note: On-the-road recommended retail prices (RRP) include number plates and delivery to Retailer of £700.00 (inc. £116.67 VAT), 12 months' Vehicle Excise Duty and new vehicle first registration fee of £55.00. Excludes fuel and insurance. Company Car Benefit in Kind (BiK) rates are monthly based on the standard paint price.

PureSense

Standard Driver Assistance Features – The following features are standard across the entire New Grandland range. Specific features by model are outlined in the separate tabular information.

Cruise control with speed limiter

With steering wheel mounted controls. Enables you to maintain a constant speed, making it ideal for economical motorway driving.

Lane departure warning with lane keep assist

If the driver has not actively steered or signalled, the lane departure warning system warns when the car moves outside of lane markings at speeds above 37mph.

- Warning light in instrument cluster
- Audible warning
- Facia on/off switch

Speed sign recognition

Detects and then displays speed limits, reducing uncertainty and the risk of speeding.

- Recognises different speed signs, including temporary speed restrictions
- Displays reminder in the instrument cluster
- On models with Sat Nav, where the front camera system is unable to detect any speed signs the speed limit stored in the navigation database will be displayed

Driver drowsiness alert

The system monitors driving time and driving behaviour to help prevent accidents caused by tiredness.

Automatic emergency braking

Monitors the traffic situation in front of the vehicle to detect mobile and fixed cars. The system first warns you through a series of visual and audible alerts and should you not react quickly enough, will automatically brake the vehicle to avoid or mitigate the impact of front-end collisions.

Please note, Vauxhall driver assistance systems are intended to support the driver within the system-imminent limitations. The driver remains responsible for the driving task at all times.

Model Specific Features/Options

	Plug-in HYBRID-e models		Design	GS Line	
	GS Line	Ultimate		GS Line	Ultimate
Driver Assistance					
Night vision		£1,300*			£1,300*
180° rear-view parking camera	●		●	●	
360° panoramic parking camera		●			●
Front and rear parking distance sensors		●			●
Advanced park assist		●			●
Side blind spot alert		●			●
Highway integration assist (auto only) – Lane positioning assistant/ Adaptive cruise control	●	●			●
Forward collision alert	●	●			
6.6kW on-board charger (1 phase) – halves charging time when charging with a 7kW wallbox (see Plug-in HYBRID-e Specifications for further details)	£500*	£500*			

*Optional at extra cost including VAT.

PureConnect

Standard Features – The following features are standard across the entire New Grandland range.

Pure Panel Digital Display

Pure Panel technology makes driving more intuitive, with a flowing design that presents the information you need. With up to 10-inch infotainment touchscreen and 12-inch digital instrument cluster right in front of you, you can stay focused on the road ahead.

EV information display

- Powerflow display – Informs drivers on the current state of charge and what is being used as the power source, petrol or electric
- Charge display – displays an image of the charge port with the corresponding LED charge indication lights
- e-Save – enables the driver to determine how much battery energy needs to be conserved to ensure that the vehicle reaches its destination when in a zero emission zone
There are three options:
– 6 mile/12 mile range reserve/Maximum reserve
- Statistics – The Statistics display the average consumption data over a period of time using colour coded graphs
- **Green:** Energy recovered by braking phases and partial recharging by the petrol engine (kWh/mile)
- **Blue:** Energy consumed by the vehicle directly by the battery (kWh/mile)
- **Orange:** Fuel consumption (mpg)

Digital instrumentation

- Digital speedometer and rev counter
- Satellite Navigation display
- Digital fuel gauge with low fuel level warning light
- Digital water temperature gauge with warning light
- Shift-up/down indication light – Indicates when to change gear for optimum fuel economy

Driver information display

(centrally located in digital instrument cluster)

- Total mileage • Service-due indicator
- Oil life • Tyre pressure monitoring system

Multi-function trip computer

(displayed on digital instrument cluster)

- Trip mileage
- Vehicle range based on remaining fuel
- Average speed • Average fuel economy
- Instantaneous fuel economy • Driving time

Digital central facia display

- Audio information
- Digital clock with automatic RDS time adjustment
- Outside air temperature with ice warning function



VX_GRA_32118



VX_GRA_32107

Model Specific Features

	Plug-in HYBRID-e models		Design	GS Line	Ultimate
	GS Line	Ultimate			
Driver Information					
7-inch digital instrument cluster (centrally located in instrument panel)			●		
12-inch digital instrument cluster (centrally located in instrument panel)	●	●		●	●

Standard Features – Vauxhall Connect* is the new way to stay connected while on the road. Smart technology systems and related services keep our drivers safe and provide an exciting, efficient yet safe trip. Activating Vauxhall Connected Services is easy, just visit Vauxhall Connect Store or download MyVauxhall app.

Peace of mind

- Emergency call (SOS e-call)
- Breakdown call (b-call)
- Vehicle status and information**
- Maintenance alerts, fuel level, average fuel consumption and mileage



Vauxhall SOS

In the event of a breakdown or accident, you can count on Vauxhall Connect as your car has its own SIM card installed. If something happens that means there may have been an accident – say, the airbags are inflated or the pre-tensioners on the seatbelts are activated – an automatic message will go off to the emergency services, with details of your location. Vauxhall Connect SOS can be activated manually too – just press the button and you'll be put straight through to the emergency services on the system's integrated phone. So, if you have an accident, or see one, it only takes a few seconds to call for help.

Got a problem with your car but don't need the emergency services? Just press the Vauxhall Connect Assistance button and you'll be connected to our control centre over the system's integrated phone.

Convenience

- E-remote control (Plug-in HYBRID-e only)**
- Remote check of battery level, programming and charge management
- Pre-conditioning of vehicle temperature



E-remote

Check and manage your electric/hybrid vehicle range remotely and in real time using your smartphone. With MyVauxhall you can check the charge and range of your vehicle at any time, and if you're plugged into a charging point, you're even able to control charging when you're far away. To offer peace of mind, you can be alerted when the battery is full or the charging is interrupted.

The remote pre-conditioning feature allows you to warm or cool the vehicle to an optimal temperature before starting your journey. With your comfort in mind, this feature allows you to maximise range if your vehicle is on charge, by taking energy from the source, rather than the battery.

This service is supplied free of charge by Vauxhall for the life of the vehicle.

Drive Smart

- Live navigation† (subscription included for three years) with on-line traffic, fuel prices and parking information, Points Of Interest (POI) search and weather
- Trip and drive management**
- Timestamping of trips, trip details, last vehicle position, guide-to-car and more



Live Navigation Plus†

Vauxhall's fully integrated navigation system helps you stay informed, providing real-time information from the leading European GPS provider, TomTom®. It can be operated using natural voice recognition, meaning your eyes need never leave the road.

Vauxhall Live Navigation Plus is included free of charge for three years and can then be renewed at a cost.

- TomTom® services
- Real time traffic news
- Parking prices and availability
- Weather forecast on your journey
- Natural voice control
- Fuel prices at petrol stations
- Search for charging stations
- Quick search for addresses and points of interest
- Road safety alerts

Standard Features

Multimedia with 7-inch touchscreen

Standard on Design models

Onboard features:

- 7-inch colour touchscreen
- DAB Digital radio
- RDS with Traffic Programme
- AM/FM stereo radio with 25 station presets

Media connections:

- USB connection
- Bluetooth® A2DP audio streaming (Advanced Audio Distribution Profile)
- Six speakers

Mobile phone portal:

- Bluetooth® connectivity
- Handsfree calls via steering wheel controls
- Vehicle microphone
- Phone book access – contacts/last calls/missed calls etc. are mirrored on IntelliLink's display and are easily navigated using the touchscreen (features dependent on mobile phone)

Smartphone interface:

- Apple CarPlay
- Android Auto™
- Smartphone projection that allows operations via voice command, touchscreen and buttons to control apps and music playback

Additional features:

- Steering wheel mounted audio controls
- Flexible roof-mounted aerial

Multimedia Navi Pro with 10-inch touchscreen

Standard on GS Line and Ultimate models

Standard on GS Line and Ultimate Plug-in HYBRID-e models

Features as Multimedia, with the addition of:

Onboard features:

- 10-inch colour touchscreen

Navigation features:

- Satellite navigation system
- 2D/3D street level mapping
- European coverage
- Points-of-interest search
- Map updates via USB

Additional features:

- Shark fin aerial



Please note that compatibility and certain functions may be different depending on the type of device and operating system you're using with the Multimedia systems. Apple CarPlay is a trademark of Apple Inc. Apple and iPhone are trademarks of Apple Inc., registered in the U.S. and other countries. Android is a trademark of Google Inc, also registered in the U.S. and other countries.

Comfort and Convenience

Standard Features – The following features are standard across the entire New Grandland range. Specific features by model are outlined in the separate tabular information.

Interior Convenience

- Front 12-volt electrical accessory socket
- 60/40 split-folding rear seat backs
- Reach and rake-adjustable steering
- Steering wheel mounted audio/phone/cruise controls
- Rain-sensitive windscreen wipers
- Intermittent rear window wash/wipe
- Electronic parking brake with switch located in centre console

Interior Storage

- Front door pockets with 2.6-litre capacity
- Rear door pockets with 1.8-litre capacity
- Two drinks holders in centre console
- Covered storage compartment in centre console and in driver's armrest

Luggage area

- Luggage compartment foldable cover
- Illuminated luggage area
- Fully carpeted luggage area

Model Specific Features/Option

	Plug-in HYBRID-e models		Design	GS Line	
	GS Line	Ultimate		GS Line	Ultimate
Interior Convenience					
Driver's and front passenger's sunvisors with vanity mirrors			●		
Driver's and front passenger's sunvisors with illuminated vanity mirrors	●	●		●	●
Automatic dimming anti-dazzle rear-view mirror				●	●
Frameless automatic anti-dazzle rear-view mirror with LED spotlight	●	●			
Centre rear seat armrest				●	
Centre rear seat armrest with load-through facility	●	●			●
12-volt electrical accessory socket in luggage compartment and 230-volt accessory socket in rear/Wireless charger for mobile devices		●			●
Storage pocket on front seat backs		●			●
Luggage restraining net	£35*	£35*	£35*	£35*	£35*

*Optional at extra cost including VAT.

Standard Features – The following features are standard across the entire New Grandland range. Specific features by model are outlined in the separate tabular information.

Heating and Ventilation

- Electronic climate control incorporating air conditioning
- Dual-zone control – Allowing different temperature settings for driver and front passenger
- Advanced predictive logic control system using a sun sensor
- Charcoal filter – Removes dust, airborne particles, pollen and unpleasant odours
- Automatic air direction and fan speed with manual override
- Rear passenger compartment heating ducts

Exterior Convenience

- Soundproofed insulated windscreen
- Tinted windows
- Electrically operated front and rear windows with safety autoreverse and one-touch facility
- Twin electrically adjustable/heated power door mirrors (wide-angle on driver’s side) with automatic timed cut-off

Security

- Remote control security alarm system (operates in conjunction with central locking)
- Electronically protected audio equipment
- Engine deadlock immobiliser
- Luggage area cover

Remote control central locking

- Operates on doors, tailgate and fuel filler flap
- Deadlocking
- Central locking activation switch on driver’s door

Model Specific Features

	Plug-in HYBRID-e models		Design	GS Line	
	GS Line	Ultimate		GS Line	Ultimate
Heating and Ventilation					
Winter Pack – Heated front seats/Heated steering wheel		●			●
Heated windscreen					●
Thermal pre-conditioning – allows interior temperature to be optimised prior to departure maximising electric-only range	●	●			
Exterior Convenience					
High gloss black roof rails	●	●		●	●
Door mirror puddle light	●		●	●	
Power operated tailgate with foot sensor		●			●
Security					
Keyless entry and start		●			●

Design



Steering wheel:

- Three-spoke design
- Flat-bottomed leather-covered
- Satin chrome-effect bezel

Facia and door trim:

- Erino décor facia panel with palladium medium finish
- Black door panels with black Modene cloth inserts
- Chrome-effect interior door handles

Seating:

- Driver's and front passenger's seat:
 - Height
 - Reach
 - Backrest
 - Head restraint
- 60/40 split-folding rear seat backs

Seat trim:

- Berson black fabric seat trim inserts
- Modene black fabric side bolsters

GS Line



Steering wheel:

- Three-spoke design
- Flat-bottomed leather-covered
- Satin chrome-effect bezel

Facia and door trim:

- Dax décor facia panel with palladium medium finish
- Black door panels with black premium leather-effect inserts
- Chrome-effect interior door handles

Pedals:

- Sports, alloy-effect (auto only)

Seating:

- Ergonomic active driver's sports-style seat (AGR-approved*):
 - Height - Reach - Backrest
 - Seat cushion extension
 - Lumbar adjustment (four-way electrical)
 - Head restraint (two-way)
- Front passenger's sports-style seat (two-way adjustable)
 - Reach - Backrest - Head restraint
- 60/40 split-folding rear seat backs

Seat trim:

- Harlekin Curitiba black fabric seat trim inserts
- Black premium leather-effect side bolsters

VX_GRA_33209

Ultimate



Steering wheel:

- Three-spoke design
- Heated flat-bottomed leather-covered
- Satin chrome-effect bezel

Facia and door trim:

- Dax décor facia panel with palladium medium finish
- Black door panels with black premium leather-effect inserts
- Chrome-effect interior door handles
- Alloy-effect front door sill covers

Pedals:

- Sports, alloy-effect (auto only)

Seating:

- Ergonomic active heated sports-style front seats (AGR-approved*):
 - Height - Reach - Tilt - Backrest
 - Seat cushion extension
 - Lumbar adjustment (four-way electrical)
 - Head restraint
- 60/40 split-folding rear seat backs with centre rear seat armrest and load-through facility

Seat trim:

- Black Alcantara seat trim inserts
- Black premium leather-effect side bolsters

VX_GRA_32102

Safety and Lighting

Standard Safety Features – The following features are standard across the entire New Grandland range.

Airbags

- Driver's airbag
- Front passenger's airbag
- Front seat side-impact airbags
- Full-size curtain airbags for driver, front seat passenger and outer rear seat passengers

Seatbelts

- Inertia-reel lap and diagonal seatbelts for all seats
- Dual seatbelt pretensioners on front seats
- Pretensioners on outer rear seatbelt retractors
- Load limiters on outer rear seatbelt retractors
- Smart seatbelt reminder for front and rear seats – warning lights and audible warning

Braking

- Hill start assist – Briefly maintains rear brake pressure to stop the vehicle rolling back on an incline

Tyre pressure

- Deflation detection system

Child safety

- Deactivation switch for front passenger's front and side-impact airbags
- ISOFIX compatible child seat mountings located on front passenger's seat and outer rear seats (does not include child seat). Rear seat mountings incorporate top tether anchor points – allows ISOFIX child safety seats to be securely fixed into the car
- Child-proof locks on rear doors

Pedestrian safety

- Collapsible windscreen wiper system – designed to reduce pedestrian head injuries
- Upper and lower bumper design – reduces upper and lower leg injuries



Hill start assist.



ISOFIX child seat mountings.



Automatic emergency braking.

Standard Lighting Features – The following features are standard across the entire New Grandland range. Specific features by model are outlined in the separate tabular information.

Exterior Lighting

- LED headlights
- LED tail lights
- LED daytime running lights
- Automatic lighting control
- Lights-on audible warning
- High-level centre rear brake light

- Reversing light
- Hazard warning lights
- Door-to-door illumination
- Welcome lighting
- Manual beam levelling
- High beam assist

Interior Lighting

- Rear reading lights
- Illuminated luggage area
- Ambient lighting in front doors
- Ambient centre console downlighter

Model Specific Features

	Plug-in HYBRID-e models		Design	GS Line	
	GS Line	Ultimate		GS Line	Ultimate
Exterior Lighting					
IntelliLux adaptive LED® pixel headlights		●			●
LED front fog lights		●			●



LED headlight.



LED tail lights.



IntelliLux adaptive LED® pixel headlights.

Styling

Standard Features – The following features are standard across the entire New Grandland range. Specific features by model are outlined in the separate tabular information.

Exterior Styling

- Vizor grille
- Black door mirrors
- Black side window trim
- Body-colour door handles
- Rear spoiler

Model Specific Features

	Plug-in HYBRID-e models		Design	BEV models	
	GS Line	Ultimate		GS Line	Ultimate
Exterior Styling					
Body-colour roof			●		
Black roof (not available with Carbon Black)	●	●		●	●
Dark-tinted rear windows	●	●		●	●
Body-colour upper front bumper	●	●	●	●	●
Black-grained lower front and rear bumper, protective front and rear skid plates, front wheel arches, lower door cladding and C-shape bumper inserts			●		
High-gloss black protective front and rear skid plates and C-shape bumper inserts	●			●	
Carbon black lower front and rear bumpers, protective wheel arches, and lower door cladding	●			●	
Silver-effect protective front and rear skid plates					●
Body-colour lower front and rear bumpers, protective wheel arches and lower door cladding					●
Chrome Griffin for Vizor and tailgate with chrome Grandland tailgate lettering			●		
High-gloss black Griffin for Vizor and tailgate with high-gloss black Grandland tailgate lettering	●	●		●	●

Effective 6 April 2022

New Grandland Model Year 2022A

Exterior Colours

Arctic White (G2o)*
Brilliant paint



VX_GRA_33128

Quartz Grey (G4i)**
Two-coat metallic paint **£600**



VX_GRA_33131

Carbon Black (G7o)**
Two-coat metallic paint **£600**



VX_GRA_33132

Carmin Red (GDU)**
Two-coat premium metallic paint **£700**



VX_GRA_33130

Cobalt Blue (GYX)**
Tri-coat premium metallic paint **£700**





VX_GRA_33129

The colours reproduced may vary slightly from the actual paint colour. As a result they should be used as a guide only. Your Vauxhall Retailer has a comprehensive display of our paint samples.

*Standard exterior paint. **Optional at extra cost including VAT.

Please note, model shown for colour illustrative purposes only.

Wheels and Tyres

		Plug-in HYBRID-e models				
		GS Line	Ultimate	Design	GS Line	Ultimate
	17-inch 5-twin spoke silver-effect alloy wheels • 215/65 R 17 tyres • Emergency tyre inflation kit (in lieu of spare wheel)			●		
	18-inch 5-twin spoke high gloss black alloy wheels • 225/55 R 18 tyres • Emergency tyre inflation kit (in lieu of spare wheel)	●			●	
	19-inch diamond-cut bi-colour alloy wheels • 205/55 R 19 tyres • Emergency tyre inflation kit (in lieu of spare wheel)		●			●
Provision for spare wheel fitment (spare wheel is Retailer-fit)				£20*	£20*	£20*

*Optional at extra cost including VAT.

Plug-in HYBRID-e Specifications

Electrified Transmission

The 8-speed electrified transmission system is standard and offers both smooth transition between gears. The 8-speed electrified gearbox includes the following content:

- Multi-disc wet clutch replaces removed torque converter
- Permanent electric motor that transforms electric energy into mechanical drive energy
- Electric motor installed into the gearbox and petrol engine
- Comes with intuitive and stylish Automatic gearbox with electric shifter with shift paddles

Drive Mode Selector

The Drive Mode selector is positioned next to the Automatic gearbox with electric shifter and enables drivers to select one of the following:

- Hybrid is the default mode and offers the best of both worlds between controlled fuel consumption and on-road performance
- Sport Mode, draws on the combined power of the engine and motor for a more dynamic drive
- Electric activates the electric engine only, for zero CO₂ emissions and complete silence

Fuel tank capacity

- 43 litres (9.4 gallons)

Weights

- Kerbweight FWD: 1735kg
- Maximum towing weight FWD:
Braked trailer 1250kg (without brakes 600kg)

Charging

- Grandland Plug-in HYBRID-e range comes fitted with a type 2 charging cable and a 3.3kW on-board charger as standard. Includes cable bag at no extra cost
- A 6.6kW on-board charger can be purchased as an option for £500 inc VAT

This option halves the vehicle charging time when charging with a 7kW wallbox.

Please note: A type 2 cable (standard UK socket*) would charge the vehicle in less than 8 hours.

Grandland Plug-in HYBRID-e range charging time examples are listed showing times dependant on the various powers of charge point which the vehicle is plugged into.

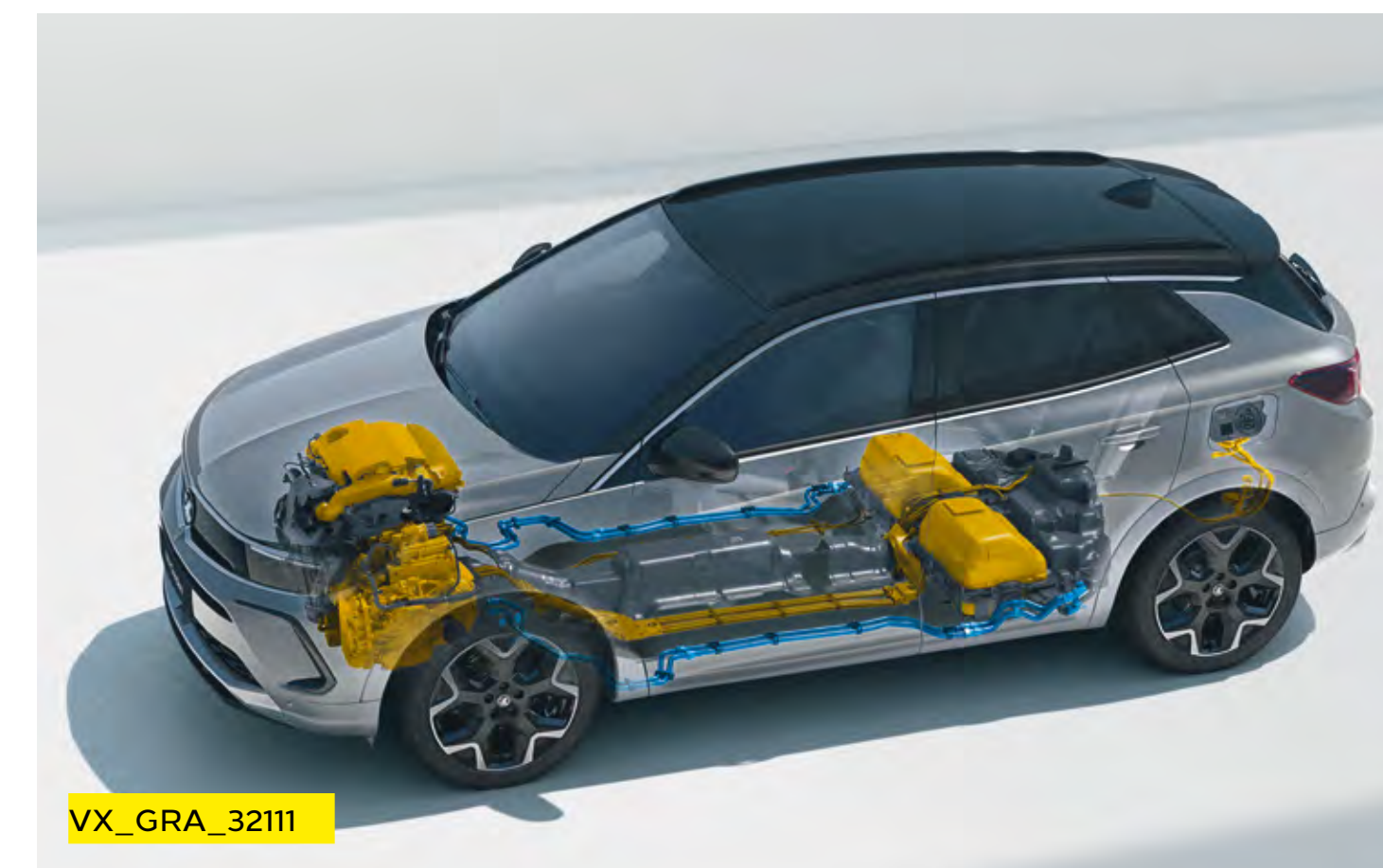

VX_GRA_32111



VX_GRA_32039

Charging		
Supply	Socket	Charge Time (0-100%)
AC current – Domestic 3 pin socket (2.3kW)	Type 2	5h 45m
AC current – Home wallbox or public charger (3.6kW)	Type 2	3h 30m
AC current – Home wallbox or public charger (7kW)**	Type 2	1h 45m

Preliminary data determined according to WLTP test procedure methodology. EG type approval and Certificate of Conformity are not yet available. Preliminary values may differ from official final type approval data. Charging rate depends on power source and charging cable used.

*Only use a domestic electrical socket that has been checked by a qualified electrician and is protected by a circuit breaker adapted to the amperage of the electrical circuit. **Requires optional 6.6kW on board charger.

Petrol Engine

Petrol Engine	1.6 (225PS) Direct Injection Turbo/Electric
Maximum power	180PS (133kW) @ 6000rpm
Combined power output	225PS (165kW)
Maximum torque	300Nm (221lb.ft.) @ 3000rpm
Combined torque	360Nm (265lb.ft.)
Combined CO ₂ emissions (WLTP)#	31g/km
Combined fuel economy (WLTP)#	192mpg (1.5l/100km)
Maximum speed/electric only	140/84mph
0-60mph	8.9 secs
Configuration	4 cylinders, 4 valves per cylinder, double overhead camshafts
Fuel/induction system	Turbocharger. Variable Valve Timing. Common rail direct injection
Emission compliance	Euro 6d

Electric Motor

Electric Motor	
Maximum power	110PS (81.2kW) @ 2500rpm
Maximum torque	320Nm (236lb.ft.) @ 500-2500rpm

Battery	
Battery capacity	13.2kWh
AC on-board charger speed (standard)	3.3kW
Equivalent Electric-only Range - EAER (WLTP high)#	39 miles
Energy consumption (WLTP Combined)	16.1kWh/100km
Battery warranty	8 years/100,000 miles/70% capacity

Please note, EV range assumes that vehicle has been pre-conditioned prior to journey. This function can be accessed via MyVauxhall App or Infotainment system.

These figures were obtained using a combination of battery power and fuel. The Grandland Plug-in HYBRID-e requires mains electricity for charging.

#WLTP Figures shown are for comparison purposes and should only be compared to the fuel consumption, CO₂ values and electric range of other cars tested to the same technical standard. The fuel consumption and electric range achieved, and CO₂ produced, in real world conditions will depend upon a number of factors including, but not limited to: the accessories fitted (pre and post registration); charging frequency; battery condition; variations in weather; driving styles and vehicle load. For more information contact your local Vauxhall Retailer.

Petrol Engine

	1.2 (130PS) Turbo
Capacity	1199cc
Maximum power	130PS (96kW) @ 5500rpm
Maximum torque	230Nm (169lb.ft.) @ 1750rpm
Configuration	3 cylinders, 4 valves per cylinder, double overhead camshafts
Fuel/induction system	Turbocharger. Variable Valve Timing. Common rail direct injection
Emission compliance	Euro 6d
Service interval	12,500 miles or 1 year (whichever occurs sooner)

Diesel Engine

	1.5 (130PS) Turbo D automatic
Capacity	1499cc
Maximum power	130PS (96kW) @ 3750rpm
Maximum torque	300Nm (221lb.ft.) @ 1750rpm
Configuration	4 cylinders, 4 valves per cylinder, double overhead camshafts
Fuel/induction system	Turbocharger with intercooler. Common rail direct injection
Emission compliance	Euro 6d Diesel Particulate Filter
Service interval	20,000 miles or 1 year (whichever occurs sooner)

Specifications

Start/Stop technology

Grandland's Start/Stop system, fitted as standard to all models, offers real benefits by improving fuel economy and reducing CO₂ emissions, particularly in town. It does this by automatically stopping the engine when you come to a standstill, and then restarting as you prepare to move off.

Before automatically stopping the engine a number of system checks are carried out to ensure that it is both safe and practical to do so. To ensure safety, the driver must depress the clutch pedal, shift in to neutral, and then release the clutch pedal. System checks carried out before Auto Stop activates include:

- Start/Stop system is not manually deactivated via the facia button
- Sufficient brake vacuum is available to prevent the car rolling down an incline
- Battery is in good condition and charged
- Outside air temperature and engine temperature are above specified minima
- Electronic climate control (where fitted) is not in maximum heating or maximum cooling mode
- Self-cleaning function of the diesel particulate filter is not active

If all of these conditions are satisfied then the vehicle will Auto Stop.

When you are ready to pull away from standstill, Auto Restart is activated by depressing the clutch pedal.

Whilst at a standstill the vehicle is continually monitored. If necessary, the engine will automatically be restarted. Conditions that would initiate an Auto Restart include:

- Low battery level
- Brake vacuum below specified minimum
- Start/Stop system is manually deactivated
- Stationary for 5.5 minutes

Fuel tank capacity

- 53 litres (11.6 gallons)

AdBlue[®] tank capacity

- 17 litres (3.7 gallons)

Transmissions

Six-speed manual gearbox

Standard on all models.

Eight-speed automatic transmission

Available at extra cost on all models.

Steering

- Speed-sensitive electric power-assisted steering

Suspension

Front: Independent. Decoupled MacPherson struts with gas-pressure dampers and coil springs.

Anti-roll bar.

Rear: Compound crank with coil springs and gas-pressure dampers.

Braking and stability

- Switchable Electronic Stability Programme (ESP)
- Anti-lock Braking System (ABS)
- Corner stability control
- Traction control
- Hill start assist
- Hydraulic brake assist
- Electronic brakeforce distribution

All models

Front ventilated discs: 304mm diameter

Rear discs: 268mm diameter

Performance, Fuel Economy and Emissions

	Performance (manufacturer's figures)		Fuel economy mpg (litres/100km)#		CO ₂ emissions g/km#		Vehicle Excise Duty*		BiK rates from - 2022/23 tax year
	Maximum speed (mph)	Acceleration 0-60mph (sec)	Combined Low	Combined High	Combined Low	Combined High	First year rate	Standard rate	
1.2 (130PS) Turbo	122	10.4	44.8 (6.3)	45.6 (6.2)	139	142	£230	£165	32%
1.2 (130PS) Turbo auto	121	10.3	43.4 (6.5)	44.1 (6.4)	144	148	£230	£165	33%
1.5 (130PS) Turbo D auto	119	12.3	53.3 (5.3)	54.3 (5.2)	133	138	£230	£165	31%

Weights and Towing Data^{kg}

	Gross vehicle weight	Maximum towing weights Trailer with brakes (without brakes)
1.2 (130PS) Turbo	1930	1400 (600)
1.2 (130PS) Turbo auto	1955	1200 (600)
1.5 (130PS) Turbo D auto	2000	1300 (600)

#Figures shown are for comparison purposes and should only be compared to the fuel consumption and CO₂ values of other cars tested to the same technical standard. The fuel consumption achieved, and CO₂ produced, in real world conditions will depend upon a number of factors including, but not limited to: the accessories fitted (pre and post registration); variations in weather; driving styles and vehicle load. The WLTP (Worldwide Harmonised Light Vehicles Test Procedure) is used to measure fuel consumption and CO₂ figures. The CO₂ figures display a range to reflect the highest value for the highest emitting version with all available options added, through to a minimum value to represent the lowest emitting version in standard specification.

*Correct at time of publication.

Please note: Gross vehicle weight is the total permissible weight of the vehicle including passengers and their luggage. The **maximum roof rack loading** should not exceed 70kg. The **maximum towing weights** are based on the ability of the car, with two occupants of 75kg each, to restart on a 12% gradient, which is approximately 1 in 8.3, at sea level. The permitted trailer load applies up to the specified incline and up to an altitude of 1000 metres above sea level. The permissible gross train weight decreases by 10% for every 1000 metres of additional altitude. At altitudes above 1500 metres, the engine output may drop with a corresponding reduction in towing capability. Any extra weight, such as luggage or additional passengers, should be deducted from the maximum towing weight. With a trailer fully loaded, **maximum noseweight** should not exceed 75kg. Always fit Vauxhall towing attachments and accessories available from your Vauxhall Retailer. They are designed specifically for Vauxhall models and carry a 12-month guarantee. During trailer towing do not exceed a maximum speed of 60mph. This speed limit is also applicable in countries with higher permitted speeds for trailer-vehicle combinations. Pay attention to the local speed limits. For trailers with low driving stability and caravans the use of an oscillation damper is strongly recommended.

Dimensions and Capacities All measurements in mm (inches) unless stated otherwise.

VX_GRA_33127

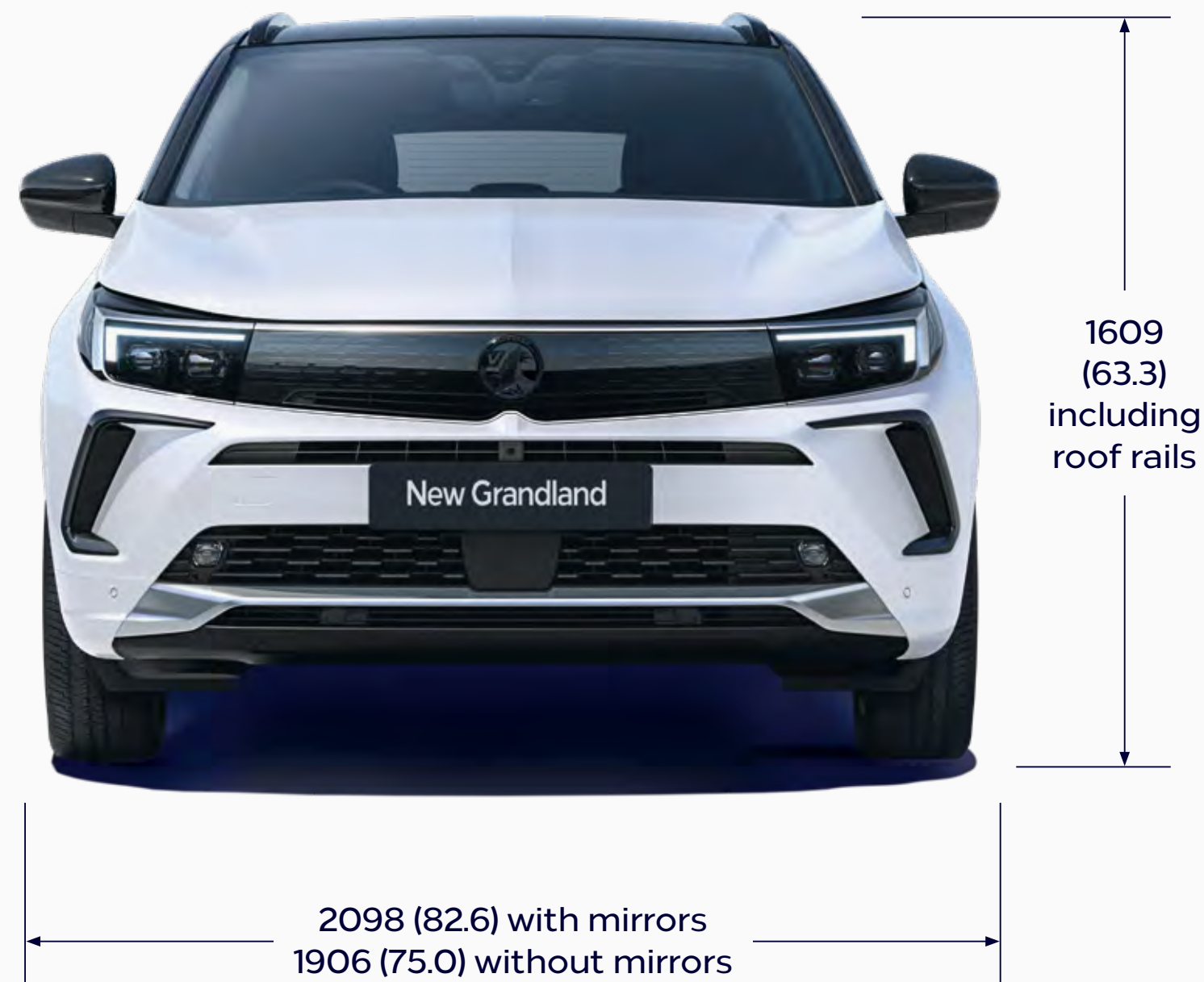

VX_GRA_33126

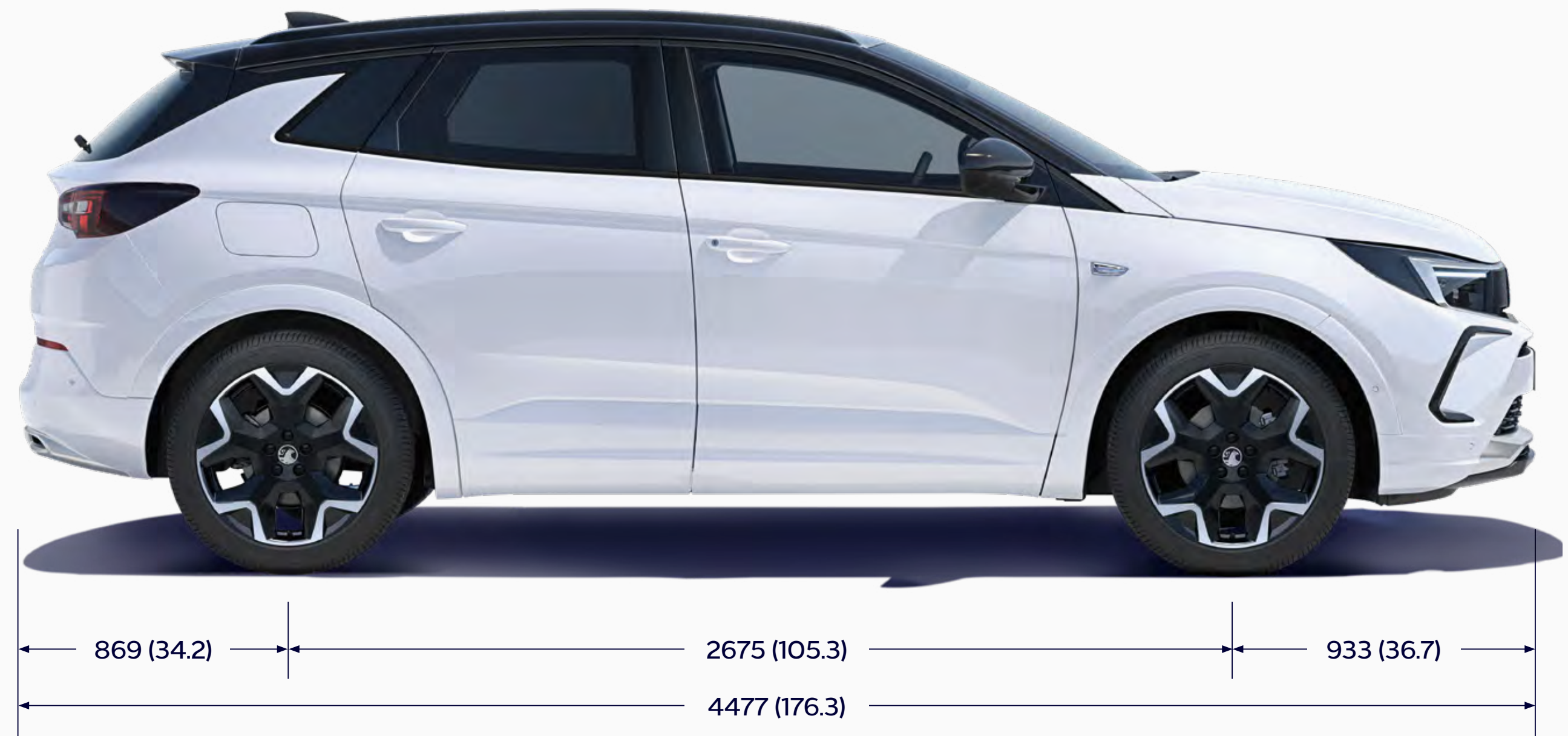

Loadspace Dimensions	Petrol/Diesel	Plug-in HYBRID-e range
Maximum length (behind rear seats)	873 (34.4)	873 (34.4)
Maximum length (rear seats folded)	1696 (66.8)	1696 (66.8)
Maximum width	1053 (41.5)	1053 (41.5)
Maximum height	987 (38.8)	987 (38.8)

Luggage Capacities* Litres (cu.ft.)	Petrol/Diesel	Plug-in HYBRID-e range
Rear seats up (under luggage compartment cover)	514 (18.1)	390 (13.7)
Rear seats folded (to roof)	1652 (58.3)	1528 (53.9)

*Measured using the ECIE method.

Accessories

Safety	Total (inc. VAT)
Spare wheel kit with 18-inch emergency wheel and tool kit ^{1,2}	£193
Side steps	£630
Philips ADR620 dash cam	£109
Front parking sensors	£415
Rear parking sensors	£455
Rear view camera ³	£380
Vehicle alarm system kit	£506
Child seats ⁴	
- Group 0 (0-13kg) – Britax Romer Baby Safe	£239
- ISOFIX Base, Rear-facing for Britax Romer Baby Safe	£251
- Group 2/3 (15-36kg) – Britax Romer KIDFIX 2 R	£317
- Group 2/3 (15-36kg) – Britax Romer KIDFIX XP	£352
- Group 3 (22-36kg) – Booster Seat without Seatback	£76
Safety Pack – first aid kit, hi-vis vest and warning triangle	£16
Warning triangle	£9
Hi-vis safety vest – adult	£4
Hi-vis safety vest – child 3-6 years (42cm)	£4
Hi-vis safety vest – child 7-12 years (52cm)	£4
First aid kit	£15
Emergency seat belt cutter and hammer	£19
Fire extinguisher (1kg) with strap	£23
Under seat bracket for fire extinguisher	£50
Spare bulb kit – 11 x high-quality bulbs and 7 x fuses from Philips	£70

Protection	Total (inc. VAT)
Vertical cargo net	£27
Dog guard	£232
Front and rear splash guards	£122
Accessories for petrol/diesel models	
Floor mats (set of 4)	
- Carpet	£38
- Velour	£75
- Rubber	£50
Boot mat	£136
Boot tray	£73
Accessories for Plug-in HYBRID-e models	
Floor mats (set of 4)	
- Carpet	£41
- Velour	£75
- Rubber	£56
Boot mat	£123
Boot tray	£79

Style	Total (inc. VAT)
Door sills	
- Front	£41
- Rear	£69
Sport pedal covers	
- Manual	£46
- Automatic	£36

Comfort	Total (inc. VAT)
USB charger – 2 front and 2 rear ports	£28
FlexConnect bracket	£20
FlexConnect hook	£37
FlexConnect coat hanger	£41
FlexConnect folding table	£102
FlexConnect iPad Mini holder	£127
FlexConnect iPad holder	£106
FlexConnect iPad Air holder	£106
FlexConnect Samsung Galaxy 10.1 holder	£127
Privacy shades for rear and side rear windows (set of 4)	£136
Cupholder organisers	£8-10
Smoker's kit	£53
Fragrance diffuser	£24
Fragrance cartridge (various)	£18

Electric	Total (inc. VAT)
Mode 2 emergency charging cable (Type G – UK domestic plug)	£584
Mode 3 charging cable	
- 7.4kW	£331
- 11kW	£371
- 22kW	£438
Cable bag	£49
Mode 2 Universal Charger UK kit (22kW)	£1,555
Accessories for Universal Charger	
- Wall bracket	£105
- Bag	£65
- Safety lock	£20
- Adapter Type 2	£318
- Adapter Type 3c	£358
- Adapter (various)	£120

Transport solutions	Total (inc. VAT)
Roof base carrier (set of 2 bars) ⁵	
- Without roof rails	£253
- With roof rails	£183
Roof carriers (requires base carrier)	
Roof box – Thule Ocean 80	£164
Roof box – Thule Ocean 200	£374
Roof box – Thule Touring 200	£428
Roof box – Thule Touring 700	£492
Roof box – Thule Motion 800	from £426
Bike carrier – Thule FreeRide 532	£81
Bike carrier – Thule Expert 298	£134
Surfboard carrier – Thule 833	£84
Kayak carrier – Thule Hull-a-Port Pro 837	£234
Ski/snowboard carrier	
- Thule Snow Pack 7324 (4 x pairs)	£147
Ski/snowboard carrier	
- Thule Snow Pack 7326 (6 x pairs)	£265
Towing	
Swan's neck towing ball and 13-track wiring loom	
- Petrol/diesel models	£589
Tow bar with removable tow ball and 13-track wiring loom	
- Petrol/diesel models	£722
- Plug-in HYBRID-e models	£869
13-pin to 7-pin adapter	£30

Please note: Prices shown are fully fitted and painted, where applicable and include VAT. Please check with your local Vauxhall Retailer for details. It is advisable to ensure your insurance policy is adequate to cover additional fitted accessories. Prices correct at time of publication.

¹Vehicle must be ordered with spare wheel fixing option (T7Y) in order to accommodate the spare wheel. ²Petrol and diesel models only. ³For manual transmission only. ⁴Restrictions apply to the use of child seats, please consult your vehicle user manual or Vauxhall Retailer.

⁵A dedicated T-Track adapter (Thule 697-4 or Thule 697-6) is required for the installation of specific roof boxes, contact your local Vauxhall Retailer for details.

Company Car Driver and Fleet Information

Benefit in kind company car taxation*

The car benefit charge will be the car's list price (including VAT, options and accessories fitted, delivery to Retailer and number plates, but excluding Vehicle Excise Duty and new vehicle first registration fee) multiplied by the percentage charge for the CO₂ emissions band in which the car falls (see table opposite). Multiply this figure by your personal income tax rate (20%** for Basic Rate, 40%** for Higher Rate) to calculate your annual benefit in kind tax liability.

Generic example:

HYBRID-e vehicle: 24g/km CO₂, up to 43 miles (electric-only range)

On-the-road RRP	£32,200.00
Deduct: Vehicle Excise Duty	-£10.00
New vehicle first registration fee	-£55.00
Effective list price	£32,135.00
Add: Optional two-coat metallic paint	£600.00
List price for tax purposes (P11D value)	£32,735.00
Car benefit charge 2022-23 tax year (28%)	£2,619.00
Benefit in kind tax liability	
Basic Rate (20%) tax payer	£523.80
Higher Rate (40%) tax payer	£1,047.60

*Please note this Price Guide provides taxation information as a guide only. Vauxhall does not provide taxation guidance. Drivers should always take professional advice on their own tax position.
**Excludes residents of Scotland.

BiK for Scottish Residents

Effective 6 April 2018 the Scottish Government have introduced their own BiK taxation structure. This only applies to Company Car Drivers that are Scottish taxpayers. HMRC will determine whether or not an individual is a Scottish taxpayer based on where their main place of residence is.

The BiK rates for Scotland are:

- Over £12,570 - £14,732 Starter Rate 19%
- Over £14,732 - £25,688 Basic Rate 20%
- Over £25,688 - £43,662 Intermediate Rate 21%
- Over £43,662 - £150,000 Higher Rate 41%
- Above £150,000 Top Rate 46%

CO ₂ emissions (g/km)	Percentage of cars price to be taxed 2022-23 tax year
Up to 50	14%
51 - 54	15%
55 - 59	16%
60 - 64	17%
65 - 69	18%
70 - 74	19%
75 - 79	20%
80 - 84	21%
85 - 89	22%
90 - 94	23%
95 - 99	24%
100 - 104	25%
105 - 109	26%
110 - 114	27%
115 - 119	28%
120 - 124	29%
125 - 129	30%
130 - 134	31%
135 - 139	32%
140 - 144	33%
145 - 149	34%
150 - 154	35%
155 - 159	36%
160 - 164	37%
165 - 169	37%
170+	37%

CO ₂ emissions (g/km)	Electric range (miles)	Percentage of cars price to be taxed 2022-23 tax year
0	-	2%
1 - 50	130+	2%
1 - 50	70 - 129	5%
1 - 50	40 - 69	8%
1 - 50	30 - 39	12%
1 - 50	<30	14%

To calculate your own personal liability, search: **Vauxhall BiK**, or click the link below: [Vauxhall BiK Tool](#)

Fleet Toolbox

Discover the facts in our online Toolbox for both Company Car Drivers and Fleet Decision Makers. The Fleet Toolbox has a host of useful calculators, comparators, interactive listings and information.

Search Vauxhall Fleet Tools or click the link below: [Vauxhall Fleet Tool Box](#)

Contact Vauxhall Fleet

Please contact one of our dedicated sales teams who will be happy to help with your particular enquiry.

Company Car Drivers

Call: 0345 111 2020

Email: company-car@vauxhallinfo.co.uk

Telephone lines are open

- Monday to Friday 8:00am-9:00pm

- Saturday and Sunday 9:00am-6:00pm

Fleet Decision Makers

Depending on the size of your fleet of vehicles, we have a dedicated team to handle your enquiries. The lines are open Monday to Friday excluding Bank Holidays.

1-24 vehicles

Call: 0845 076 2254 (8:30am-5:00pm)

25+ vehicles

Call: 0330 587 8222 (8:30am-5:00pm)

Email: vauxhallfleet@vauxhall.co.uk

Special Vehicles (Police, Fire and Ambulance)

Call: 01582 409999 (8:30am-5:00pm)

Email: vauxhallspecialvehicles@vauxhall.co.uk

Further Information

On-the-road prices

To eliminate uncertainty about hidden costs when buying a new car, Vauxhall publishes on-the-road recommended retail prices (RRP) and these are shown in the pricing tables within this price guide. These prices include VAT, number plates and delivery to Retailer of £700.00 (including £116.67 VAT), 12 months' Government Vehicle Excise Duty (see opposite for details) and the DVLA new vehicle first registration fee of £55.00.*

Please note: The on-the-road recommended retail price (RRP) does not include fuel supplied by the Retailer, motor insurance or any other goods or services supplied by agreement between the Retailer and the customer.

Price protection

Order a new Vauxhall for build in the current model year (as confirmed by your Retailer) for delivery no more than three months in advance and the price you are quoted is the price you pay. This is irrespective of any subsequent price rises between placing your order and delivery of your new car, but you must take delivery as soon as the car is available.

Please note: Price protection does not apply to electric/Plug-in HYBRID-e models. Vauxhall Motors Limited is not liable for price adjustments caused by Government changes in the rate of VAT (currently 20%), Vehicle Excise Duty, DVLA new vehicle first registration fee or by any other applicable legislation or regulations.

In the event of an accident

Vauxhall Accident Management helps keep you mobile following an accident. Benefits include vehicle recovery, Vauxhall-approved repairs and contacting your insurer. For more details, visit vauxhall.co.uk/AccidentManagement

Free2Move Lease

Whether you're a big company or a small business looking for vehicle financing, Free2Move Lease, our business finance specialists, can deliver exactly what you need.

Free2Move Lease is one of the UK's largest leasing companies and is also a member of the British Vehicle Rental and Leasing Association (BVRLA).

With over 60,000 vehicles in the Free2Move Lease portfolio, Free2Move Lease is able to offer competitive vehicle solutions. In addition, Free2Move Lease also offer innovative connected management of servicing and maintenance.

For further information, please contact your local Vauxhall Retailer or visit vauxhall.co.uk/offers-finance/business-leasing.html

Vehicle Excise Duty

The amount of Vehicle Excise Duty (road fund licence) payable on new cars varies depending on the level of carbon dioxide (CO₂) emissions produced by the vehicle. CO₂ emissions are measured in grams per kilometre (g/km) travelled and divided into 13 charging bands shown in the table opposite.

A 'first year rate' of Vehicle Excise Duty is payable on all new cars and in subsequent years the amount payable reverts to the 'standard rate'. From 1 April 2017 the breakpoints for each of these bands have been revised. Also, for vehicles with a list price over £40,000, including factory-fitted options, an additional £335 is payable for the first five years of standard rate payments.

Vehicle Excise Duty*

Band	CO ₂ emissions in grams per kilometre	First year rate Petrol/Diesel	Standard rate Petrol/Diesel	Standard rate Hybrid
A	0	£0	£0	£0
B	1 – 50	£10	£165	£0
C	51 – 75	£25	£165	£15
D	76 – 90	£120	£165	£110
E	91 – 100	£150	£165	£140
F	101 – 110	£170	£165	£160
G	111 – 130	£190	£165	£180
H	131 – 150	£230	£165	£220
I	151 – 170	£585	£165	£575
J	171 – 190	£945	£165	£935
K	191 – 225	£1,420	£165	£1,410
L	226 – 255	£2,015	£165	£2,005
M	Over 255	£2,365	£165	£2,355

*Correct at time of issue.

Further Information

Customer Care Commitment

For added peace of mind, Vauxhall has an innovative Customer Care Commitment that offers the following:

- Three-year vehicle warranty consisting of a one-year/unlimited mileage manufacturer's warranty and a second and third year manufacturer's warranty with a 60,000 miles limitation
- Vauxhall Assistance for 12 months from first registration
- Six years' body panel anti-perforation warranty

Please note: Warranty is only available on vehicles sourced from Vauxhall Motors Limited. Terms and conditions apply – please see your Vauxhall Retailer for details.

Vauxhall Assistance

Vauxhall Assistance is provided automatically with every new Vauxhall for 12 months from first registration and covers everything from accident assistance, roadside recovery and 'at home' service to flat tyres. For even more peace of mind, for Plug-in HYBRID-e models the cover is extended* to 8 years or 100,000 miles, whichever comes first. Even more reason for you to stay calm and let us take care of everything should the need arise. With Vauxhall Assistance help is literally just a free** phone call away, 24 hours a day, 365 days a year!

Protecting the environment

Vauxhall's commitment to the environment is demonstrated by our products' many environmental awards. For even more information on Vauxhall's efforts to achieve an environmentally sustainable future, and how to dispose of your end-of-life vehicle, see vauxhall.co.uk/recycling

Vauxhall Care

This all-inclusive service package is available on Vauxhalls under 10 months old (from date of first registration).

This package offers complete peace of mind for the first 3 years of your Vauxhall's life with fixed monthly payments for the plan duration.

- **3 years' Vauxhall servicing** – covers first, second and third annual services. Including a brake-fluid change in the second service
- **2 years' Vauxhall Roadside Assistance** – first year from us
- **First years' MOT[†]** – free of charge by your local Vauxhall Retailer

For full terms and conditions and to sign up, visit: vauxhall.co.uk/vauxhallcare

Vauxhall Service Club

Vauxhall Service Club is available for all Vauxhall owners, and it's free to join. Members benefit from the following:

- 15% off Vauxhall Approved Accessories
- Vauxhall's aged 2-3 Years = 15% off parts and labour
- Vauxhall's aged over 3 Years = 25% off parts and labour
- Half price MOT's (NI excluded)
- Free pre-MOT test inspection (NI only)
- Fixed price AdBlue® Refills
 - Car = £14.99
 - Van = £24.99
- Access to the Vauxhall Accident Management Programme
- Online service booking available 24/7 with servicing appointments available within 3 days – [Book Online](#)
- Collection and delivery/onward mobility options
- Complimentary 'Wash and Vac' with all routine services^{††}
- Vauxhall trained technicians
- Genuine Vauxhall parts
- Minimum 12 months warranty on parts and labour
- Regular newsletters with exclusive offers, discounts and competitions

Terms and conditions apply. To join visit: vauxhall.co.uk/serviceclub

Vauxhall Insurance with added reassurance

Comprehensive cover – Summary of benefits

- Competitive premiums
- Repairs by a Vauxhall-trained technician
- Genuine Vauxhall parts, guaranteed for five years when we repair your car within our Approved Repairer Network
- Free courtesy car as standard when using an Approved Repairer[‡]
- 24 hour claims helpline
- Personal Accident benefit
- Cover for audio equipment
- Windscreen cover

Call for a quote on 0330 678 1130^{‡‡}

For more product information

For further information on the Vauxhall range or location of your nearest Vauxhall Retailer please call 0345 600 1500. Alternatively, details can be found on our website at vauxhall.co.uk

For more information call **0345 600 1500**

For Fleet enquiries call **0330 587 8222**

Discover the full Vauxhall range at **[vauxhall.co.uk](https://www.vauxhall.co.uk)**

Join us online

The invoice price, including delivery to Retailer, factory-fitted options, accessories fitted by the Retailer and number plates, is subject to VAT. Some feature descriptions in this guide may refer to, and some illustrations may show, optional equipment not included in the standard delivery. The information contained in this guide was accurate at the time of publication. We reserve the right to make changes in design and equipment. Please note that Vauxhall Retailers are not the agents of Vauxhall Motors Limited and are not authorised to bind Vauxhall Motors Limited by any specific or implied undertaking or representation. It is advisable to ensure that your motor insurance policy provides adequate cover for additional fitted options and accessories. The colours in this guide are only approximate actual colours. Illustrated optional equipment is available at extra charge. Availability, technical features and equipment provided on our vehicles can vary by model. For precise information on the equipment provided on our vehicles, please contact your local Vauxhall Retailer.

VAUXHALL

Price and Specification Guide
13 May 2022 | Model Year 2022C



Combo-e Life

Contents

To find the information you want use the links below to navigate around the guide:

[Feature highlights](#)

[Prices](#)

[Features/Options](#)

[Infotainment](#)

[Interior Style and Comfort](#)

[Exterior Colours](#)

[Wheels and Tyres](#)

[Specifications](#)

[Dimensions and Capacities](#)

[Accessories](#)

[Company Car Information](#)

[Further Information](#)

Combo-e Life SE



VX_COM_e_31978

SE

OTR from £29,610*

Infotainment:

- Multimedia system
 - 8-inch colour touchscreen
 - DAB digital radio
 - Bluetooth®
 - Apple CarPlay/Android Auto™
 - Front and rear USB connection
- Six speakers
- Vauxhall Connect

Interior convenience/styling:

- 10-inch colour instrument display
- Height-adjustable driver's seat
- Air conditioning
- Steering wheel mounted audio controls
- 60/40 split-folding rear seat back
- Chrome-effect interior door handles
- Luggage compartment cover
- Chrome-effect instrument rings
- Leather-covered steering wheel
- Fold-flat front passenger seat with armrest
- Front-seat back pockets
- Two foldable tables with cupholders
- Electronic parking brake

Exterior convenience/styling:

- Nearside and offside sliding side-access door with opening windows
- Tailgate with opening heated rear window and wiper
- Body-colour front and rear bumpers
- Body-colour side protection mouldings
- Body-colour door handles and side-access door rail covers
- Body-colour door mirrors
- Front fog lights
- 16-inch alloy wheels
- Emergency tyre inflation kit

- Electrically adjustable/foldable/heated door mirrors
- Sight and Light Pack
 - Rain-sensitive windscreen wipers
 - High beam assist
- Electrically operated front and rear windows
- Dark-tinted rear windows
- Panoramic rear-view camera
- LED daytime running lights

Safety/security:

- Rear parking distance sensors
- Automatic emergency braking with pedestrian detection
- Electronic stability programme with traction control
- Anti-lock braking system
- Forward collision alert
- Emergency brake assist
- Lane departure warning with lane keep assist
- Automatic lighting control
- Cruise control with speed limiter
- Speed sign recognition
- Six airbags
- Driver drowsiness system
- Tyre pressure monitoring system

SE XL 7-seat OTR from £30,210*

7-seat models additionally feature:

- Two individual split-folding and removable third-row seats
- Sliding facility for third-row seats

*Price shown is after allowing for PiCG (Plug-in Car Grant).

Combo-e Life Prices

	Pack Code	Orderable Option Code	Price (£)	VAT (£)	Total (£)	On-the-road RRP before PiCG (£)	On-the-road RRP after PiCG (£)	Financial Year 2022/23 BiK 20% (£)	WLTP Combined CO ₂ (g/km) – pack code	Insurance groups
SE (5-seat)										
100kW (136PS) auto – 50kWh battery	DS26 9EQ1	XIAK	25,295.83	5,059.17	30,355.00	31,110.00	29,610.00	10.35	0	tba
SE XL (7-seat)										
100kW (136PS) auto – 50kWh battery	DS26 9EQ2	XIAL	25,795.83	5,159.17	30,955.00	31,710.00	30,210.00	10.55	0	tba

WLTP figures are based on a configured vehicle as per pack code for UK with no options fitted as at 23 November 2021.

#The Combo-e Life is a battery electric vehicle requiring mains electricity for charging. Range data given has been determined according to WLTP test procedure methodology. The figures shown are intended for comparability purposes only and should only be compared to other cars tested to the same technical standard. The range you achieve under real world driving conditions will depend upon a number of factors, including but not limited to: the accessories fitted (pre and post registration); charging frequency; personal driving style; vehicle load and route characteristics; variations in weather; heating/air conditioning; pre-conditioning and battery condition. For more information, contact your local Vauxhall Retailer.

Please note: On-the-road recommended retail prices (RRP) include number plates and delivery to Retailer of £700.00 (inc. £116.67 VAT), 12 months' Vehicle Excise Duty and new vehicle first registration fee of £55.00. Excludes fuel and insurance. Company Car Benefit in Kind (BiK) rates are monthly based on the standard paint price. Price has been calculated using manufacturer estimates and includes a £1,500.00 OZEV grant which has been deducted from the price of the vehicle (OZEV Grant not available in the Isle of Man). New Combo-e Life is expected to be a qualifying model for this grant subject to acceptance by OZEV. Please check with your Retailer for latest status. The grant is a government incentive and is subject to withdrawal prior to delivery of your vehicle. Retailers may be required to carry out more than one credit check during the course of the order process. You may be required to place a deposit when placing your order with your supplying Retailer. In the event of a price change, deposit refunds will be governed by your supplying Retailer's policy and as such must be discussed with the supplying Retailer.

New Combo-e Life is not covered by our Price Protection Guarantee. See 'Further Information' page for details.

Safety

Standard Features

Airbags

- Driver's airbag
- Front passenger's airbag
- Two front seat side-impact airbags
- Full-size curtain airbags

Seating

- Three height adjustable rear seat head restraints

Seatbelts

- Lap and diagonal inertia-reel seatbelts
- 'Seatbelt unfastened' audible warning and warning light

Braking

- Automatic emergency braking – The system works automatically in conjunction with forward collision alert, at speeds between 3mph and 70mph, and detects both vehicles and pedestrians. If no avoiding action is taken by the driver, at speeds below 19mph the system automatically slows the vehicle to a full stop with emergency braking of 0.9g. At speeds from 19mph to 70mph it brakes automatically to reduce speed by a maximum of 30mph – to reduce speed even further the driver must brake themselves

- Anti-lock Braking System (ABS)
- Electronic brakeforce distribution – Automatically apportions the optimum braking force to each wheel
- Engine drag torque control – Improves directional stability by preventing the driven wheels from locking on slippery surfaces under the influence of engine braking
- Hill start assist – Briefly maintains rear brake pressure to stop the vehicle rolling back on an incline

Child safety

- Deactivation switch for front passenger's front and side-impact airbags
- ISOFIX child seat mountings incorporating top tether anchor points located on second-row rear seats (does not include child seat) – Allows ISOFIX child safety seats to be securely fixed into the car. The ISOFIX mounting system reduces forward movement in an accident and makes the child seat easier to install
- Child-proof locks on rear doors

Stability

- Electronic Stability Programme (ESP) – ESP monitors many different inputs to determine when the car starts to lose traction, it can then immediately respond by varying the brake pressure between up to three wheels and adjust the engine output to help correct the loss of traction and improve stability

Additional ESP features

- Traction control
- Cornering brake control
- Straight line stability control
- Drag torque control – Maintain stability on slippery roads when lifting off the accelerator or changing gear

Tyre pressure

- Tyre pressure monitoring system



Automatic emergency braking.



ISOFIX child seat mountings.



Lane departure warning (see next page for feature description).

Driver Assistance

Standard Features

Cruise control with speed limiter

With steering wheel mounted controls. Enables you to maintain a constant speed, making it ideal for economical motorway driving.

Steering

- Speed sensitive electrically assisted power steering
- Reach and rake adjustable steering column

Front camera system

A range of class-leading driver assistance and safety features are controlled by the front camera system

Parking sensors

- Rear parking distance sensors

Forward collision alert

The system operates automatically from 3mph and gives an audible warning as well as a visual warning when approaching another vehicle too quickly

Speed sign recognition

Detects and then displays speed limits, reducing uncertainty and the risk of speeding.

- Recognises different speed signs, including temporary speed restrictions
- Displays reminder in the instrument cluster

Driver drowsiness system

The system monitors driving time and driving behaviour to help prevent accidents caused by tiredness.

Lane departure warning with lane keep assist

If the driver has not actively steered or signalled, the lane departure warning system provides gentle steering correction and warns when the car moves outside of lane markings at speeds above 40mph.

- Warning light in instrument cluster
- Audible warning
- Facia on/off switch

Wipers

- Intermittent rear window wash/wipe
- Magic Wash System – Mounted in the front windscreen wipers, Combo-e Life models benefit from our innovative windscreen wash system, designed to more effectively distribute water and reduce wastage. Using nozzles located above the wiper blades, fluid is distributed as the wiper sweeps the windscreen. This avoids the ‘temporary blindness’ of more conventional bonnet mounted systems between fluid release and wiper sweeping, improving visibility

Features/Options

		Electric model
	Option code*	SE
Driver Assistance		
Panoramic rear-view camera		●
Front and rear parking distance sensors	UD5	£480
Intelligrip	PS4	£410
Sight and Light Pack – High beam assist/Rain-sensitive windscreen wipers		●
11kW three-phase on-board charger	K29	£360

*Optional at extra cost including VAT.

Driver Information and Security

Standard Features

Driver Information

Instrumentation

(see Specifications for further details)

- Speedometer

Driver information display

(centrally located in instrument cluster)

- Trip computer data
- Total mileage
- Service-due indicator
- Tyre pressure monitoring system

Multi-function trip computer

(displayed on driver information display)

- Trip mileage
- Vehicle range
- Average speed
- Driving time

Central facia display

(format dependent on infotainment unit)

- Audio information
- Digital clock with automatic RDS time adjustment
- Outside air temperature with ice warning function
- Additional features dependent on infotainment unit (see infotainment for details)

Security

- ‘Key left in ignition’ audible warning
- Electronically protected audio equipment
- Engine deadlock immobiliser
- Visible Vehicle Identification Number (VIN)
- Locking wheel bolts for alloy wheels
- Freewheeling door locks

Remote control central locking

- Operates on doors, tailgate and fuel filler flap
- Deadlocking
- Central locking activation switch on driver’s door

Feature/Option

Feature/Option		Electric model
	Option code*	SE
Driver Information		
10-inch colour information display		●
Security		
Remote control ultrasonic security alarm system	PS6	£200

*Optional at extra cost including VAT.

Convenience

Standard Features

Interior Convenience

- Front 12-volt electrical accessory socket
- Driver's sun visor incorporating vanity mirror with cover
- Dipping rear-view mirror
- Steering wheel mounted audio controls
- Front and rear USB connection

Interior Storage

- Two facia-mounted drinks holders
- Two drinks holders in centre console
- Large open storage pocket behind infotainment screen
- Interior courtesy light
- Front map reading lights
- Luggage compartment lighting
- Small open storage compartment behind gear knob
- Two front large and small door pockets
- Two rear door pockets
- Open storage compartment below glovebox
- Full-width overhead storage shelf with ambient lighting

Luggage Area

- Luggage compartment cover
- Illuminated load area
- Fully carpeted load area
- Interior tailgate handle
- Four load restraint lashing eyes
- Twin gas-assisted tailgate struts

Interior Lighting

- Central front courtesy light
- Central rear courtesy light
- Fade up/fade down

Features/Options

		Electric model
	Option code*	SE
Interior Convenience		
Fold-flat front passenger seat with armrest		●
Panoramic sunroof/storage (not available on XL or 7-seat models)	C2K	£840
Child Pack – Rear-view child-minder mirror/Rear side window sunblind	WV6	£250
230-volt electrical accessory socket (in lieu of 12-volt electrical accessory socket)	K15	£120
Electronic parking brake		●
Two foldable tables with cupholders		●
Front-seat back pockets		●

*Optional at extra cost including VAT.

Convenience

Standard Features

Heating and Ventilation

- Air recirculation facility
- Cabin particulate filter – Removes dust, airborne particles and pollen
- Four-speed fan
- Illuminated controls
- Four adjustable facia vents
- Windscreen demist vents
- Side window demist vents
- Rear heating duct

Exterior Convenience

Door mirrors

- Twin electrically adjustable/heated door mirrors

Windows

- Solar heat-absorbing windscreen
- Electrically operated front and rear windows with safety autoreverse and one-touch up/down facility
- Tailgate with heated window and wash/wipe facility

Features/Option

		Electric model
	Option code*	SE
Heating and Ventilation		
Air conditioning		●
Dual-zone electronic climate control	CJ2	£200
Leather-covered steering wheel		●
Exterior Convenience		
Electrically foldable door mirrors		●
Opening tailgate window		●

*Optional at extra cost including VAT.

Exterior Style and Lighting

Standard Features

Exterior Styling

- Chrome-effect front grille bar
- Body-colour door handles
- Body-colour bumpers and sliding rail cover

Exterior Lighting

- Automatic lighting control
- Front fog lights
- LED side repeat indicators
- Lights-on audible warning – When driver’s door is opened an audible warning sounds to alert the lights have been left on

- Manual headlight beam levelling. Use to adapt headlight range to the vehicle load to prevent dazzling.
- Rear fog light
- Reversing light
- Hazard warning lights

Features

		Electric model
		SE
Exterior Styling		
Body-colour side protection mouldings		●
Dark-tinted rear windows		●
Body-colour door mirrors		●
Exterior Lighting		
LED daytime running lights		●

Infotainment

Standard Features

Multimedia with 8-inch touchscreen (IO5)

Standard on Combo-e Life SE models

Onboard features:

- AM/FM stereo radio • DAB Digital radio
- RDS with Traffic Programme • Four speakers

Media connections:

- Apple CarPlay • Android Auto™
- Smartphone projection
- USB connection

Mobile phone portal:

- Bluetooth® connectivity
- Vehicle microphone
- Handsfree calls via steering wheel controls
- Phone book access

Additional features:

- 8-inch colour touchscreen
- Steering wheel mounted audio controls
- Flexible roof-mounted aerial

Vauxhall Connect*

Standard on Combo-e Life SE models

e-Call and b-Call:

Help when you need it, 24/7, 365 days a year, that's what you get with new Vauxhall Connect. In an emergency or breakdown, you'll be put in touch with a trained advisor, with just the touch of a button.

Live Navigation Plus and more:

You can also access live navigation services, receive regular vehicle diagnostic info plus there's a host of remote convenience features available through the MyVauxhall app.

Multimedia Navi Pro with 8-inch touchscreen (IO6)

Optional on Combo-e Life SE models at £460 inc. VAT

Features as Multimedia, with the addition of:

- Satellite navigation system

- **Peace of mind:** emergency call, breakdown call and regular vehicle status and information
- **Convenience:** remote functions (e.g. lock/unlock the door).
- **Our additional services for electric vehicles:** trip planning, remote settings or public charging solutions – we keep you going!
- **Smart driving:** enjoy a relaxed ride thanks to live navigation and trip management
- **Traffic alerts:** Live Navigation Plus introduces speed camera, traffic light camera and accident hotspot alerts

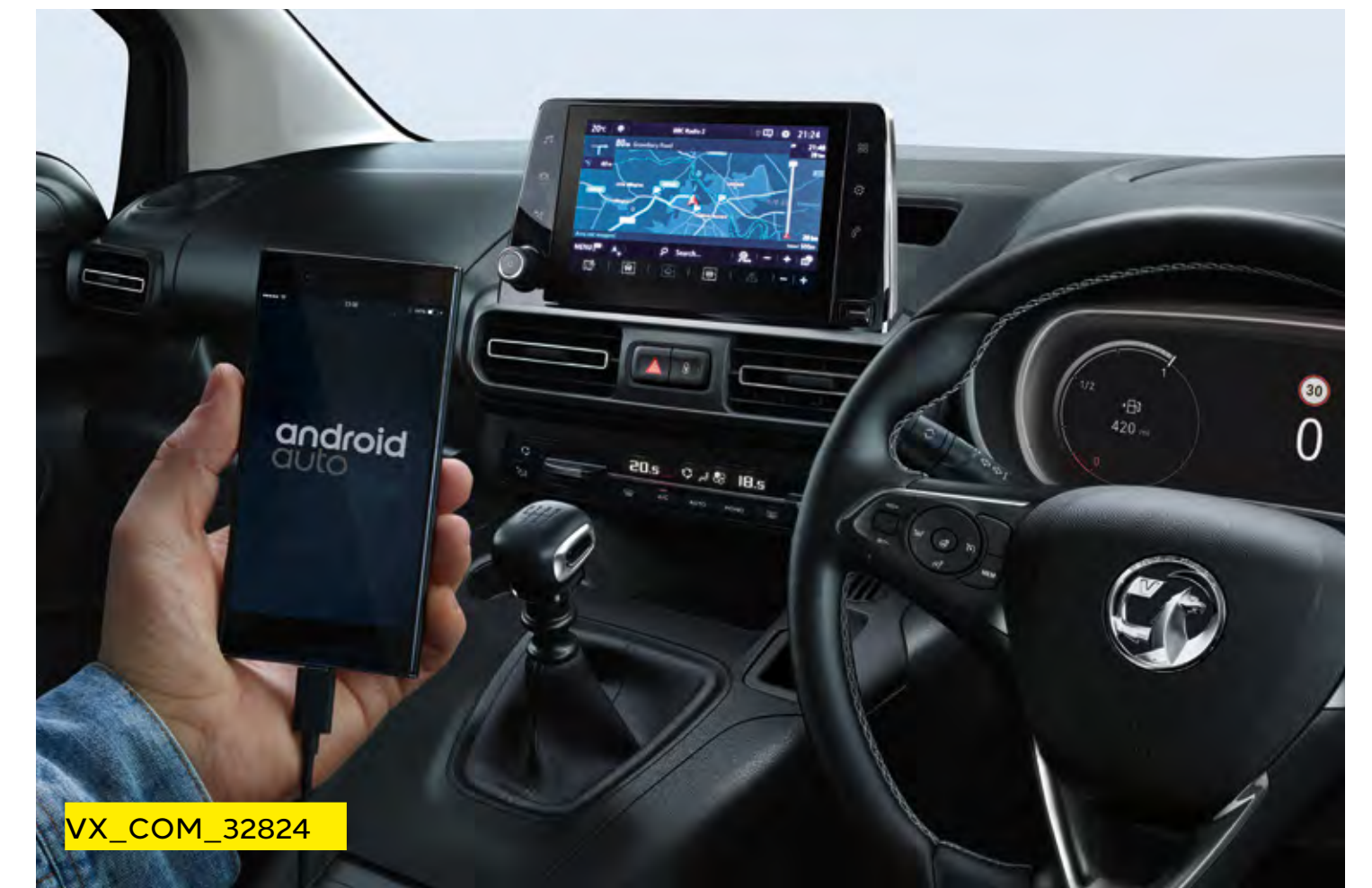

Please note that compatibility and certain functions may be different depending on the type of device and operating system you're using with the Multimedia systems. Apple CarPlay is a trademark of Apple Inc. Apple and iPhone are trademarks of Apple Inc., registered in the U.S. and other countries. Android is a trademark of Google Inc, also registered in the U.S. and other countries. *Services may require a subscription/fee and are subject to mobile network coverage and availability. Live navigation services are included for 3 years and thereafter are subject to an additional subscription fee. Only available on models with satellite navigation.

Please note, Android smartphone projection illustrated on 8-inch colour touchscreen on Multimedia Navi Pro audio unit.

Interior Styling and Comfort

Combo-e Life SE



Steering wheel:

- Three-spoke flat-bottomed design
- Heated leather-covered
- Satin chrome-effect bezel

Seat trim:

- Mistral grey with fabric seat trim inserts

Front seating:

- Driver's seat (six-way adjustable):
 - Height - Reach - Backrest
 - Manual lumbar adjustment - Armrest
 - Under seat storage - Head restraint
- Passenger's Seat (four-way adjustable):
 - Reach - Backrest - Head restraint
 - Fold flat facility

VX_COM_e_32820

Interior Styling and Comfort – Rear seating

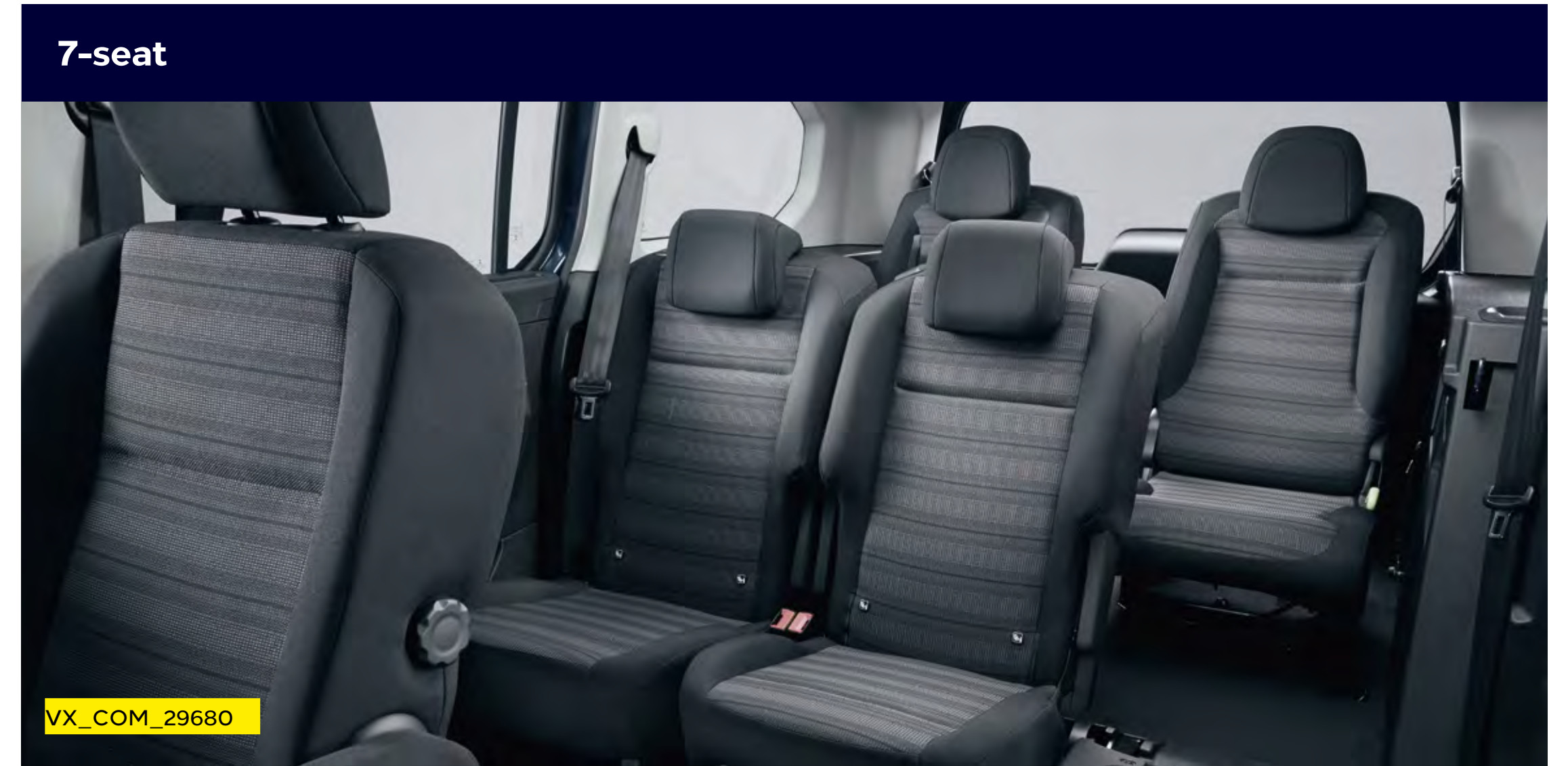

Please note, centre console illustrated not available on UK models.

Features/Option

		Electric model
	Option code*	SE
Rear seating		
Height-adjustable and removable head restraints		●
Second-row three-person layout 60/40 split-folding seats		●
Second-row three-person layout 35/30/35 individual split-folding second-row seats with fold-flat facility	APS	£300
Third-row two-person fixed layout seats (Only available on SE 5-seat models)	ZP7	£600

*Optional at extra cost including VAT.

Effective 13 May 2022

Combo-e Life Model Year 2022C

Exterior Colours

Jade White (G20)*
Solid paint



VX_COM_28545

Cool Grey (GAC)**
Two-coat metallic paint £570



VX_COM_28546

Moonstone Grey (G40)**
Two-coat metallic paint £570



VX_COM_28549

Night Blue (GBT)**
Two-coat metallic paint £570



VX_COM_28550

Quartz Silver (G4I)**
Two-coat metallic paint £570



VX_COM_28547

Copper Metallic (10K)**
Two-coat metallic paint £570



VX_COM_31981

Pearl Black (G70)**
Two-coat metallic paint £570



VX_COM_28548

The colours reproduced may vary slightly from the actual paint colour. As a result they should be used as a guide only. Your Vauxhall Retailer has a comprehensive display of our paint samples.

*Standard exterior paint. ** Optional at extra cost including VAT.

Wheels and Tyres

		Electric model
		SE
 VX_COM_28555_RRZ	16-inch seven-spoke alloy wheels <ul style="list-style-type: none">• 205/60 R 16 tyres• Emergency tyre inflation kit (in lieu of spare wheel)	•

Combo-e Life Specifications*

Single-speed electronic drive selector

As the motor is an all-electric single-speed drive unit, there is no need for multiple gears. Instead, the shifter lets the driver select from the following:

- Park
- Reverse
- Neutral
- Drive
- Braking (for increased regenerative braking)

Drive Mode Selector

The driver can determine the driving style through selecting one of the following modes:

- **Power:** with high power reserves for the highest top speed and torque. Recommended at full capacity
- **Normal:** for a balanced drive that offers a compromise between performance and energy efficiency. WLTP range is validated in this mode
- **ECO:** for maximum range and energy efficiency. The ECO mode deactivates all unnecessary energy-consuming features and reduces the top speed, torque and overall performance

Braking

Energy recuperation

The regenerative braking system works when the vehicle is in motion, energy created by the resistance of the brakes against the drivetrain is converted into DC voltage to partially recharge the battery. The driver can also engage braking mode through the drive selector to increase the level of energy recuperation.

Single foot driving experience

The system not only utilises the energy when the brakes are being used, but also engages when the vehicle is coasting, recovering more energy and enabling single foot driving as the brakes automatically engage when the throttle pedal is released.



VX_COM_e_31963

Drivetrain	Combo-e Life	
CO ₂ emissions	0g/km	
Maximum power	100kW (136PS)	
Maximum torque	260Nm (192lb. ft.)	
Acceleration 0-62mph	11.7 sec	
Maximum speed	84mph	
Transmission	Automatic electric drive with fixed gear ratio	
Service interval	Every 25,000 miles or 2 years (whichever comes sooner) Initial inspection at 12,500 miles or 1 year (whichever comes sooner)	
Electric range	174 miles (WLTP preliminary)	
Weights kg	SE	SE XL
Gross vehicle weight	2366 – 2387	2376 – 2396

The Combo-e Life is a battery electric vehicle requiring mains electricity for charging. Range data given has been determined according to WLTP test procedure methodology. The figures shown are intended for comparability purposes only and should only be compared to other cars tested to the same technical standard. The range you achieve under real world driving conditions will depend upon a number of factors, including but not limited to: the accessories fitted (pre and post registration); charging frequency; personal driving style; vehicle load and route characteristics; variations in weather; heating/air conditioning; pre-conditioning and battery condition. For more information, contact your local Vauxhall Retailer.

*Provisional data.

Combo-e Life Specifications*

Charging

Combo-e Life comes fitted with an 7.4kW on-board charger and mode 3 cable. An 11kW on-board charger is available as an extra cost option.

The charging flap's Padlock LED lights up when the cable is correctly plugged in and locked and then acts as a user interface to show the charging status via coloured LED lights:

- **White:** welcome light that helps to light up the area, especially useful in dark conditions
- **Flashing green:** charging in progress
- **Solid green:** charging complete
- **Solid blue:** delayed charging toggled; changes to flashing green when charging commences
- **Solid red:** malfunction

The driver may also choose from two settings:

- **Immediate charging (the standard setting):** Starts charging as soon as the vehicle is docked for charging
- **Delayed charging:** This is especially useful for when cheaper electric rates are desired, e.g. charging at night. Simply enter a charging start time

Please note, EV range assumes that vehicle has been pre-conditioned prior to journey. This function can be accessed either via MyVauxhall App (standard with all Combo-e Life models or with optional Navi Pro).

Charging		
Supply	Socket	Charge Time (0-100%)
AC current – Domestic 3 pin socket (2.3kW)	Type 2	21h 45m
AC current – Home wallbox or public charger (7kW)	Type 2	7h 30m
AC current – Public charger (11kW)**	Type 2	5h
DC current – Rapid charger (100kW)	CCS	30m (0-80%)

Battery	
Battery capacity	50kWh
AC on-board charger speed (standard)	7.4kW
WLTP Range (Combined)	164-174 miles
WLTP Range (City)	232-257 miles
Energy consumption (Combined low/high)	19.8-21.1kWh/100km
Battery warranty	8 years/100,000 miles/70% capacity



The Combo-e Life is a battery electric vehicle requiring mains electricity for charging. Range data given has been determined according to WLTP test procedure methodology. The figures shown are intended for comparability purposes only and should only be compared to other cars tested to the same technical standard. The range you achieve under real world driving conditions will depend upon a number of factors, including but not limited to: the accessories fitted (pre and post registration); charging frequency; personal driving style; vehicle load and route characteristics; variations in weather; heating/air conditioning; pre-conditioning and battery condition. For more information, contact your local Vauxhall Retailer.

*Provisional data. **Requires optional 11kW on board charger.

Dimensions and Capacities All measurements in mm (inches) unless stated otherwise.

Loadspace Dimensions	Life	Life XL
Maximum load floor length – passenger seat folded	2700 (106.3)	3050 (120.1)
Maximum load length – behind front seats	1880 (74.0)	2230 (87.8)
Maximum load length – behind second-row seats	914 (36.0)	1350 (53.1)
Maximum load length – behind third-row seats	236 (9.3)	418 (16.5) – 566 (22.3)
Maximum load height	1126 (44.3)	1119 (44.0)
Maximum load width	1195 (47.0)	1195 (47.0)
Maximum width between wheel arches	1149 (45.2)	1129 (44.4)
Loading height	584 (23.0)	620 (24.4)
Maximum tailgate aperture width	1087 (42.8) – 1241 (48.9)	1087 (42.8) – 1241 (48.9)
Maximum tailgate aperture height	1126 (44.3)	1126 (44.3)
Maximum height under raised tailgate	1892 (74.5)	1892 (74.5)
Maximum side-access aperture width	640 (25.2) – 745 (29.3)	640 (25.2) – 745 (29.3)
Maximum side-access aperture height	1145 (45.1)	1145 (45.1)
Luggage Capacities* Litres (cu.ft.)		
Behind front-row seats to glassline	1414 (49.9)	1672 (59.0)
Behind front-row seats to roof	2126 (75.1)	2693 (95.1)
Behind second-row seats to glassline	597 (21.1)	850 (30.0)
Behind second-row seats to roof	983 (34.7)	1538 (54.3)
Behind third-row seats	571 (20.2)	806 (28.5)

*Measured using the ECIE method.

Life

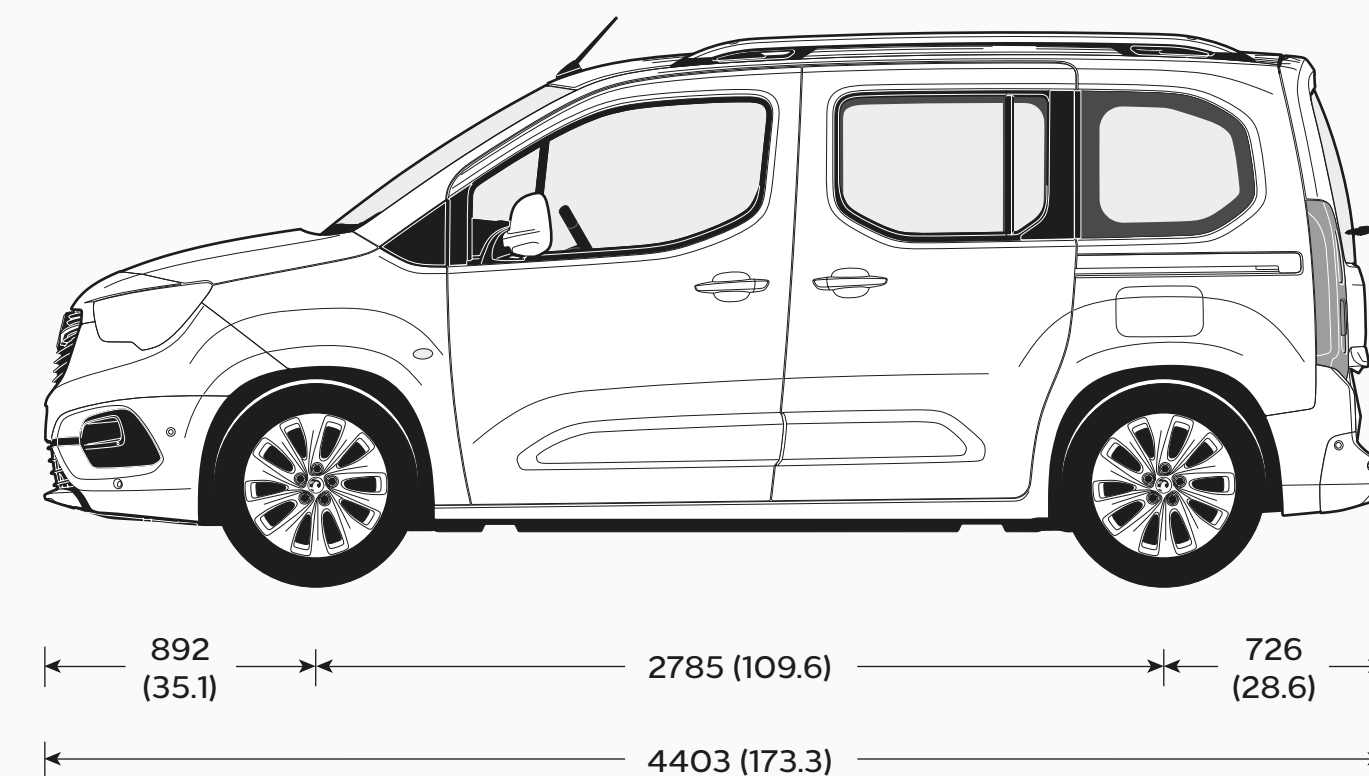
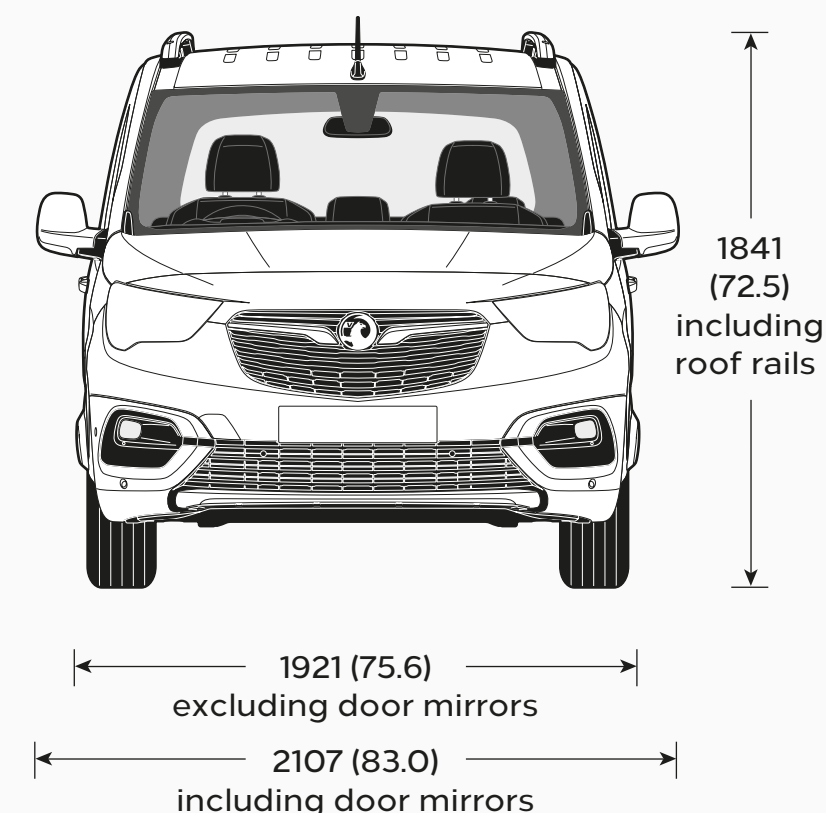

Life XL

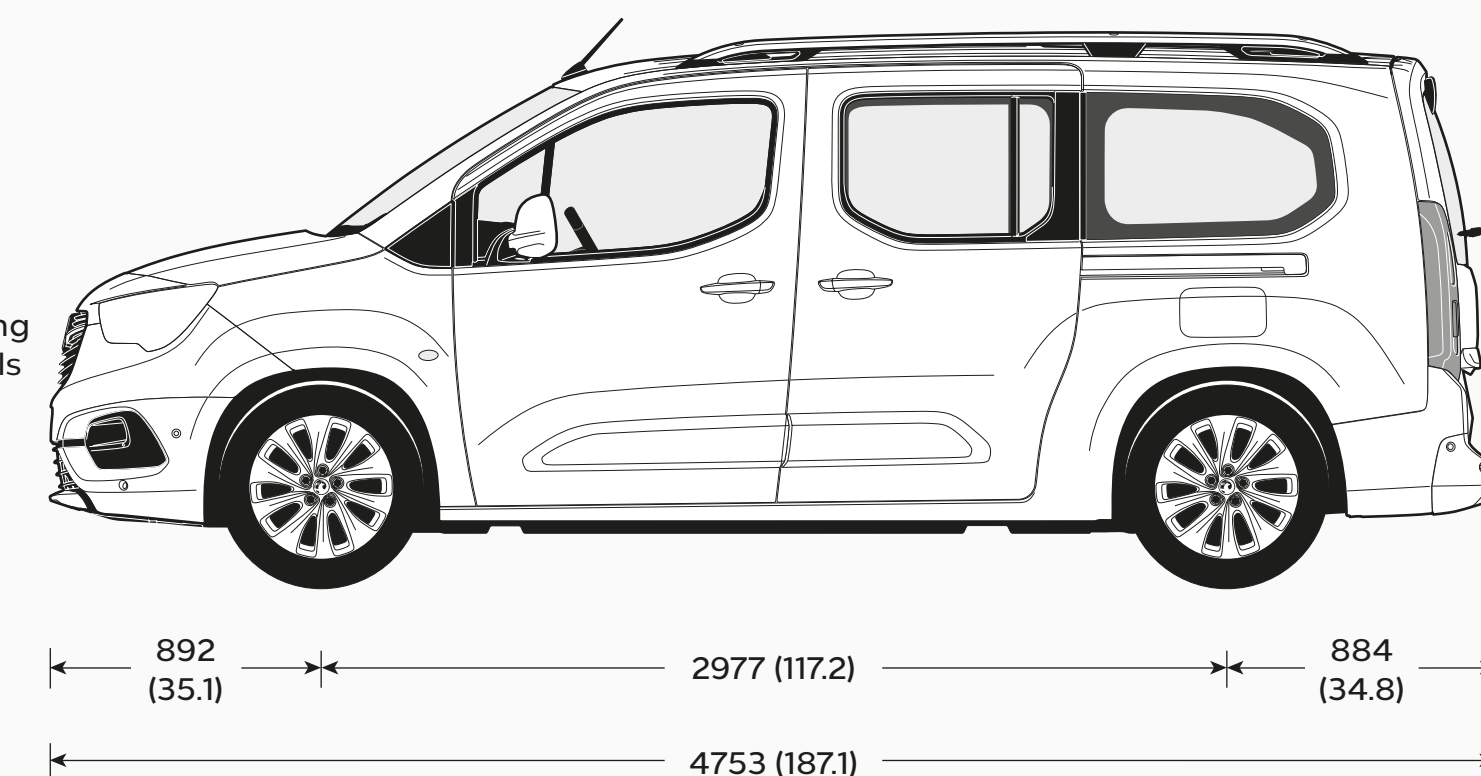
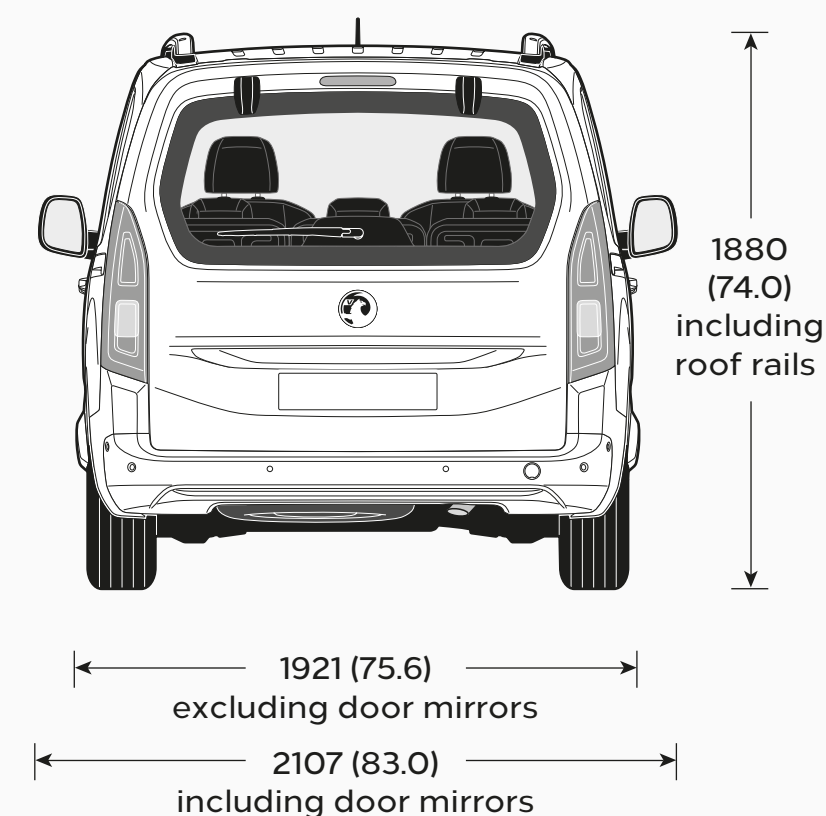

Accessories

Safety	Total (inc. VAT)	Protection	Total (inc. VAT)	Transport solutions	Total (inc. VAT)	Electric	Total (inc. VAT)
Spare wheel kit with 16-inch emergency wheel, tool kit and mounting basket	£247	Carpet mats (set of 4)	£61	Roof base carrier (set of 2 bars)		Mode 2 emergency charging cable (Type G – UK domestic plug)	£584
Philips ADR620 dash cam	£109	Carpet mats for third row seats (set of 2)	£25	– Without roof rails ²	£180	Mode 3 charging cable	
Front parking sensors	£474	Rubber mats (set of 4)	£48	– With roof rails	£219	– 7.4kW	£331
Rear parking sensors	£455	Boot tray	£64	Additional roof base carrier (1 bar)		– 11kW	£371
Child seats ¹		Vertical cargo net	£21	– Without roof rails ²	£105	– 22kW	£438
– Group 0 (0-13kg) – Britax Romer Baby Safe	£239	Dog guard – without sunroof	£282	Roof carriers (requires base carrier)		Cable bag	£49
– ISOFIX Base, Rear-facing for Britax Romer Baby Safe	£251	Dog guard – with sunroof	£248	Roof box – Thule Ocean 80	£164	Mode 2 universal charger UK kit (22kW)	£1,555
– Group 2/3 (15-36kg) – Britax Romer KIDFIX 2 R	£317	Rear splash guards	£97	Roof box – Thule Ocean 200	£374	Accessories for universal charger	
– Group 2/3 (15-36kg) – Britax Romer KIDFIX XP	£352	Comfort		Roof box – Thule Touring 200	£428	– Wall bracket	£105
– Group 3 (22-36kg) – Booster Seat without Seatback	£76	USB charger – 2 front and 2 rear ports	£28	Roof box – Thule Touring 700	£492	– Bag	£65
Safety Pack – first aid kit, hi-vis vest and warning triangle	£16	FlexConnect bracket	£33	Roof box – Thule Motion 800	from £426	– Safety lock	£20
Warning triangle	£9	FlexConnect hook	£37	Bike carrier – Thule FreeRide 532	£81	– Adapter Type 2	£318
Hi-vis safety vest – adult	£4	FlexConnect coat hanger	£41	Bike carrier – Thule Expert 298	£134	– Adapter Type 3c	£358
Hi-vis safety vest – child 3-6 years (42cm)	£4	FlexConnect folding table	£102	Surfboard carrier – Thule 833	£84	– Adapter (various)	£120
Hi-vis safety vest – child 7-12 years (52cm)	£4	FlexConnect iPad Mini holder	£127	Kayak carrier – Thule Hull-a-Port Pro 837	£234		
First aid kit	£15	FlexConnect iPad holder	£106	Ski/snowboard carrier			
Emergency seat belt cutter and hammer	£19	FlexConnect iPad Air holder	£106	– Thule Snow Pack 7324 (4 x pairs)	£147		
Fire extinguisher (1kg) with strap	£23	FlexConnect Samsung Galaxy 10.1 holder	£127	Ski/snowboard carrier			
Spare bulb kit – 11 x high-quality bulbs and 7 x fuses from Philips	£70	Privacy shades (set of 2) for:		– Thule Snow Pack 7326 (6 x pairs)	£265		
		– side rear windows (tilt/turn window)	£59	Towing			
		– side rear windows (electric window)	£59	Swan's neck towing ball and 13-track wiring loom			
		– quarter side rear windows (Life models)	£57	– Life models	£463		
		– quarter side rear windows (Life XL models)	£60	– Life XL models	£463		
		– rear window	£60	Tow bar with removable tow ball and 13-track wiring loom			
		Cupholder organisers	£8-10	– Life models	£571		
		Smoker's kit	£20	– Life XL models	£567		
		Fragrance diffuser	£24	13-pin to 7-pin adaptor	£30		
		Fragrance cartridge (various)	£18				

Please note: Prices shown are fully fitted and painted, where applicable and include VAT. Please check with your local Vauxhall Retailer for details. It is advisable to ensure your insurance policy is adequate to cover additional fitted accessories. Prices correct at time of publication.

¹Restrictions apply to the use of child seats, please consult your vehicle user manual or Vauxhall Retailer. ²A dedicated T-Track adapter (Thule 697-4 or Thule 697-6) is required for the installation of specific roof boxes, contact your local Vauxhall Retailer for details.

Company Car Driver and Fleet Information

Benefit in kind company car taxation*

The car benefit charge will be the car's list price (including VAT, options and accessories fitted, delivery to Retailer and number plates, but excluding Vehicle Excise Duty and new vehicle first registration fee) multiplied by the percentage charge for the CO₂ emissions band in which the car falls (see table opposite). Multiply this figure by your personal income tax rate (20%** for Basic Rate, 40%** for Higher Rate) to calculate your annual benefit in kind tax liability.

Generic example:

ELECTRIC vehicle: 0g/km CO₂

On-the-road RRP	£27,305.00
Deduct: Vehicle Excise Duty	£0.00
New vehicle first registration fee	-£55.00
Effective list price	£27,250.00
Add: Optional two-coat metallic paint	£600.00
List price for tax purposes (P11D value)	£27,850.00
Car benefit charge 2022-23 tax year (2%)	£557.00
Benefit in kind tax liability	
Basic Rate (20%) tax payer	£111.40
Higher Rate (40%) tax payer	£222.80

*Please note this Price Guide provides taxation information as a guide only. Vauxhall does not provide taxation guidance. Drivers should always take professional advice on their own tax position.

**Excludes residents of Scotland.

BiK for Scottish Residents

Effective 6 April 2018 the Scottish Government have introduced their own BiK taxation structure. This only applies to Company Car Drivers that are Scottish taxpayers. HMRC will determine whether or not an individual is a Scottish taxpayer based on where their main place of residence is.

The BiK rates for Scotland are:

- Over £12,570 - £14,732 Starter Rate 19%
- Over £14,732 - £25,688 Basic Rate 20%
- Over £25,688 - £43,662 Intermediate Rate 21%
- Over £43,662 - £150,000 Higher Rate 41%
- Above £150,000 Top Rate 46%

CO ₂ emissions (g/km)	Electric range (miles)	Percentage of cars price to be taxed 2022-23 tax year
0	-	2%
1-50	130+	2%
1-50	70 - 129	5%
1-50	40 - 69	8%
1-50	30 - 39	12%
1-50	<30	14%

To calculate your own personal liability, search: **Vauxhall BiK**, or click the link below:

[Vauxhall BiK Tool](#)

Fleet Toolbox

Discover the facts in our online Toolbox for both Company Car Drivers and Fleet Decision Makers. The Fleet Toolbox has a host of useful calculators, comparators, interactive listings and information.

Search Vauxhall Fleet Tools or click the link below:

[Vauxhall Fleet Tool Box](#)

Contact Vauxhall Fleet

Please contact one of our dedicated sales teams who will be happy to help with your particular enquiry.

Company Car Drivers

Call: 0345 111 2020

Email: company-car@vauxhallinfo.co.uk

Telephone lines are open

- Monday to Friday 8:00am-9:00pm

- Saturday and Sunday 9:00am-6:00pm

Fleet Decision Makers

Depending on the size of your fleet of vehicles, we have a dedicated team to handle your enquiries. The lines are open Monday to Friday excluding Bank Holidays.

1-24 vehicles

Call: 0845 076 2254 (8:30am-5:00pm)

25+ vehicles

Call: 0330 587 8222 (8:30am-5:00pm)

Email: vauxhallfleet@vauxhall.co.uk

Special Vehicles (Police, Fire and Ambulance)

Call: 01582 409999 (8:30am-5:00pm)

Email: vauxhallspecialvehicles@vauxhall.co.uk

Further Information

On-the-road prices

To eliminate uncertainty about hidden costs when buying a new car, Vauxhall publishes on-the-road recommended retail prices (RRP) and these are shown in the pricing tables within this price guide. These prices include VAT, number plates and delivery to Retailer of £700.00 (including £116.67 VAT), 12 months' Government Vehicle Excise Duty (see opposite for details) and the DVLA new vehicle first registration fee of £55.00.*

Please note: The on-the-road recommended retail price (RRP) does not include fuel supplied by the Retailer, motor insurance or any other goods or services supplied by agreement between the Retailer and the customer.

Price protection

Order a new Vauxhall for build in the current model year (as confirmed by your Retailer) for delivery no more than three months in advance and the price you are quoted is the price you pay. This is irrespective of any subsequent price rises between placing your order and delivery of your new car, but you must take delivery as soon as the car is available.

Please note: Price protection does not apply to electric/hybrid models. Vauxhall Motors Limited is not liable for price adjustments caused by Government changes in the rate of VAT (currently 20%), Vehicle Excise Duty, DVLA new vehicle first registration fee or by any other applicable legislation or regulations.

In the event of an accident

Vauxhall Accident Management helps keep you mobile following an accident. Benefits include vehicle recovery, Vauxhall-approved repairs and contacting your insurer. For more details, visit [vauxhall.co.uk/AccidentManagement](https://www.vauxhall.co.uk/AccidentManagement)

Free2Move Lease

Whether you're a big company or a small business looking for vehicle financing, Free2Move Lease, our business finance specialists, can deliver exactly what you need.

Free2Move Lease is one of the UK's largest leasing companies and is also a member of the British Vehicle Rental and Leasing Association (BVRLA).

With over 60,000 vehicles in the Free2Move Lease portfolio, Free2Move Lease is able to offer competitive vehicle solutions. In addition, Free2Move Lease also offer innovative connected management of servicing and maintenance.

For further information, please contact your local Vauxhall Retailer or visit [vauxhall.co.uk/offers-finance/business-leasing.html](https://www.vauxhall.co.uk/offers-finance/business-leasing.html)

Vehicle Excise Duty

The amount of Vehicle Excise Duty (road fund licence) payable on new cars varies depending on the level of carbon dioxide (CO₂) emissions produced by the vehicle. CO₂ emissions are measured in grams per kilometre (g/km) travelled and divided into 13 charging bands shown in the table opposite.

A 'first year rate' of Vehicle Excise Duty is payable on all new cars and in subsequent years the amount payable reverts to the 'standard rate'. From 1 April 2017 the breakpoints for each of these bands have been revised. Also, for vehicles with a list price over £40,000, including factory-fitted options, an additional £335 is payable for the first five years of standard rate payments.

Vehicle Excise Duty*

Band	CO ₂ emissions in grams per kilometre	Standard rate Electric
A	0	£0
B	1 – 50	-
C	51 – 75	-
D	76 – 90	-
E	91 – 100	-
F	101 – 110	-
G	111 – 130	-
H	131 – 150	-
I	151 – 170	-
J	171 – 190	-
K	191 – 225	-
L	226 – 255	-
M	Over 255	-

*Correct at time of issue.

Further Information

Customer Care Commitment

For added peace of mind, Vauxhall has an innovative Customer Care Commitment that offers the following:

- Three-year vehicle warranty consisting of a one-year/unlimited mileage manufacturer's warranty and a second and third year manufacturer's warranty with a 60,000 miles limitation
- Vauxhall Assistance for 12 months from first registration
- Six years' body panel anti-perforation warranty

Please note: Warranty is only available on vehicles sourced from Vauxhall Motors Limited. Terms and conditions apply – please see your Vauxhall Retailer for details.

Vauxhall Assistance

Vauxhall Assistance is provided automatically with every new Vauxhall for 12 months from first registration and covers everything from accident assistance, roadside recovery and 'at home' service to flat tyres. For even more peace of mind, on Combo-e life models the cover is extended* to 8 years or 100,000 miles, whichever comes first. Even more reason for you to stay calm and let us take care of everything should the need arise. With Vauxhall Assistance help is literally just a free** phone call away, 24 hours a day, 365 days a year!

Protecting the environment

Vauxhall's commitment to the environment is demonstrated by our products' many environmental awards. For even more information on Vauxhall's efforts to achieve an environmentally sustainable future, and how to dispose of your end-of-life vehicle, see vauxhall.co.uk/recycling

Vauxhall Care

This all-inclusive service package is available on Vauxhalls under 10 months old (from date of first registration).

This package offers complete peace of mind for the first 3 years of your Vauxhall's life with fixed monthly payments for the plan duration.

- **3 years' Vauxhall servicing** – covers first, second and third annual services. Including a brake-fluid change in the second service
- **2 years' Vauxhall Roadside Assistance** – first year from us
- **First years' MOT[†]** – free of charge by your local Vauxhall Retailer

For full terms and conditions and to sign up, visit: vauxhall.co.uk/vauxhallcare

Vauxhall Service Club

Vauxhall Service Club is available for all Vauxhall owners, and it's free to join. Members benefit from the following:

- 15% off Vauxhall Approved Accessories
- Vauxhall's aged 2-3 Years = 15% off parts and labour
- Vauxhall's aged over 3 Years = 25% off parts and labour
- Half price MOT's (NI excluded)
- Free pre-MOT test inspection (NI only)
- Fixed price AdBlue® Refills
 - Car = £14.99
 - Van = £24.99
- Access to the Vauxhall Accident Management Programme
- Online service booking available 24/7 with servicing appointments available within 3 days – [Book Online](#)
- Collection and delivery/onward mobility options
- Complimentary 'Wash and Vac' with all routine services^{††}
- Vauxhall trained technicians
- Genuine Vauxhall parts
- Minimum 12 months warranty on parts and labour
- Regular newsletters with exclusive offers, discounts and competitions

Terms and conditions apply. To join visit: vauxhall.co.uk/serviceclub

Vauxhall Insurance with added reassurance

Comprehensive cover – Summary of benefits

- Competitive premiums
- Repairs by a Vauxhall-trained technician
- Genuine Vauxhall parts, guaranteed for five years when we repair your car within our Approved Repairer Network
- Free courtesy car as standard when using an Approved Repairer[‡]
- 24 hour claims helpline
- Personal Accident benefit
- Cover for audio equipment
- Windscreen cover

Call for a quote on 0330 678 1130^{‡‡}

For more product information

For further information on the Vauxhall range or location of your nearest Vauxhall Retailer please call 0345 600 1500. Alternatively, details can be found on our website at vauxhall.co.uk

For more information call **0345 600 1500**

For Fleet enquiries call **0330 587 8222**

Discover the full Vauxhall range at **[vauxhall.co.uk](https://www.vauxhall.co.uk)**

Join us online

The invoice price, including delivery to Retailer, factory-fitted options, accessories fitted by the Retailer and number plates, is subject to VAT. Some feature descriptions in this guide may refer to, and some illustrations may show, optional equipment not included in the standard delivery. The information contained in this guide was accurate at the time of publication. We reserve the right to make changes in design and equipment. Please note that Vauxhall Retailers are not the agents of Vauxhall Motors Limited and are not authorised to bind Vauxhall Motors Limited by any specific or implied undertaking or representation. It is advisable to ensure that your motor insurance policy provides adequate cover for additional fitted options and accessories. The colours in this guide are only approximate actual colours. Illustrated optional equipment is available at extra charge. Availability, technical features and equipment provided on our vehicles can vary by model. For precise information on the equipment provided on our vehicles, please contact your local Vauxhall Retailer.

VAUXHALL

Price and Specification Guide
6 April 2022 | Model Year 2022B



Vivaro-e Life

Contents

To find the information you want use the links below to navigate around the guide:

[Choose Your Trim Level](#)

[Range Highlights](#)

[Models](#)

[Prices](#)

[Features/Options](#)

[Infotainment](#)

[Interior Style and Comfort](#)

[Exterior Colours](#)

[Wheels and Tyres](#)

[Specifications](#)

[Dimensions and Capacities](#)

[Accessories](#)

[Company Car Information](#)

[Further Information](#)

Choose Your Trim Level

Vivaro-e Life Combi



VX_VIVL_e_33029

The Vivaro-e Life Combi combines real-world versatility with an innovative all-electric drivetrain. Making it perfect for use as a work transportation vehicle or taxi.

Vivaro-e Life Elite



VX_VIVL_e_32755

Vivaro-e Life Elite is your more premium all-electric people carrier, with plenty of great features and top of the range tech.

New Vivaro-e Life Range Highlights

Combi

Standard features include:

- Multimedia system
 - 7-inch colour touchscreen
 - AM/FM/DAB digital radio
 - Bluetooth®
 - USB connection
- Four speakers
- Vauxhall Connect
- 16-inch steel wheels
- Air conditioning
- Multi-function trip computer
- Electronic parking brake
- Dual front passengers' seat with underseat storage
- Second-row three-passenger 60/40 split bench seat with tilt function
- Third-row three-passenger fixed bench seat
- Electrically adjustable/heated door mirrors
- Electrically operated front windows
- Nearside and offside sliding side-access doors with fixed windows
- Tailgate with wash/wipe and heated rear window
- Side-protection mouldings
- Six airbags
- Height-adjustable lap and diagonal inertia-reel seatbelts
- Electronic stability programme with traction control
- Anti-lock braking system
- Tyre pressure monitoring system
- Hill start assist
- Daytime running lights
- Remote control central deadlocking
- Selective door locking
- Electronic engine deadlock immobiliser
- Remote control security alarm system

Elite – MY22B specification shown*

Features over Combi models:

- Multimedia Navi Pro system
 - Satellite Navigation
 - Voice control
 - Two USB connections
- Ten speakers
- 17-inch bi-colour alloy wheels
- Electrically operated sliding side-access doors
- Leather seat trim
- Leather-covered steering wheel
- Heated power driver's seat and heated front passenger's seat with massage facility
- Driver's seat memory functions
- Dual-zone electronic climate control with rear air conditioning
- Roof-mounted rear heater controls
- Rear parcel shelf
- Luggage floor net
- Second-row three-passenger foldable 60/40 split bench seat
- Third-row three-passenger foldable 60/40 split individually sliding bench/single seat
- Rear seat back tables
- Rear-view child-minder mirror
- Rear side window blinds
- Body-colour front bumper
- Body-colour rear corner bumper with black centre section
- Chrome-effect front grille
- Front fog lights
- Panoramic rear-view camera
- Rain-sensitive windscreen wipers
- Automatic anti-dazzle rear-view mirror
- LED daytime running lights
- Dark-tinted rear windows
- Electrically folding door mirrors
- Rear parking distance sensors
- Panoramic glass roof
- Ten airbags
- Tailgate with separate opening rear window
- Keyless entry and start
- Lane departure warning with lane keep assist
- Speed sign recognition
- Driver drowsiness system
- White text instrument panel
- High beam assist

Vivaro-e Life Combi



VX_VIVL_e_33029

**Combi M
(Medium) 9-seater**

**OTR
£30,295***

Infotainment:

- Multimedia system
 - 7-inch colour touchscreen
 - AM/FM/DAB digital radio
 - Bluetooth®
 - USB connection
- Four speakers
- Vauxhall Connect

Interior convenience/styling:

- Air conditioning
- Multi-function trip computer
- Electronic parking brake
- Dual front passengers' seat with underseat storage
- Second-row three-passenger 60/40 split bench seat with tilt function
- Third-row three-passenger fixed bench seat

Exterior convenience/styling:

- 16-inch steel wheels
- Electrically adjustable/heated door mirrors
- Electrically operated front windows
- Nearside and offside sliding side-access doors with fixed windows
- Tailgate with wash/wipe and heated rear window
- Side-protection mouldings

Safety/security:

- Six airbags
- Height-adjustable lap and diagonal inertia-reel seatbelts
- Electronic stability programme with traction control
- Anti-lock braking system
- Tyre pressure monitoring system
- Hill start assist
- Daytime running lights
- Remote control central deadlocking
- Selective door locking
- Electronic engine deadlock immobiliser
- Remote control security alarm system

**Combi L
(Long) 9-seater**

**OTR
£30,495***

*Price shown is after allowing for PiCG (Plug-in Car Grant).

Vivaro-e Life Elite

MY22B specification shown (from February production)



VX_VIVL_e_32755

Elite M (Medium) 8-seater

OTR
£49,105

Infotainment:

- Multimedia Navi Pro system
 - Satellite Navigation
 - 7-inch colour touchscreen
 - AM/FM/DAB digital radio
 - Bluetooth®
 - Voice control
 - Two USB connections
- Ten speakers
- Vauxhall Connect

Interior convenience/styling:

- Dual-zone electronic climate control with rear air conditioning
- Multi-function trip computer
- Second-row three-passenger foldable 60/40 split bench seat
- Third-row three-passenger foldable bench seat
- Leather seat trim
- Leather-covered steering wheel
- Heated power driver's seat and heated front passenger's seat with massage facility
- Driver's seat memory functions
- Roof-mounted rear heater controls
- Electronic parking brake
- Rear parcel shelf
- Luggage floor net
- Rear seat back tables
- Rear-view child-minder mirror
- Rear side window blinds
- Automatic anti-dazzle rear-view mirror

Exterior convenience/styling:

- 17-inch bi-colour alloy wheels
- Visibility Pack

- Electrically adjustable/heated/foldable door mirrors
- Electrically operated front windows
- Tailgate with wash/wipe and heated opening rear window
- Side-protection mouldings
- Electrically operated sliding side-access doors
- Body-colour front bumper
- Body-colour rear corner bumper with black centre section
- Chrome-effect front grille
- Front fog lights
- Panoramic rear-view camera
- Dark-tinted rear windows
- Rear parking distance sensors
- Panoramic glass roof
- Keyless entry and start

Safety/security:

- Driver Assistance Pack
- Ten airbags
- Height-adjustable lap and diagonal inertia-reel seatbelts
- Electronic stability programme with traction control
- Anti-lock braking system
- Tyre pressure monitoring system
- Hill start assist
- LED daytime running lights
- Selective door locking
- Electronic engine deadlock immobiliser
- Remote control security alarm system
- Keyless entry and start

Elite L (Long) 8-seater

OTR
£49,465

Effective 6 April 2022

Vivaro-e Life Model Year 2022B

New Vivaro-e Life Prices

	Pack Code	Orderable Option Code	Propulsion	Price (£)	VAT (£)	Total (£)	On-the-road RRP before PiCG (£)	On-the-road RRP after PiCG (£)	Financial Year 2022/23 BiK 20% (£)	WLTP Combined CO ₂ (g/km)* - pack code	Insurance groups
Combi M (Medium) 9-seater											
100kW (136PS) auto – 50kWh battery	8F06 9CQ1	XiFC	Electric	25,866.67	5,173.33	31,040.00	31,795.00	30,295.00	10.57	0	N/A
Combi L (Long) 9-seater											
100kW (136PS) auto – 50kWh battery	8F06 9CQ1	XiFF	Electric	26,033.33	5,206.67	31,240.00	31,995.00	30,495.00	10.63	0	N/A
Elite M (Medium) 8-seater											
100kW (136PS) auto – 50kWh battery	8RZ6 9CQ1	XiFC	Electric	40,291.67	8,058.33	48,350.00	49,105.00	N/A*	16.33	0	tba
Elite L (Long) 8-seater											
100kW (136PS) auto – 50kWh battery	8RZ6 9CQ1	XiFF	Electric	40,591.67	8,118.33	48,710.00	49,465.00	N/A*	16.47	0	36E

WLTP figures are based on a configured vehicle as per pack code for UK with no options fitted.

*The Vivaro-e Life is a battery electric vehicle requiring mains electricity for charging. Range data given has been determined according to WLTP test procedure methodology. The figures shown are intended for comparability purposes only and should only be compared to other cars tested to the same technical standard. The range you achieve under real world driving conditions will depend upon a number of factors, including but not limited to: the accessories fitted (pre and post registration); charging frequency; personal driving style; vehicle load and route characteristics; variations in weather; heating/air conditioning; pre-conditioning and battery condition. For more information, contact your local Vauxhall Retailer.

Please note: On-the-road recommended retail prices (RRP) include number plates and delivery to Retailer of £700.00 (inc. £116.67 VAT), 12 months' Vehicle Excise Duty and new vehicle first registration fee of £55.00. Excludes fuel and insurance. Company Car Benefit in Kind (BiK) rates are monthly based on the standard paint price. Price has been calculated using manufacturer estimates and includes a £1,500.00 OZEV grant which has been deducted from the price of the vehicle (OZEV Grant not available in the Isle of Man). The grant is a government incentive and is subject to withdrawal prior to delivery of your vehicle. Retailers may be required to carry out more than one credit check during the course of the order process. You may be required to place a deposit when placing your order with your supplying Retailer. In the event of a price change, deposit refunds will be governed by your supplying Retailer's policy and as such must be discussed with the supplying Retailer.

Vivaro-e Life is not covered by our Price Protection Guarantee. See 'Further Information' page for details.

*Elite is not eligible for the plug-in car grant.

Safety

Standard Features – The following features are standard across the entire Vivaro-e Life range.

Airbags

- Driver's airbag • Front passenger's airbag
- Two front seat side-impact airbags
- Full-size curtain airbags for driver and front and outer rear seat passengers
- Full-length curtain airbags second- and third-row seating (Long wheel base models only)

Seating

- Height-adjustable front seat head restraints

Seatbelts

- Lap and diagonal inertia-reel seatbelts (height-adjustable front)
- Front body-lock diagonal seatbelt pretensioner system.
- Drivers and front passenger's lap belt pretensioner system
- Front seatbelt force limiters
- 'Seatbelt unfastened' audible warning and warning light

Braking

- Anti-lock Braking System (ABS)
- Emergency brake assist – When emergency braking is detected the vehicle automatically applies the maximum possible braking assistance

- Electronic brakeforce distribution – Automatically apportions the optimum braking force to each wheel
- Hill start assist – Briefly maintains rear brake pressure to stop the vehicle rolling back on an incline

Child safety

- Deactivation switch for front passenger's front and side-impact airbags
- ISOFIX child seat mountings incorporating top tether anchor points located on second-row rear seats (does not include child seat) – Allows ISOFIX child safety seats to be securely fixed into the car. The ISOFIX mounting system reduces forward movement in an accident and makes the child seat easier to install
- Child-proof locks on rear doors

Stability

- Electronic Stability Programme (ESP) – ESP monitors many different inputs to determine when the car starts to lose traction, it can then immediately respond by varying the brake pressure between up to three wheels and adjust the engine output to help correct the loss of traction and improve stability

Additional ESP features

- Traction control
- Cornering brake control
- Straight line stability control

Tyre pressure

- Tyre pressure monitoring system

Vauxhall driver assistance systems are intended to support the driver within the system-imminent limitations. The driver remains responsible for the driving task at all times.



Driver drowsiness system (see next page for feature description).



ISOFIX child seat mountings.



Lane departure warning (see next page for feature description).

Driver Assistance

Standard Features – The following features are standard across the entire Vivaro-e Life range.
Specific features by model are outlined in the separate tabular information.

Steering

- Speed sensitive electrically assisted power steering
- Reach and rake adjustable steering

Wipers

- Two-speed windscreen wipers with variable intermittent wipe
- Intermittent rear window wash/wipe

Model Specific Features/Options

	Option code*	Electric models	
		Combi	Elite
Driver Assistance			
Visibility Pack – Solar heat-absorbing windscreen/Rain-sensitive windscreen wipers			●
Rear parking distance sensors**	UD7	£220	●
Electronic parking brake		●	●
Automatic transmission with e-toggle shift		●	●
7.4kW single-phase on-board charger with 6m mode-3 7kW cable (added at POE)		●	●
11kW three-phase on-board charger with mode-3 22kW cable (added at POE)	K29	£360	£360
Driver Assistance Pack – Lane departure warning/Speed sign recognition/Driver drowsiness system /White text Instrument panel/High beam assist			●
Panoramic rear-view camera – Requires rear parking distance sensors (UD7)**	UL3	£840	●

*Optional at extra cost including VAT. **Please note, due to ongoing shortages in the global supply chain, some Vivaro-e Life models may be built with reduced levels of standard equipment and option availability. Please consult your supplying Retailer for further details.

Driver Information and Security

Standard Features – The following features are standard across the entire Vivaro-e Life range. Specific features by model are outlined in the separate tabular information.

Driver Information

Instrumentation

(see specifications for further details)

- Speedometer

Multi-function trip computer

- Trip odometer
- Vehicle range
- Average speed
- Driving time

Central facia display

(format dependent on infotainment unit)

- Audio information
- Digital clock with automatic RDS time adjustment
- Outside air temperature with ice warning function
- Additional features dependent on infotainment unit (see infotainment for details)

Security

- Electronic engine deadlock immobiliser
- Steering column lock
- Anti-theft spare wheel cradle
- Visible Vehicle Identification Number (VIN)
- Locking wheel bolts with alloy wheels

Remote control security alarm system

- Remote control door locking
- Two keys with integral remote
- Door deadlocks
- Selective door locking
- System monitors doors, tailgate, bonnet and the passenger compartment

Model Specific Feature

	Electric models		
	Option code	Combi	Elite
Security			
Keyless entry and start			●

Convenience

Standard Features – The following features are standard across the entire Vivaro-e Life range. Specific features by model are outlined in the separate tabular information.

Interior Convenience

- Reach and rake-adjustable steering wheel
- Facia-mounted gear lever
- Floor-mounted handbrake
- 12v socket in saloon area

Interior Storage

- Upper glovebox
- Open lower glovebox with 12v socket and aux-in facility
- Lower shelf
- A4 storage compartment on top of facia
- Open storage compartments in facia
- Two drinks holders on top of facia
- Storage pocket in front of gear lever
- Front door pockets with three separate compartments

Model Specific Features

	Option code	Electric models	
		Combi	Elite
Interior Convenience and Storage			
Luggage area restraint net and cover			●
Luggage floor net			●
Rear seat back tables			●
Rear-view child-minder mirror			●
Rear side-window blinds			●
Torch stowed in rear luggage area panel			●
220 volt socket behind driver's seat			●
Automatic anti-dazzle rear-view mirror			●
Electrically foldable door mirrors			●

Convenience

Standard Features – The following features are standard across the entire Vivaro-e Life range. Specific features by model are outlined in the separate tabular information.

Heating and Ventilation

- Air recirculation facility
- Pollen filter
- Illuminated controls
- Chilled glovebox facility

Exterior Convenience

- Nearside and offside sliding side-access doors with fixed windows

Door mirrors

- Foldable electrically adjustable/heated door mirrors

Windows

- Electrically operated front windows with one-touch up/down facility
- Tailgate with heated windows and wash/wipe facility

Model Specific Features/Options

	Option code*	Electric models	
		Combi	Elite
Heating and Ventilation			
Air conditioning		●	
Dual-zone electronic climate control with rear air conditioning and roof mounted controls			●
Heated front seats			●
Exterior Convenience			
Electrically operated sliding side-access doors			●
Opening tailgate window			●
Rear doors – 90°/180° opening	J1X	£240	
Vertical safety net	APT		£120

*Optional at extra cost including VAT.

Exterior Style and Lighting

Standard Features – The following features are standard across the entire Vivaro-e Life range. Specific features by model are outlined in the separate tabular information.

Exterior Styling

- Side protection mouldings

Exterior Lighting

- Daytime running lights
- Reversing lights
- Hazard warning lights

- Rear fog lights
- High-level brake light
- Side-repeat indicators
- Lights-on audible warning

Model Specific Features/Options

	Option code*	Electric models	
		Combi	Elite
Exterior Style			
Body-colour front bumper			●
Body-colour rear corner bumper with black centre section (Elite L models only)			●
Body-colour mirror housings and door handles			●
Body-colour side-protection mouldings			●
Chrome-effect front grille			●
Full-length panoramic glass sunroof with manually-sliding sunblinds			●
Dark-tinted rear windows	AKO	£120	●
Connector for conversions	WRF	£108	
Exterior Lighting			
Front fog lights			●
LED daytime running lights			●

*Optional at extra cost including VAT.

Infotainment

Standard Features

Multimedia with 7-inch touchscreen (IO5)

Standard on Combi models

Onboard features:

- 7-inch colour touchscreen
- AM/FM stereo radio
- DAB Digital radio
- RDS with Traffic Programme
- Four speakers

Media connections:

- USB connection
- Bluetooth® A2DP audio streaming (Advanced Audio Distribution Profile)

Mobile phone portal:

- Bluetooth® connectivity
- Vehicle microphone
- Phone book access – Contacts/last calls/missed calls etc. are mirrored on the display and are easily navigated using the touchscreen (features dependent on mobile phone)
- Smartphone interface – Apple CarPlay/Android Auto™

Additional features:

- Flexible roof-mounted aerial

Multimedia Navi Pro with 7-inch touchscreen (IO6)

Standard on Elite models and optional at extra cost on Combi models at £650 inc. VAT

Features as Multimedia, with the addition of:

- Satellite navigation system • 2D/3D street level mapping
- European coverage • Points-of-interest search
- Eco routing • Map updates via USB
- Second USB connection
- Three years subscription to TomTom Live*
- On-line navigation services provided by TomTom®
- Vivaro-e shortcut key – Energy flow visualization
 - Energy stats visualization
 - Deferred charging options
 - Thermal pre-conditioning
 - Battery/range check
- Ten speakers

Vauxhall Connect**

e-Call and b-Call:

Help when you need it, 24/7, 365 days a year, that's what you get with new Vauxhall Connect. In an emergency or breakdown, you'll be put in touch with a trained advisor, with just the touch of a button.

Live Navigation Plus and more:

You can also access live navigation services, receive regular vehicle diagnostic info plus there's a host of remote convenience features available through the MyVauxhall app.

- **Peace of mind:** emergency call, breakdown call and regular vehicle status and information
- **Convenience:** remote functions (e.g. lock/unlock the door).
- **Our additional services for electric vehicles:** trip planning, remote settings or public charging solutions – we keep you going!
- **Smart driving:** enjoy a relaxed ride thanks to live navigation and trip management
- **Traffic alerts:** Live Navigation Plus introduces speed camera, traffic light camera and accident hotspot alerts



Please note that compatibility and certain functions may be different depending on the type of device and operating system you're using with the Multimedia systems. Apple CarPlay is a trademark of Apple Inc. Apple and iPhone are trademarks of Apple Inc., registered in the U.S. and other countries. Android is a trademark of Google Inc, also registered in the U.S. and other countries. *Additional terms and conditions apply to connected services, including customer acceptance of location sharing prior to activation. **Services may require a subscription/fee and are subject to mobile network coverage and availability. Standard on Nav models only. Live navigation services are included for 3 years and thereafter are subject to an additional subscription fee.

Interior Styling and Comfort

Combi



Steering wheel:

- Three-spoke design
- Satin chrome-effect bezel

Facia and door trim:

- Mistral Black/Grey

Front seating:

- Driver's seat (six-way adjustable):
 - Height – Reach – Backrest
 - Manual lumbar adjustment
 - Under seat storage – Head restraint
- Dual front passenger's seats
 - Fixed position bench seat and backrest
 - Height-adjustable front padded head restraints

Seat trim:

- Curitiba Tritone Grey fabric seat trim

Elite



Steering wheel:

- Leather-covered
- Three-spoke design
- Satin chrome-effect bezel

Facia and door trim:

- Mistral Black with decor insert

Front Seating:

- Power driver's seat with memory and massage functions (six-way adjustable):
 - Height – Reach – Backrest
 - Lumbar adjustment – Armrest
 - Under seat storage – Head restraint
- Passenger's Seat with massage functions (four-way adjustable)
 - Reach – Backrest
 - Head restraint – Armrest

Seat trim:

- Carla black leather seat trim

Interior Styling and Comfort – Rear seating

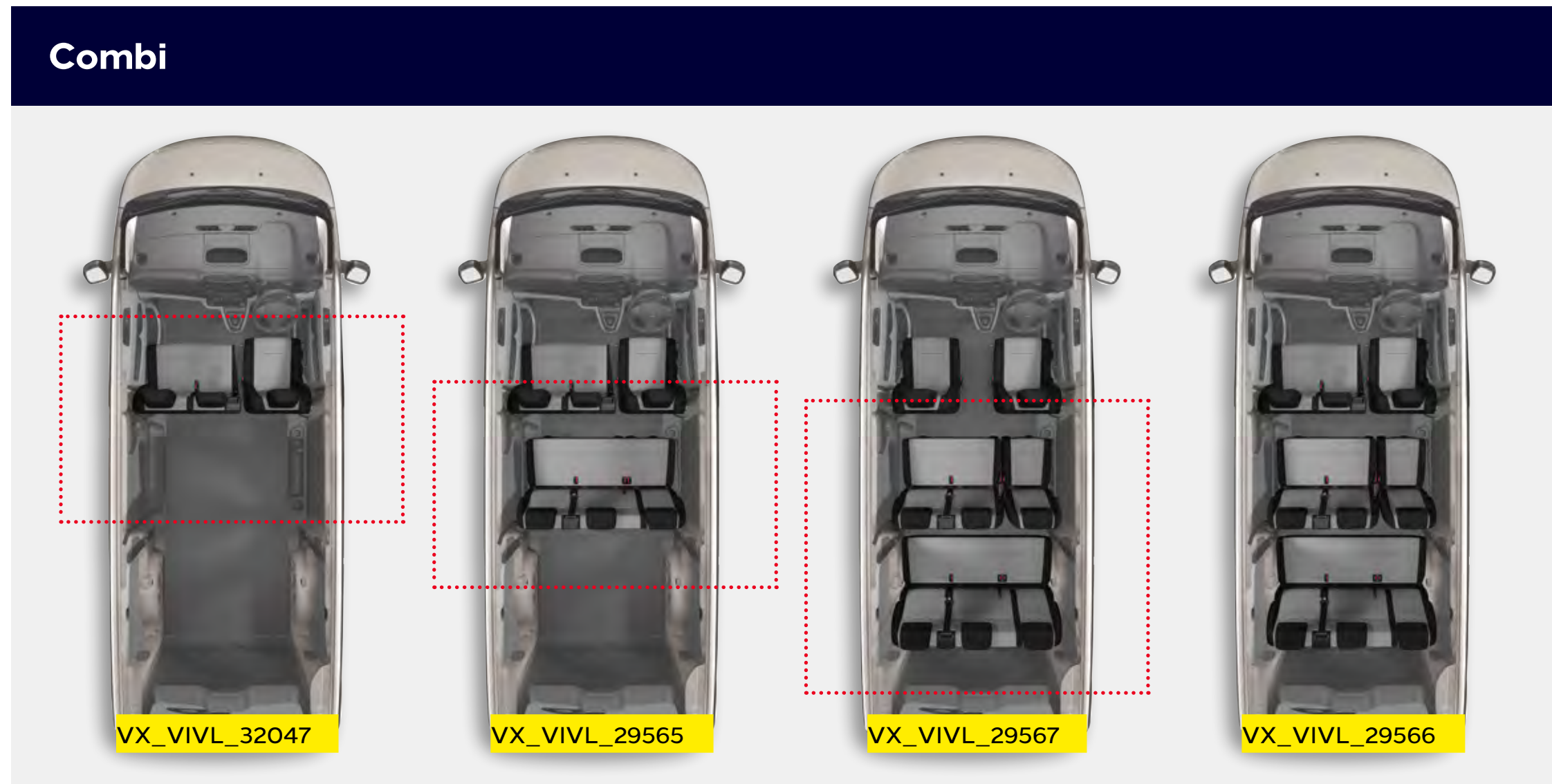

Model Specific Features/Options

	Option code*	Electric models	
		Combi	Elite
Rear seating			
Second-row three-passenger 60/40 split bench seat with tilt function		●	
Third-row three-passenger fixed bench seat		●	
Second-row three-passenger foldable 60/40 split bench seat			●
Third-row three-passenger foldable 60/40 split individually sliding bench/single seat			●
Two removable and reversible individual second-row seats	AW2		£800
Foldable table on rails – Only in conjunction with AW2	TRD		£495

*Optional at extra cost including VAT.

Exterior Colours

Jade White (G2o)*
Solid paint



Moonstone Grey (G4o)**
Two-coat metallic paint £600



Quartz Grey (G4I)**
Two-coat metallic paint £600



Cool Grey (GAC)†
Two-coat metallic paint £600



Rich Oak Brown (GoJ)†
Two-coat metallic paint £600

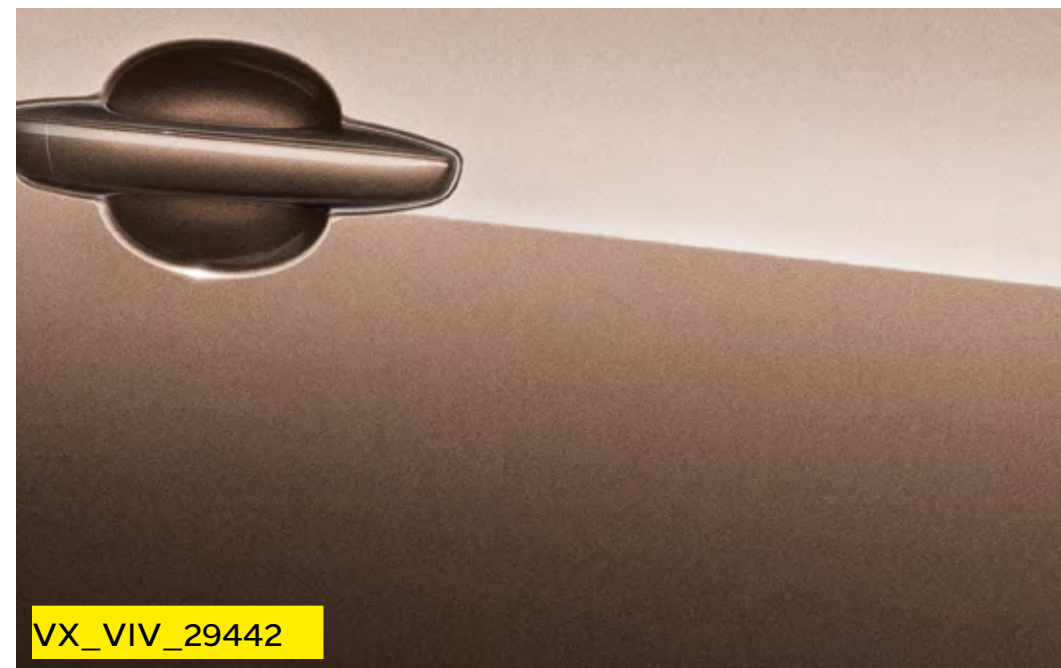

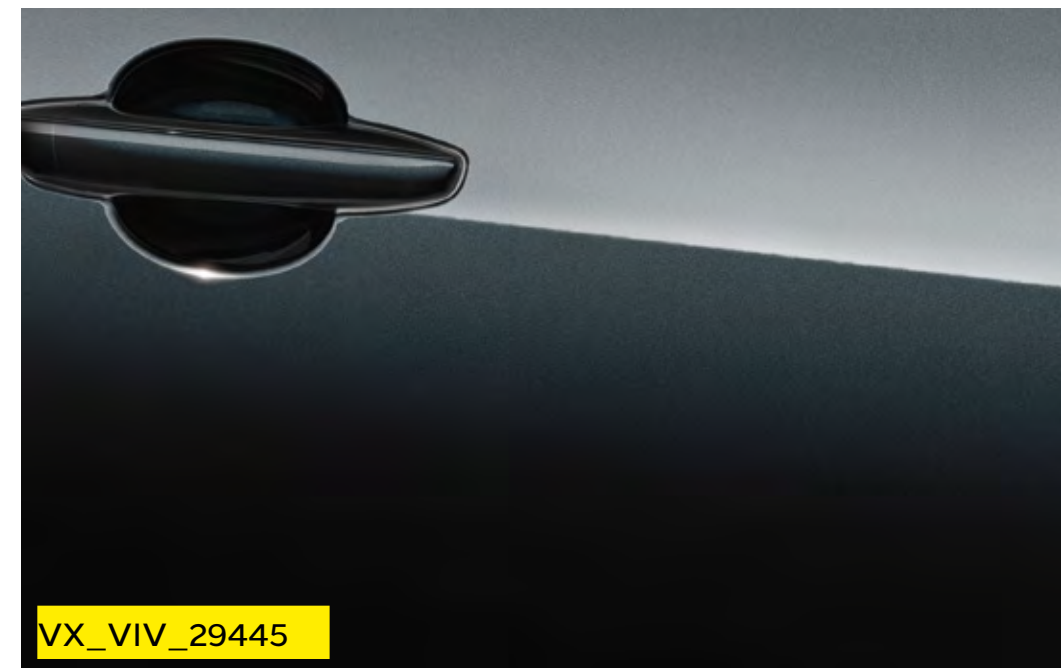

Pearl Black (G7o)**
Two-coat metallic paint £600



The colours reproduced may vary slightly from the actual paint colour. As a result they should be used as a guide only. Your Vauxhall Retailer has a comprehensive display of our paint samples.

*Standard exterior paint for **Optional at extra cost including VAT. †Optional at extra cost including VAT. Not available on Combi models.

Wheels and Tyres

		Electric models		
		Option code	Combi	Elite
 <p>VX_VIV_29655</p>	<p>16-inch steel wheels with centre cap</p> <ul style="list-style-type: none"> • 215/65 R 16 tyres • Emergency tyre inflation kit (in lieu of spare wheel) 		•	
 <p>VX_VIV_29648_WQX</p>	<p>17-inch diamond-cut alloy wheels</p> <ul style="list-style-type: none"> • 215/60 R 17 tyres • Emergency tyre inflation kit (in lieu of spare wheel) 			•

Specifications*

Single-speed electronic drive selector

As the motor is an all-electric single-speed drive unit, there is no need for multiple gears. Instead, the shifter lets the driver select from the following:

- Park
- Reverse
- Neutral
- Drive
- Braking (for increased regenerative braking)

Drive Mode Selector

The driver can determine the driving style through selecting one of the following modes:

- **Power:** with high power reserves for the highest top speed and torque. Recommended at full capacity
- **Normal:** for a balanced drive that offers a compromise between performance and energy efficiency. WLTP range is validated in this mode
- **ECO:** for maximum range and energy efficiency. The ECO mode deactivates all unnecessary energy-consuming features and reduces the top speed, torque and overall performance

Braking

Energy recuperation

The regenerative braking system works when the vehicle is in motion, energy created by the resistance of the brakes against the drivetrain is converted into DC voltage to partially recharge the battery. The driver can also engage braking mode through the drive selector to increase the level of energy recuperation.

Single foot driving experience

The system not only utilises the energy when the brakes are being used, but also engages when the vehicle is coasting, recovering more energy and enabling single foot driving as the brakes automatically engage when the throttle pedal is released.

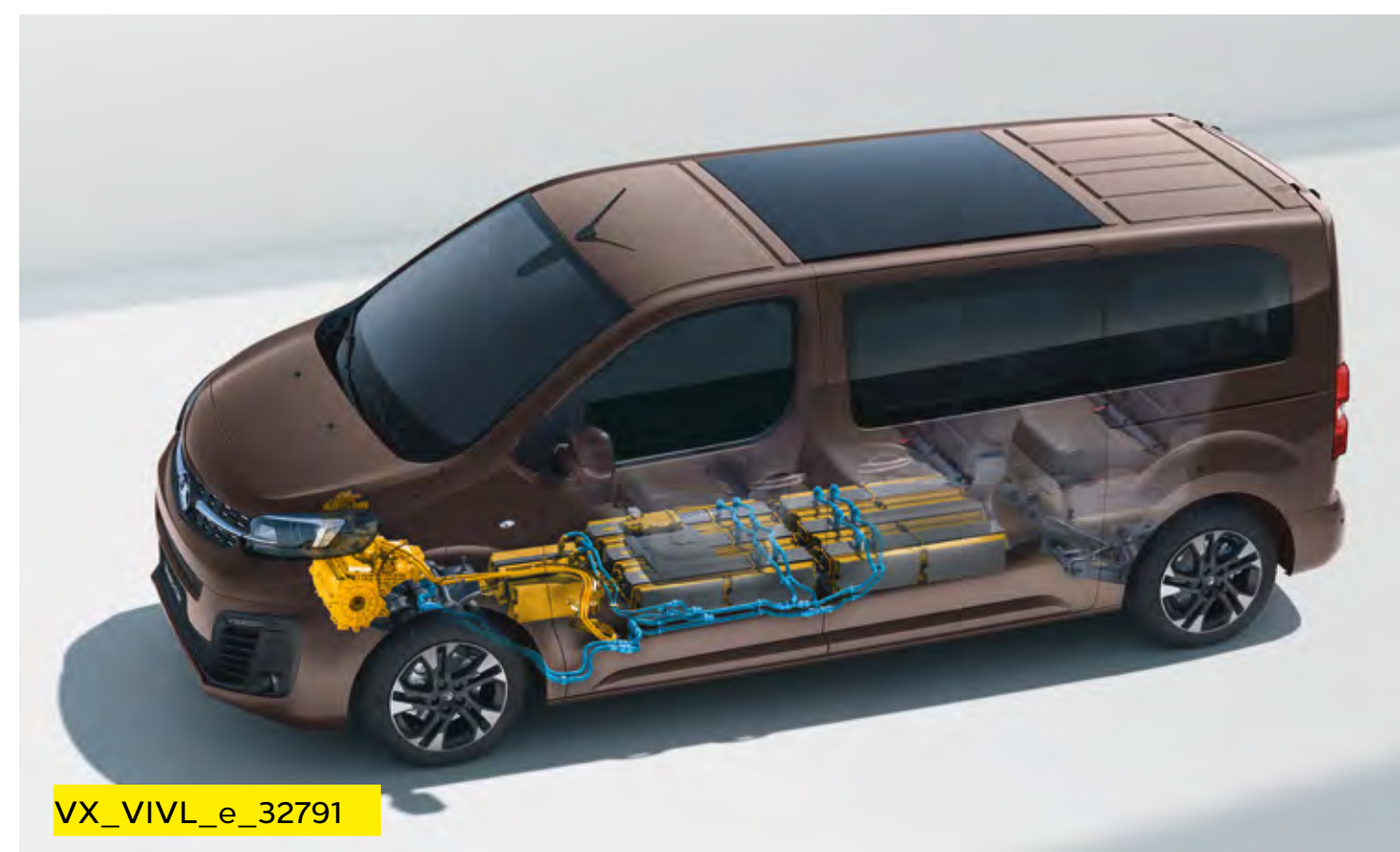

Drivetrain	Vivaro-e Life	
CO ₂ emissions	0g/km	
Maximum power	100/136kW/PS	
Maximum torque	260/192Nm/lb. ft.	
Acceleration 0-62mph	13.1 sec	
Maximum speed	81mph	
Transmission	Automatic electric drive with fixed gear ratio	
Service interval	Every 25,000 miles or 2 years (whichever comes sooner). Initial inspection at 12,500 miles or 1 year (whichever comes sooner)	
Electric range	143 miles (WLTP preliminary)	
Weights kg	L Combi 9-seater	L Elite 8-seater
Gross vehicle weight	3030	2965

The Vivaro-e Life is a battery electric vehicle requiring mains electricity for charging. Range data given has been determined according to WLTP test procedure methodology. The figures shown are intended for comparability purposes only and should only be compared to other cars tested to the same technical standard. The range you achieve under real world driving conditions will depend upon a number of factors, including but not limited to: the accessories fitted (pre and post registration); charging frequency; personal driving style; vehicle load and route characteristics; variations in weather; heating/air conditioning; pre-conditioning and battery condition. For more information, contact your local Vauxhall Retailer.

*Provisional data.

Specifications*

Charging

Vivaro-e Life comes fitted with an 7.4kW on-board charger and mode 3 cable. An 11kW on-board charger is available as an extra cost option.

The charging flap's Padlock LED lights up when the cable is correctly plugged in and locked and then acts as a user interface to show the charging status via coloured LED lights:

- **White:** welcome light that helps to light up the area, especially useful in dark conditions
- **Flashing green:** charging in progress
- **Solid green:** charging complete
- **Solid blue:** delayed charging toggled; changes to flashing green when charging commences
- **Solid red:** malfunction

The driver may also choose from two settings:

- **Immediate charging (the standard setting):** Starts charging as soon as the vehicle is docked for charging
- **Delayed charging:** This is especially useful for when cheaper electric rates are desired, e.g. charging at night. Simply enter a charging start time

Please note, EV range assumes that vehicle has been pre-conditioned prior to journey. This function can be accessed either via MyVauxhall App (standard with all Vivaro-e Life models or with optional Multimedia Navi Pro).

Charging		
Supply	Socket	Charge Time (0-100%)
AC current - Domestic 3 pin socket (2.3kW)	Type 2	21h 45m
AC current - Home wallbox or public charger (7kW)	Type 2	7h 30m
AC current - Public charger (11kW)**	Type 2	5h
DC current - Rapid charger (100kW)	CCS	30m (0-80%)

Battery	
Battery capacity	50kWh
AC on-board charger speed (standard)	7.4kW
WLTP Range (Combined)	129-141 miles
WLTP Range (City)	182-215 miles
Energy consumption (Combined low/high)	24.3-26.6kWh/100km
Battery warranty	8 years/100,000 miles/70% capacity



The Vivaro-e Life is a battery electric vehicle requiring mains electricity for charging. Range data given has been determined according to WLTP test procedure methodology. The figures shown are intended for comparability purposes only and should only be compared to other cars tested to the same technical standard. The range you achieve under real world driving conditions will depend upon a number of factors, including but not limited to: the accessories fitted (pre and post registration); charging frequency; personal driving style; vehicle load and route characteristics; variations in weather; heating/air conditioning; pre-conditioning and battery condition. For more information, contact your local Vauxhall Retailer.

*Provisional data. **Requires optional 11kW on board charger.

Dimensions and Capacities All measurements in mm (inches) unless stated otherwise.

Loadspace Dimensions	M (Medium)	L (Long)
Maximum load length – Passenger’s seat folded	3161 (124.5)	3511 (138.2)
Maximum load length – Behind front seats	2413 (95.0)	2763 (108.8)
Maximum width	1618 (63.7)	1618 (63.7)
Width between wheel arches	1228 (48.3)	1228 (48.3)
Maximum height	1337 (52.6)	1339 (52.7)
Loadspace Access		
Side door aperture height	1181 (46.5)	1181 (46.5)
Side door aperture width	933 (36.7)	933 (36.7)
Rear door aperture height	1181 (46.5)	1181 (46.5)
Rear door aperture width	1212 (47.7)	1212 (47.7)
Loading height – Maximum	653 (25.7)	664 (26.1)
Loading height – Minimum	584 (23.0)	584 (23.0)
Loadspace Volumes cu.m (cu.ft.)		
Maximum volume to roof level	3.9 (137.7)	4.5 (158.9)
Maximum volume to seat back level	3.0 (105.9)	3.5 (123.6)

M (Medium)



L (Long)

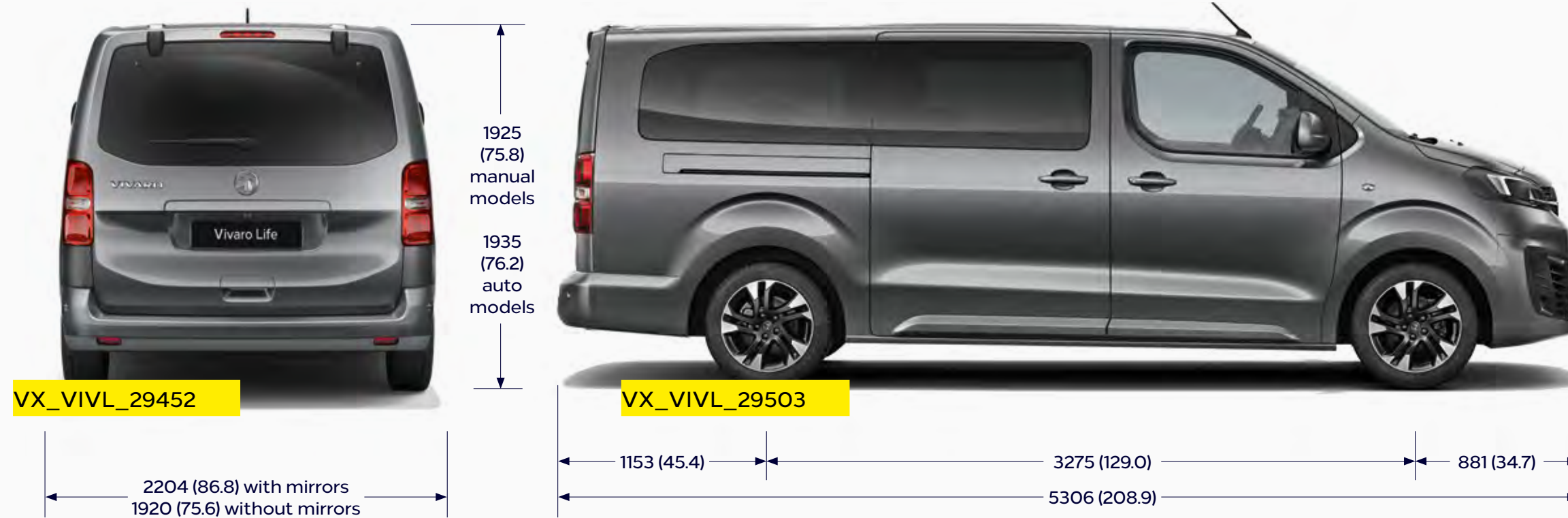

Accessories

Safety	Total (inc. VAT)	Protection	Total (inc. VAT)	Comfort	Total (inc. VAT)	Transport solutions	Total (inc. VAT)
Spare wheel kit with 16-inch emergency wheel, tool kit and mounting basket (Diesel models only)	£257	Rubber mat for first row	£20	USB charger – 2 front and 2 rear ports	£28	Aluminium roof bar – single (2 or 3 needed)	£150
Philips ADR620 dash cam	£109	Carpet mat for		Wind deflectors for front doors (set of 2)	£82	Roof carriers (requires base carrier)	
Front parking sensors	£390	– First row	£73	FlexConnect bracket	£20	Roof box – Thule Ocean 80	£164
Rear parking sensors	£407	– Second row	£59–65	FlexConnect hook	£37	Roof box – Thule Ocean 200	£374
Front fog lamps kit	£552	– Third row	£59	FlexConnect coat hanger	£41	Roof box – Thule Touring 200	£428
Child seats ¹		Anti-slip, water-resistant boot liner	£81	FlexConnect folding table	£102	Roof box – Thule Touring 700	£492
– Group 0 (0-13kg) – Britax Romer Baby Safe	£239	Boot liner carpet	£39–56	FlexConnect iPad Mini holder	£127	Roof box – Thule Motion 800	from £426
– ISOFIX Base, Rear-facing for Britax Romer Baby Safe	£251	Waterproof boot cover in coated cloth	£54	FlexConnect iPad holder	£106	Bike carrier – Thule FreeRide 532	£81
– Group 2/3 (15-36kg) – Britax Romer KIDFIX 2 R	£317	Waterproof rear seat cover in coated cloth	£40	FlexConnect iPad Air holder	£106	Bike carrier – Thule Expert 298	£134
– Group 2/3 (15-36kg) – Britax Romer KIDFIX XP	£352	Cargo net	£30	FlexConnect Samsung Galaxy 10.1 holder	£127	Surfboard carrier – Thule 833	£84
– Group 3 (22-36kg) – Booster Seat without Seatback	£76	Rear bumper protector	£38	Cupholder organisers	£8–10	Kayak carrier – Thule Hull-a-Port Pro 837	£234
Safety Pack – first aid kit, hi-vis vest and warning triangle	£16	Front and rear splash guards	£131	Smoker's kit	£53	Ski/snowboard carrier	
Warning triangle	£9			Fragrance diffuser	£24	– Thule Snow Pack 7324 (4 x pairs)	£147
Hi-vis safety vest – adult	£4	Style		Fragrance cartridge (various)	£18	Ski/snowboard carrier	
Hi-vis safety vest – child 3–6 years (42cm)	£4	5-speed gear lever knob				– Thule Snow Pack 7326 (6 x pairs)	£265
Hi-vis safety vest – child 7-12 years (52cm)	£4	– Black chrome and leather	£75	Electrical		Towing	
First aid kit	£15	– Chrome and leather	£75	Mode 2 emergency charging cable (Type G – UK domestic plug)	£584	Swan's neck towing ball and 13-track wiring loom	£627
Emergency seat belt cutter and hammer	£19	6-speed lever knob		Mode 3 charging cable		Tow bar without tow ball and 13-track wiring loom	£627
Fire extinguisher with strap		– Satin chrome	£69	– 7.4kW	£331	Tow bar with removable tow ball and 13-track wiring loom	£765
– 1kg	£23			– 11kW	£371	13-pin to 7-pin adapter	£30
– 2kg	£32			– 22kW	£438		
				Cable bag	£49		
				Mode 2 Universal Charger UK kit (22kW)	£1,555		
				Accessories for Universal Charger			
				– Wall bracket	£105		
				– Bag	£65		
				– Safety lock	£20		
				– Adapter Type 2	£318		
				– Adapter Type 3c	£358		
				– Adapter (various)	£120		

Please note: Prices shown are fully fitted and painted, where applicable and include VAT. Please check with your local Vauxhall Retailer for details. It is advisable to ensure your insurance policy is adequate to cover additional fitted accessories. Prices correct at time of publication.

¹Restrictions apply to the use of child seats, please consult your vehicle user manual or Vauxhall Retailer.

Company Car Driver and Fleet Information

Benefit in kind company car taxation*

The car benefit charge will be the car's list price (including VAT, options and accessories fitted, delivery to Retailer and number plates, but excluding Vehicle Excise Duty and new vehicle first registration fee) multiplied by the percentage charge for the CO₂ emissions band in which the car falls (see table opposite). Multiply this figure by your personal income tax rate (20%** for Basic Rate, 40%** for Higher Rate) to calculate your annual benefit in kind tax liability.

Generic example:

ELECTRIC vehicle: 0g/km CO₂

On-the-road RRP	£27,305.00
Deduct: Vehicle Excise Duty	£0.00
New vehicle first registration fee	-£55.00
Effective list price	£27,250.00
Add: Optional two-coat metallic paint	£600.00
List price for tax purposes (P11D value)	£27,850.00
Car benefit charge 2022-23 tax year (2%)	£557.00
Benefit in kind tax liability	
Basic Rate (20%) tax payer	£111.40
Higher Rate (40%) tax payer	£222.80

*Please note this Price Guide provides taxation information as a guide only. Vauxhall does not provide taxation guidance. Drivers should always take professional advice on their own tax position.

**Excludes residents of Scotland.

BiK for Scottish Residents

Effective 6 April 2018 the Scottish Government have introduced their own BiK taxation structure. This only applies to Company Car Drivers that are Scottish taxpayers. HMRC will determine whether or not an individual is a Scottish taxpayer based on where their main place of residence is.

The BiK rates for Scotland are:

- Over £12,570 - £14,732 Starter Rate 19%
- Over £14,732 - £25,688 Basic Rate 20%
- Over £25,688 - £43,662 Intermediate Rate 21%
- Over £43,662 - £150,000 Higher Rate 41%
- Above £150,000 Top Rate 46%

CO ₂ emissions (g/km)	Electric range (miles)	Percentage of cars price to be taxed 2022-23 tax year
0	-	2%
1-50	130+	2%
1-50	70-129	5%
1-50	40-69	8%
1-50	30-39	12%
1-50	<30	14%

To calculate your own personal liability, search: **Vauxhall BiK**, or click the link below:

[Vauxhall BiK Tool](#)

Fleet Toolbox

Discover the facts in our online Toolbox for both Company Car Drivers and Fleet Decision Makers. The Fleet Toolbox has a host of useful calculators, comparators, interactive listings and information.

Search Vauxhall Fleet Tools or click the link below:

[Vauxhall Fleet Tool Box](#)

Contact Vauxhall Fleet

Please contact one of our dedicated sales teams who will be happy to help with your particular enquiry.

Company Car Drivers

Call: 0345 111 2020

Email: company-car@vauxhallinfo.co.uk

Telephone lines are open

- Monday to Friday 8:00am-9:00pm

- Saturday and Sunday 9:00am-6:00pm

Fleet Decision Makers

Depending on the size of your fleet of vehicles, we have a dedicated team to handle your enquiries. The lines are open Monday to Friday excluding Bank Holidays.

1-24 vehicles

Call: 0845 076 2254 (8:30am-5:00pm)

25+ vehicles

Call: 0330 587 8222 (8:30am-5:00pm)

Email: vauxhallfleet@vauxhall.co.uk

Special Vehicles (Police, Fire and Ambulance)

Call: 01582 409999 (8:30am-5:00pm)

Email: vauxhallspecialvehicles@vauxhall.co.uk

Further Information

On-the-road prices

To eliminate uncertainty about hidden costs when buying a new car, Vauxhall publishes on-the-road recommended retail prices (RRP) and these are shown in the pricing tables within this price guide. These prices include VAT, number plates and delivery to Retailer of £700.00 (including £116.67 VAT), 12 months' Government Vehicle Excise Duty (see opposite for details) and the DVLA new vehicle first registration fee of £55.00.*

Please note: The on-the-road recommended retail price (RRP) does not include fuel supplied by the Retailer, motor insurance or any other goods or services supplied by agreement between the Retailer and the customer.

Price protection

Order a new Vauxhall for build in the current model year (as confirmed by your Retailer) for delivery no more than three months in advance and the price you are quoted is the price you pay. This is irrespective of any subsequent price rises between placing your order and delivery of your new car, but you must take delivery as soon as the car is available.

Please note: Price protection does not apply to electric/hybrid models. Vauxhall Motors Limited is not liable for price adjustments caused by Government changes in the rate of VAT (currently 20%), Vehicle Excise Duty, DVLA new vehicle first registration fee or by any other applicable legislation or regulations.

In the event of an accident

Vauxhall Accident Management helps keep you mobile following an accident. Benefits include vehicle recovery, Vauxhall-approved repairs and contacting your insurer. For more details, visit vauxhall.co.uk/AccidentManagement

Free2Move Lease

Whether you're a big company or a small business looking for vehicle financing, Free2Move Lease, our business finance specialists, can deliver exactly what you need.

Free2Move Lease is one of the UK's largest leasing companies and is also a member of the British Vehicle Rental and Leasing Association (BVRLA).

With over 60,000 vehicles in the Free2Move Lease portfolio, Free2Move Lease is able to offer competitive vehicle solutions. In addition, Free2Move Lease also offer innovative connected management of servicing and maintenance.

For further information, please contact your local Vauxhall Retailer or visit vauxhall.co.uk/offers-finance/business-leasing.html

Vehicle Excise Duty

The amount of Vehicle Excise Duty (road fund licence) payable on new cars varies depending on the level of carbon dioxide (CO₂) emissions produced by the vehicle. CO₂ emissions are measured in grams per kilometre (g/km) travelled and divided into 13 charging bands shown in the table opposite.

A 'first year rate' of Vehicle Excise Duty is payable on all new cars and in subsequent years the amount payable reverts to the 'standard rate'. From 1 April 2017 the breakpoints for each of these bands have been revised. Also, for vehicles with a list price over £40,000, including factory-fitted options, an additional £335 is payable for the first five years of standard rate payments.

Vehicle Excise Duty*

Band	CO ₂ emissions in grams per kilometre	Standard rate Electric
A	0	£0
B	1 – 50	-
C	51 – 75	-
D	76 – 90	-
E	91 – 100	-
F	101 – 110	-
G	111 – 130	-
H	131 – 150	-
I	151 – 170	-
J	171 – 190	-
K	191 – 225	-
L	226 – 255	-
M	Over 255	-

*Correct at time of issue.

Further Information

Customer Care Commitment

For added peace of mind, Vauxhall has an innovative Customer Care Commitment that offers the following:

- Three-year vehicle warranty consisting of a one-year/unlimited mileage manufacturer's warranty and a second and third year manufacturer's warranty with a 60,000 miles limitation
- Vauxhall Assistance for 12 months from first registration
- Six years' body panel anti-perforation warranty

Please note: Warranty is only available on vehicles sourced from Vauxhall Motors Limited. Terms and conditions apply – please see your Vauxhall Retailer for details.

Vauxhall Assistance

Vauxhall Assistance is provided automatically with every new Vauxhall for 12 months from first registration and covers everything from accident assistance, roadside recovery and 'at home' service to flat tyres. For even more peace of mind, on Vivaro-e life models the cover is extended* to 8 years or 100,000 miles, whichever comes first. Even more reason for you to stay calm and let us take care of everything should the need arise. With Vauxhall Assistance help is literally just a free** phone call away, 24 hours a day, 365 days a year!

Protecting the environment

Vauxhall's commitment to the environment is demonstrated by our products' many environmental awards. For even more information on Vauxhall's efforts to achieve an environmentally sustainable future, and how to dispose of your end-of-life vehicle, see vauxhall.co.uk/recycling

Vauxhall Care

This all-inclusive service package is available on Vauxhalls under 10 months old (from date of first registration).

This package offers complete peace of mind for the first 3 years of your Vauxhall's life with fixed monthly payments for the plan duration.

- **3 years' Vauxhall servicing** – covers first, second and third annual services. Including a brake-fluid change in the second service
- **2 years' Vauxhall Roadside Assistance** – first year from us
- **First years' MOT[†]** – free of charge by your local Vauxhall Retailer

For full terms and conditions and to sign up, visit: vauxhall.co.uk/vauxhallcare

Vauxhall Service Club

Vauxhall Service Club is available for all Vauxhall owners, and it's free to join. Members benefit from the following:

- 15% off Vauxhall Approved Accessories
- Vauxhall's aged 2-3 Years = 15% off parts and labour
- Vauxhall's aged over 3 Years = 25% off parts and labour
- Half price MOT's (NI excluded)
- Free pre-MOT test inspection (NI only)
- Fixed price AdBlue[®] Refills
 - Car = £14.99
 - Van = £24.99
- Access to the Vauxhall Accident Management Programme
- Online service booking available 24/7 with servicing appointments available within 3 days – [Book Online](#)
- Collection and delivery/onward mobility options
- Complimentary 'Wash and Vac' with all routine services^{††}
- Vauxhall trained technicians
- Genuine Vauxhall parts
- Minimum 12 months warranty on parts and labour
- Regular newsletters with exclusive offers, discounts and competitions

Terms and conditions apply. To join visit: vauxhall.co.uk/serviceclub

Vauxhall Insurance with added reassurance

Comprehensive cover – Summary of benefits

- Competitive premiums
- Repairs by a Vauxhall-trained technician
- Genuine Vauxhall parts, guaranteed for five years when we repair your car within our Approved Repairer Network
- Free courtesy car as standard when using an Approved Repairer[‡]
- 24 hour claims helpline
- Personal Accident benefit
- Cover for audio equipment
- Windscreen cover

Call for a quote on 0330 678 1130^{‡‡}

For more product information

For further information on the Vauxhall range or location of your nearest Vauxhall Retailer please call 0345 600 1500. Alternatively, details can be found on our website at vauxhall.co.uk

For more information call **0345 600 1500**

For Fleet enquiries call **0330 587 8222**

Discover the full Vauxhall range at **[vauxhall.co.uk](https://www.vauxhall.co.uk)**

Join us online

The invoice price, including delivery to Retailer, factory-fitted options, accessories fitted by the Retailer and number plates, is subject to VAT. Some feature descriptions in this guide may refer to, and some illustrations may show, optional equipment not included in the standard delivery. The information contained in this guide was accurate at the time of publication. We reserve the right to make changes in design and equipment. Please note that Vauxhall Retailers are not the agents of Vauxhall Motors Limited and are not authorised to bind Vauxhall Motors Limited by any specific or implied undertaking or representation. It is advisable to ensure that your motor insurance policy provides adequate cover for additional fitted options and accessories. The colours in this guide are only approximate actual colours. Illustrated optional equipment is available at extra charge. Availability, technical features and equipment provided on our vehicles can vary by model. For precise information on the equipment provided on our vehicles, please contact your local Vauxhall Retailer.

VAUXHALL